



---

# ***ULTRA TWIN (UL)***

## **INSTRUCTION MANUAL**



# ULTRA TWIN (UL) (SECOND EDITION REV 3)

February 2020

Part Number M-192-6-002-3U

## COPYRIGHT

© Pulsar Process Measurement Limited, 2005 - 20. All rights reserved. No part of this publication may be reproduced, transmitted, transcribed, stored in a retrieval system, or translated into any language in any form without the written permission of Pulsar Process Measurement Limited.

## WARRANTY AND LIABILITY

Pulsar Process Measurement Limited guarantee for a period of 2 years from the date of delivery that it will either exchange or repair any part of this product returned to Pulsar Process Measurement Limited if it is found to be defective in material or workmanship, subject to the defect not being due to unfair wear and tear, misuse, modification or alteration, accident, misapplication or negligence.

## DISCLAIMER

Pulsar Process Measurement Limited neither gives nor implies any process guarantee for this product and shall have no liability in respect of any loss, injury or damage whatsoever arising out of the application or use of any product or circuit described herein. Every effort has been made to ensure accuracy of this documentation, but Pulsar Process Measurement Limited cannot be held liable for any errors.

Pulsar Process Measurement Limited operates a policy of constant development and improvement and reserves the right to amend technical details as necessary. The Ultra Twin units shown on the cover of this manual is used for illustrative purposes only and may not be representative of the actual Ultra Twin unit supplied.

## COMMENTS, SUGGESTIONS AND TECHNICAL ENQUIRIES

Please contact Pulsar Measurement if you have any comments, suggestions or if you require technical support using the information below:

### UK Office

Pulsar Process Measurement Ltd.  
Cardinal Building  
Enigma Business Centre  
Sandy's Road  
Malvern  
Worcestershire  
WR14 1JJ  
United Kingdom

Tel: +44 (0) 1684 891371  
Fax: +44 (0) 1684 575985

Website:

[www.pulsar-pm.com](http://www.pulsar-pm.com)

General Information email:  
[info@pulsar-pm.com](mailto:info@pulsar-pm.com)

Technical Support email:  
[support@pulsar-pm.com](mailto:support@pulsar-pm.com)

### Canada Office

Greyline Instruments Inc.  
16456 Sixsmith Drive  
Long Sault  
ON  
K0C 1P0  
Canada

Tel: 613-938-8956  
Toll Free: 855-300-9151  
Fax: 613-938-4857

Website:

[www.greyline.com](http://www.greyline.com)

General Information email:  
[info@greyline.com](mailto:info@greyline.com)

Technical Support email:  
[service@greyline.com](mailto:service@greyline.com)

### USA Office

Greyline Instruments Inc.  
11451 Belcher Road South  
Largo  
FL 33773  
USA

Tel: 315-788-9500  
Tax Free: 888-473-9546  
Fax: 315-764-0419

Website:

[www.greyline.com](http://www.greyline.com)

General Information email:  
[info@greyline.com](mailto:info@greyline.com)

Technical Support email:  
[service@greyline.com](mailto:service@greyline.com)



# Contents

Chapter 1 Start Here.....	1
About this Manual.....	1
About the <i>Ultra Twin</i> .....	2
Functional Description.....	2
Product Specification.....	4
EU Declaration of Conformity .....	6
Chapter 2 Installation.....	7
Unpacking.....	7
Power Supply Requirements.....	7
Safety Symbols.....	7
Location .....	8
Dimensions .....	9
Wall mount .....	9
Fascia Mount .....	12
Terminal Connection Details.....	14
Wall Mount.....	14
Fascia Mount .....	15
Fuse Location .....	21
Wall mount .....	21
Fascia mount.....	21
Preparation for Operation.....	22
Maintenance.....	23
Chapter 3 How To Use Your Ultra Twin.....	24
Operating the Controls .....	24
Display .....	24
Run Mode .....	26
Program Mode.....	26
How to Access Program Mode.....	27
Test Mode.....	32
Using the RS232 Serial Interface.....	33
Parameter Defaults .....	35
Factory Defaults.....	35
Chapter 4 Quick Setup Guide .....	36
Level or Volume.....	37
Example 1 Level Monitoring with Alarms .....	43
Example 2 Level Monitoring and Control (up or down).....	45
Example 3 Volume Application .....	47
Example 4 : Differential Control.....	49
Pump.....	53
Example 1 Sump Control (pump down) .....	58
Example 2 Reservoir Control (pump up) .....	60
Flow .....	62
Exponential Devices.....	69
Point of Measurement .....	70
Calculations.....	72
Example 1 'V' Notch Weir .....	74
BS3680 Flumes .....	76
Point of Measurement .....	76
Calculations.....	77
Example 2 BS3680 U-Throated Flume.....	79

BS3680 Thin Plate Weirs.....	81
Point of Measurement .....	81
Calculations.....	81
Example 3 BS3680 Rectangular Weir.....	83
BS3680 Rectangular Broad Crested Weir.....	85
Point of Measurement .....	85
Calculations.....	85
Special Devices.....	86
Point of Measurement .....	86
Calculations.....	87
Universal Calculations .....	88
Point of Measurement .....	88
Calculations.....	88
Chapter 5 Parameter Guide.....	90
Menu System Diagrams.....	90
Top Level Menu .....	90
Application Menu.....	91
Relays Menu.....	92
Pump “Advanced” .....	93
Digital Inputs.....	94
Data Logs.....	95
Volume Menu .....	96
OCM Menu.....	97
Display .....	98
mA Output 1 Menu .....	99
mA Output 2 Menu .....	99
Compensation .....	100
Stability Menu.....	100
Echo Processing Menu .....	101
System Menu.....	102
Device Comm Menu .....	103
Test Menu .....	104
Chapter 6 Parameter Listing and Description.....	105
Application Parameters .....	105
System Units.....	105
Operation.....	105
Dimensions .....	107
Relay Parameters.....	109
Alarms.....	110
Pumps.....	118
Control.....	122
Miscellaneous .....	127
Common Parameters .....	129
Pump “Advanced” Parameters .....	130
Pump Run On .....	130
Starting .....	130
Stopping .....	131
Pump Exercising.....	131
Wall Cling.....	132
Digital Inputs .....	133
About Digital Inputs .....	133
Digital Input Parameters.....	139
Common Par.....	139
Digital Inputs.....	141
Data Log Parameters .....	144

Totaliser Audits.....	144
Temperature.....	144
Pump Logs.....	145
Volume.....	146
Conversion.....	147
Breakpoints.....	151
Tables.....	152
OCM Parameters.....	153
PMD Setup.....	153
Dimensions.....	156
Calculations.....	159
Breakpoints.....	160
Tables.....	161
Average Flow.....	161
Display Parameters.....	161
Options.....	161
Failsafe.....	163
Auxiliary.....	164
Totaliser.....	166
Bargraph.....	168
mA Output 1 Parameters.....	169
Range.....	169
Operation.....	169
Setpoint.....	170
Limits.....	171
Trim.....	171
Failsafe.....	172
Allocation.....	172
mA Output 2 Parameters.....	174
Range.....	174
Operation.....	174
Setpoint.....	175
Limits.....	176
Trim.....	176
Failsafe.....	177
Allocation.....	177
Compensation Parameters.....	179
Offset.....	179
Temperature.....	179
Velocity.....	180
Stability Parameters.....	181
Damping.....	181
Indicator.....	181
Rate.....	181
Filters.....	182
Echo Processing Parameters.....	183
Transducer 1 Status.....	183
Transducer 2 Status.....	184
System Parameters.....	185
Passcode.....	185
Backup.....	185
System Information.....	186
Date & Time.....	187
LED Colour.....	187
Watchdog.....	188
Daylight Saving Time.....	189
Device Comm.....	192

RS232 Set Up .....	192
RS 485 Set Up (Optional) .....	192
Remote Alarm.....	193
Test Parameters.....	194
Simulation .....	194
Test Setup.....	195
Hardware.....	196
Chapter 7 Troubleshooting .....	198
Chapter 8 Disposal.....	199
Notes .....	200
Notes Continued.....	201



Congratulations on your purchase of a Pulsar *Ultra Twin*. This quality system has been developed over many years and represents the latest in high technology ultrasonic level measurement and control.

It has been designed to give you years of trouble free performance, and a few minutes spent reading this operating manual will ensure that your installation is as simple as possible.

### **About this Manual**

It is important that this manual is referred to for correct installation and operation.

There are various parts of the manual that offer additional help or information as shown.

#### **Tips**



#### **TIP**

At various parts of this manual you will find tips to help you.

#### **Additional Information**

##### **Additional Information**

At various parts of the manual, you will find sections like this that explain specific things in more detail.

#### **References**

— See Also

*References to other parts of the manual*

## About the *Ultra Twin*

*Ultra Twin* has two independent points of measurement, the wall mount model provides a dedicated display to each point of measurement, whilst the fascia model, whilst in RUN, will show detail of one point of measurement in the main display line, with the second point being displayed on the auxiliary display line. In both models the display will provide information relevant to the point of measurement selected whilst in **RUN** and **PROGRAM** mode.



*Ultra Twin* combines premium specification with high performance in a most versatile system which is quickly configurable offering a choice of applications in any combination, between the two points of measurement, of three specific applications i.e. level or volume measurement, pump control or flow measurement.

### Functional Description

*Ultra Twin* sends a transmit pulse to the transducer(s), which emits an ultrasonic pulse perpendicular to the transducer face, and the returned echo is sent back to the *Ultra Twin*. The time taken to receive the echo is measured and the distance from the transducer face to the surface being monitored is calculated.

*Ultra Twin* can measure from zero to 131 feet (40m) from the transducer to the surface being monitored, dependent on the application chosen and transducer used.

Six user-definable relays can be programmed to activate alarms, pump starters, or other control equipment, and can be allocated to either point of measurement. Also provided are four user definable digital inputs on the wall mount model and seven on the fascia mount model, which can be allocated to either point of measurement. There is an isolated 4-20 mA output for each point of measurement that can be connected to a recorder or PLC, to monitor **level space, distance, volume, OCM head or flow** (dependant on the application chosen), independently from that shown on the display. There is an RS232 port, so that the *Ultra Twin* can be operated remotely by a PC or other equipment.

*Ultra Twin* can be programmed either by the built-in keypad (standard), or by PC via the RS 232 Serial Interface (optional).

All parameters are stored in non-volatile memory, so are retained in the event of power interruption. A second backup copy of all parameters can also be retained in the *Ultra Twin* memory, in case an alternative set of parameters needs to be stored.

The system utilises the unique DATEM software (**D**igital **A**daptive **T**racking of **E**cho **M**ovement). This is a proven digital mapping technique developed especially for the Pulsar *Ultra* range, which gives the system unequalled ability when identifying the “true target level” in the face of competing echoes from pipes, pumps or other obstructions. Coupled with the powerful, long-range abilities of the ‘all new’ dB transducer range, the *Ultra Twin* lives up to its reputation as the most reliable ultrasonic level measurement system available.

The Pulsar *Ultra Twin* ultrasonic level controller has been designed to provide maintenance-free fit and forget performance.

## Product Specification

### Physical

<b>Wall Mount</b>	
<b>Overall Outside dimensions</b>	9.25 x 7.24 x 4.72 inch (235 x 184 x 120 mm)
<b>Weight</b>	Nominal 2.2lbs (1 kg)
<b>Enclosure material/description</b>	Polycarbonate, flame resistant to UL94-5V
<b>Cable entry detail</b>	10 cable entry knock outs, 5 x M20, 1 x M16 underside 4 x PG11 at rear
<b>Fascia Mount</b>	
<b>Outside dimensions</b>	7.87 x 4.41 x 4.25 inch (200 x 112 x 108 mm)
<b>Weight</b>	Nominal 2.8lbs (1.3kg)
<b>Enclosure material/description</b>	Stainless Steel back, Polycarbonate UL94-V0 front and bezel
<b>Transducer cable extensions</b>	3-conductor 20AWG screened
<b>Maximum separation</b>	3,280 ft (1000m), 1,640 ft (500m) for dBR16 & dBR8

### Environmental

<b>Mounting - Wall Mount</b>	Indoor/Outdoor
- Fascia Mount	Indoor
<b>Relative Humidity (IP Rating)</b>	
- Wall Mount	IP65 (NEMA 4X) when closed IP20 when open
- Fascia Mount	(IP64 from front of panel) <35°C (95°F) at 93% relative humidity Pollution Degree 2 2000m maximum
<b>Altitude</b>	
<b>Max. &amp; min. temperature (electronics)</b>	-4°F to 120°F (-20 °C to +50 °C)
<b>Flammable atmosphere approval</b>	Safe area: compatible with approved dB transducers (see transducer spec' sheet)

### Approvals

<b>UL</b>	Certificate Number E257330
<b>CE approval</b>	See EU Declaration of Conformity

### Performance

<b>Accuracy</b>	0.25% of the measured range or 0.24" (6 mm) (whichever is greater)
<b>Resolution</b>	0.1% of the measured range or 0.08" (2 mm) (whichever is greater) ± 2mm for dBR16 & dBR8
<b>Max. range</b>	Dependant on application and transducer (maximum 131ft (40m) dB40)
<b>Min. range</b>	Dependent upon application and transducer (minimum zero dB Mach3)
<b>Rate response</b>	fully adjustable

## *Echo Processing*

**Description** DATEM (Digital Adaptive Tracking of Echo Movement)

## *Outputs (x2)*

**Analogue output** Isolated (floating) output (to 150V) of 4-20 mA or 0-20 mA into 500Ω (user programmable and adjustable) 0.1% resolution

**Digital output** Full Duplex RS232  
**Volt free contacts, number and rating** 6 form "C" (SPDT) rated at 5A at 115V AC

## *Digital Inputs*

**Wall Mount x4** Min. Input Voltage 4.5VDC  
**Fascia Mount x7** Max. Input Voltage 30VDC (Max Current 3mA)  
24VDC Input Supply maximum total current 24mA.

**Displays**  
**Wall mount x2** 6 digits plus 12-character text, plus bar graph with direction indicators, remote communicator identifier, and program/run/test mode indicators  
**Fascia Mount x1**

## *Programming*

**On-board programming** By integral keypad  
**PC programming** via RS232  
**Programming security** Via passcode (user selectable and adjustable)  
**Programmed data integrity** Via non-volatile RAM, plus backup

## *Supply*

**Power supply** 115V AC + 5% / -10% 50/60 Hz, dc 18 - 30V (If using a battery then 24V minimum 1AH, dependant on life required, externally fused with 1A fast blow fuse.  
10W maximum power (typically 6W)  
II

**Overvoltage Category**  
**Fuses**  
**Mains (F1)** 125 mA T at 115 VAC  
**DC (Battery) (F2)** 1A Thermal (self resetting after power removed). Not user replaceable  
**Transducer (F3, F5 Ch.1 & F4, F6 Ch. 2)** Littelfuse 242 series 100mA Part No. 0242.100. This fuse is not user replaceable and has a 4000A breaking capability to comply with certification of the Exm version of dB series transducers.

Pulsar Process Measurement Limited operates a policy of constant development and improvement and reserve the right to amend technical details as necessary.

## EU Declaration of Conformity

---



### EU DECLARATION OF CONFORMITY

#### P U L S A R Ultra Twin

This declaration of conformity is issued under the sole responsibility of the manufacturer

---

Relevant Directive(s)	2014/30/EU - EMC Directive and its amending directives 2014/35/EU - Low Voltage Directive and its amending directives 2011/65/EU - RoHS Directive and its amending directives
Manufacturer's Name	Pulsar Process Measurement Ltd
Manufacturer's Address	Cardinal Building, Enigma Business Commercial Centre, Sandy's Road, Malvern, Worcestershire, WR14 1JJ, UK
Apparatus	Pulsar Ultra Twin Wall & Fascia, dB Transducer series
Type of Equipment	Measurement and process control
Standards Applied	EN 61010-1 Safety requirements for electrical equipment for measurement, control, and laboratory use EN 61326-1:2013 Equipment class, industrial

Signed   Name: Jeff Allan (BSc.) Engineer Pulsar Process Measurement Ltd	Date: 20 <sup>th</sup> June 2017 Rev 4.0
---	--

### Unpacking

#### Important Information

All shipping cartons should be opened carefully. When using a box cutter, do not plunge the blade deeply into the box, as it could potentially cut or scratch equipment components. Carefully remove equipment from each carton, checking it against the packing list before discarding any packing material. If there is any shortage or obvious shipping damage to the equipment, report it immediately to Pulsar Process Measurement Limited.





### Power Supply Requirements

The *Ultra Twin* can operate from AC supply or from a DC battery and is designed for use in temperatures between -4°F to +140°F (-20°C to +50°C). The AC is **115 +5% / -10% 50/60Hz**. The DC is **18-30V**. In all cases the *Ultra Twin* will typically consume 6W of power, with a maximum of 10W. If *Ultra Twin* has both an AC and DC supply available then the AC supply source will be automatically sensed and used, should the AC supply be removed for any reason then the DC supply will take over.

The AC and DC wiring should be completed using either 16 – 14AWG (1.5–2.5mm<sup>2</sup>) stranded or 16 – 14AWG (1.5–4mm<sup>2</sup>) solid wire, with all terminals being tightened to 4.5in. lbs. (0.5Nm). An external supply isolator/circuit breaker (AC or DC) must be fitted near to the unit and labelled to identify the instrument to which it refers.

### Safety Symbols

Detailed below are descriptions and meanings of safety/warning symbols that are used on the *Ultra Twin* and in this manual.

	Direct Current
	Alternating Current
	Protective Conductor Terminal
	Caution (Refer to accompanying Documents)

## Location

All electronic products are susceptible to electrostatic shock, so follow proper grounding procedures during installation.

*Ultra Twin* must be mounted in a non-hazardous (safe) area, and the transducer fitted in the hazardous area.

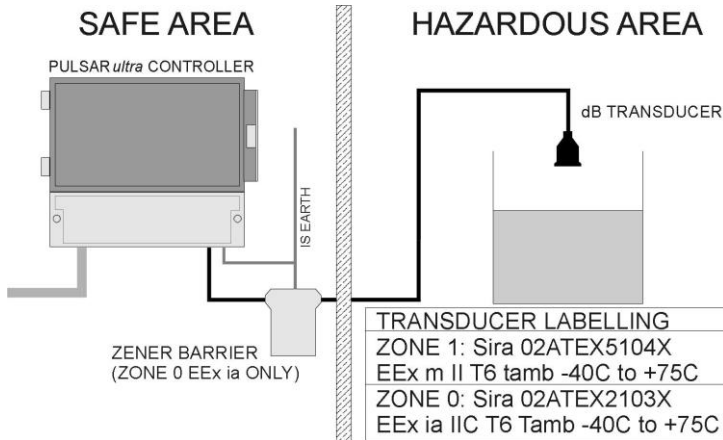

<b>FM APPROVED TRANSDUCERS</b>
Class I, Div. 1, Group A, B, C & D
Class II, Div. 1, Group E, F & G

When choosing a location to mount the enclosure, bear in mind the following:

- Ensure that the *Ultra Twin* is installed in a “Safe”, non-hazardous, area.
- For a clear view of the LCD display it is recommended that it is mounted at eye level.
- The mounting surface is vibration-free.
- The ambient temperature is between -4°F and 140°F (-20°C and 50°C).
- There should be no high voltage cables or inverters close by.



## Dimensions

### Wall mount

The dimensions of the wall fixing holes are as shown below.

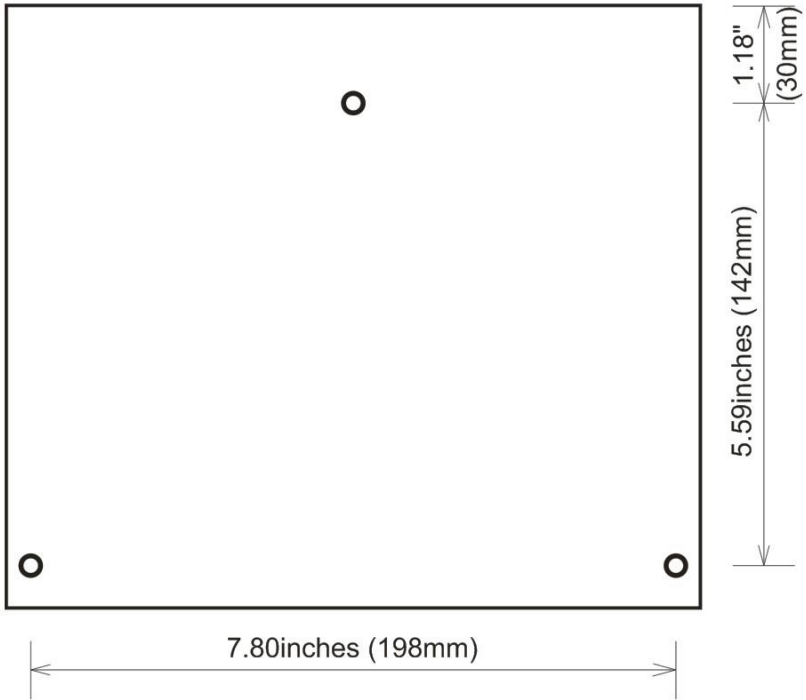

The *Ultra Twin* should be mounted by drilling three holes suitable for size 8 screws (length to suit your application) and fixing the top screw in place. Hang the unit on this and fix the two remaining screws by removing the terminals access cover to access the pre-drilled holes.

The full dimensions of the enclosure are as shown below

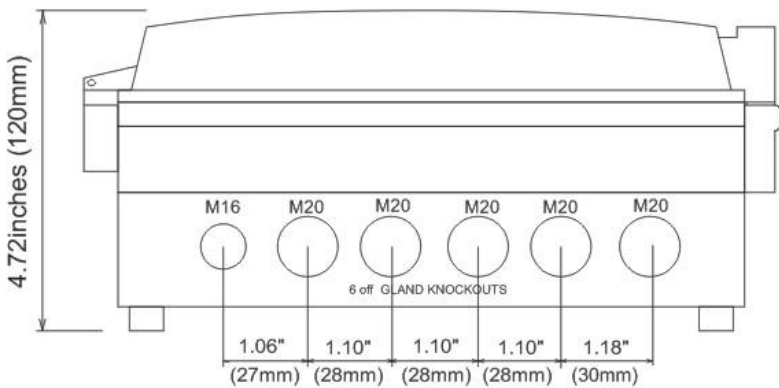
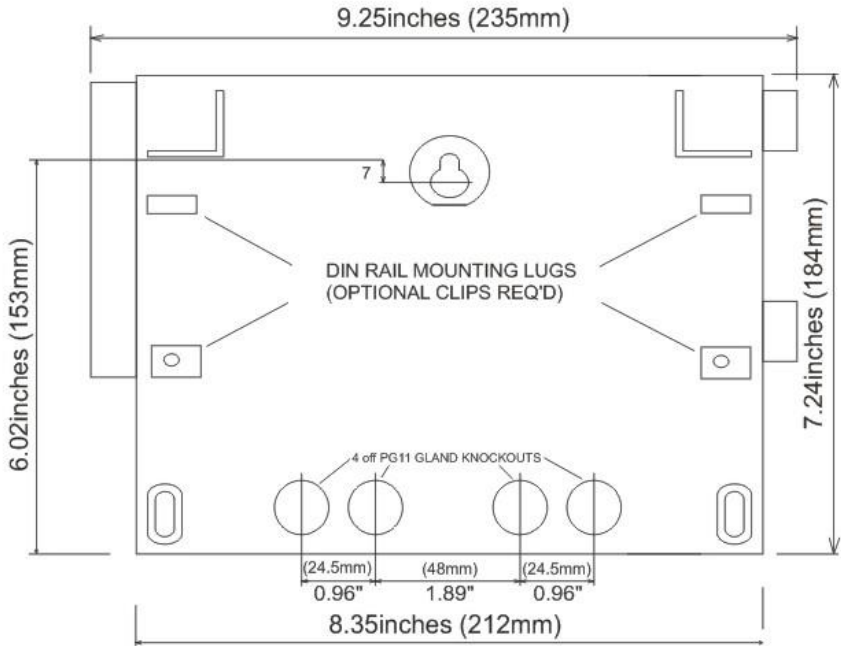

## **Cable Entry**

There are 6 cable gland knock-outs on the base of the wall mount *Ultra Twin* (5 x 0.79" (20mm), 1 x 0.63" (16mm)) and 4 on the rear (4 x 0.73" (18mm)). Select which ones you wish to use, and remove them by using a circular cutter, such as a tank cutter. Take care not to damage the circuit board inside while undertaking this. Do not use a hammer, as this may cause damage to the enclosure.

It is recommended that you use suitable cable glands to ensure that the ingress rating is maintained and that they be tightened to the manufacturers recommended settings.

### **Important Information**

All cable glands should be tightened to the manufacturer's specifications.

The terminal compartment cover screws should be tightened to 1.48lb in.(2Nm)

**Care should be taken not to over tighten the screws.**

## **Fascia Mount**

The Fascia mount *Ultra Twin* should be installed by cutting a hole in the panel, as detailed below, and securing the unit with the fixings supplied.

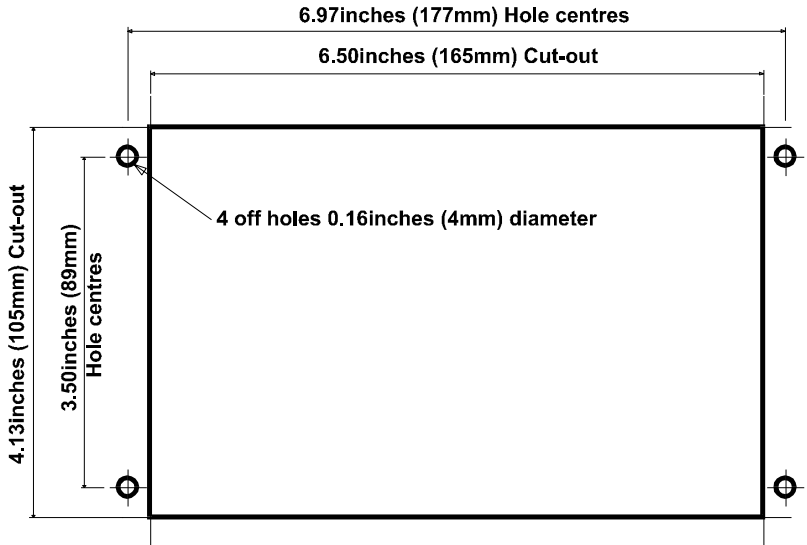

The full dimensions of the Fascia mount enclosure are as shown below.

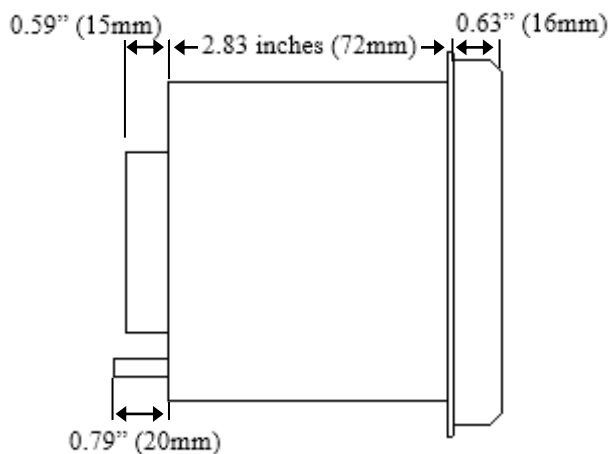
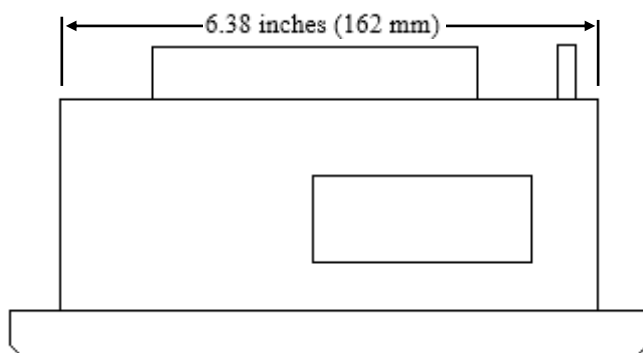
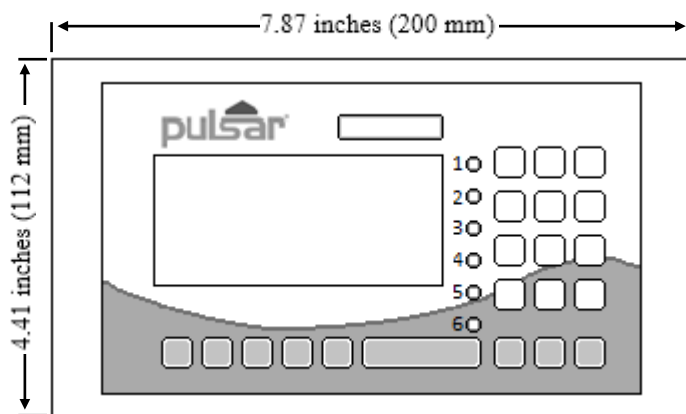

## Important Information

When mounting the fascia mount unit in to a panel, to maintain the panel IP rating the panel should be of smooth/painted finish and be machined, as per the details contained in this manual.

Fit the unit through the hole then, using the components supplied place a plain washer then a spring washer followed by an elongated nut to each of the 4 off M3 threaded studs and tighten to 2.5lb in. (0.28Nm)

**Care should be taken not to overtighten the screws.**

## Terminal Connection Details

### Wall Mount

The terminal strip is as detailed below. There is also a wiring diagram inside the terminals access cover.

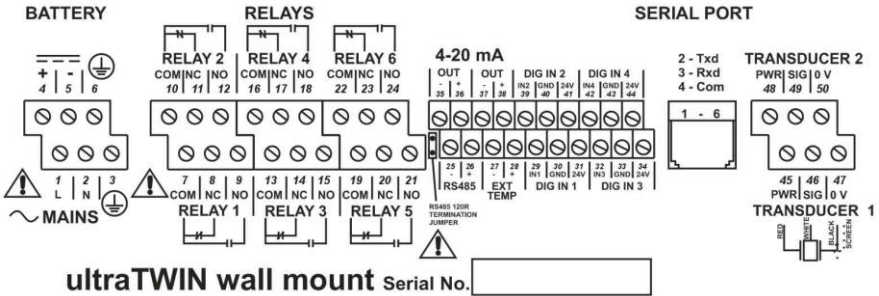

# Fascia Mount

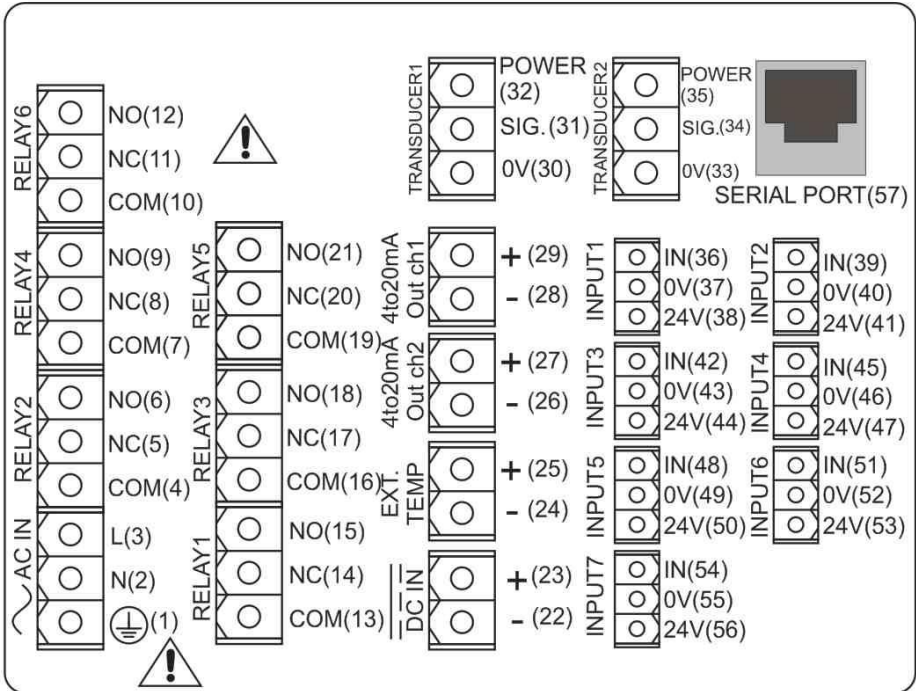

## **Terminal Connections**

### **Important Information**

All terminal connection screws should be tightened to 4.5in.lbs. (0.5Nm).

**Care should be taken not to overtighten the screws.**

### ***Power***

The *Ultra Twin* can operate from mains AC and automatically from DC or battery backup in the event of power failure or can be operated permanently from DC or batteries.

### **Important Information**

The protective earth must be connected prior to any other cabling taking place. This is connected to terminal 3, on all wall mount units, and should be tightened to 4.5in.lbs. (0.5Nm). In the case of the fascia unit the earth should be connected to the stud at the rear of the enclosure and tightened to 7.4lbF (10Nm).

The AC and DC wiring should be completed using either 16 – 14AWG (1.5–2.5mm<sup>2</sup>) stranded or 16 – 14AWG (1.5–4mm<sup>2</sup>) solid wire.

An external supply isolator/circuit breaker (AC or DC) must be fitted near to the unit and labelled to identify the instrument to which it refers.



### **Transducer**

The transducer should be installed, and connected, in accordance with the installation instructions contained in the Transducer User Guide.

The entire range of, standard dB transducers are certified for use in hazardous areas and different models, for each, are available for use in Zone 1 or Zone 0.

Wire the transducer to the *Ultra Twin*'s transducer terminals, terminal numbers will depend on the unit type, as follows:

#### **Transducer 1**

	Terminal Connection Details			
Unit Type	Red Power	White Signal	Black 0 volts	Green Screen
Wall Mount	45	46	47	47
Fascia Mount	32	31	30	30

#### **Transducer 2**

	Terminal Connection Details			
Unit Type	Red Power	White Signal	Black 0 volts	Green Screen
Wall Mount	48	49	50	50
Fascia Mount	35	34	33	33

**If splicing**, it is recommended using a junction box with standard twisted, shielded pair at 20 AWG.

When using 2-core screened extension cable, the Black and Green wires of the transducer should be connected to the screen of the extension cable, which in turn should be connected to the relevant 0 volts terminal.

When installing a transducer in a hazardous area use an approved transducer, from the Pulsar dB range, suitable for the proposed application.

## FM

For **EEx m (Zone 1)** applications a transducer certified to **FM Class I Div 1 Group A, B, C & D, ClassII Div 1 Group E, F & G, Class III** is used, and must be supplied via a 1500A breaking fuse, which is fitted as standard to the blackbox level controller.

Restrictions do not use in the presence of these groups of Chemicals, Aliphatic Hydro Carbons, Ketones or Esters

For **EEx ia (I.S.)** a transducer certified to **FM Class I Div 1 Group A, B, C & D, ClassII Div 1 Group E, F & G** is used, which must be connected to the blackbox via an external Zener barrier.

## ATEX

For **EEx m (Zone 1)** applications a transducer certified to **Sira 02ATEX5104X** is used, and must be supplied via a 4000A breaking fuse, which is fitted as standard to the blackbox level controller.

For **EEx ia (Zone 0)** a transducer certified to **Sira 02ATEX2103X** is used, which must be connected to the blackbox via an external Zener barrier.

See transducer label for certification details.

### Important Information

Please note that if the output of the ultrasonic transducers used with the *Ultra Twin* are capable of emitting sound pressure levels in excess of 85dBA (above a reference sound pressure level of 20µPA), then the *Ultra Twin* must be located remote from the transducer such that a sound pressure level of 85dBA is not exceeded when standing at the *Ultra Twin* in the operators position.

### Important Information

When using the *Ultra Twin* to measure the **differential level** between the two points of measurement then **transducer one** must be located on the **upstream** side of the application.

### **Relay Outputs**

The six relays can be programmed for a variety of alarms, pump control, or other process functions and allocated to either point of measurement. The relay contacts are all rated at 5A at 115V AC.

Wiring should be completed by using suitable cable, to meet the specified 115V AC 5A contact rating, up to maximum size of 14AWG.

All connections should be such that the short circuit capacity of the circuits to which they are connected, is limited by fuses rated so that they do not exceed the relay rating.

### **Digital Inputs**

Where the *Ultra Twin* is required to provide power for a Device Input the appropriate Digital Input should be wired between the 24VDC supply terminal and the IN terminal. (TOTAL maximum current available, for all digital inputs, four on Wall Mount model and seven on Fascia Mount model, from the 24VDC supply is 24mA). When Device Inputs are self powered, connection of the device should be made between the Common terminal and the IN terminal. (Minimum Input voltage 4.5VDC, Maximum Input voltage 30VDC with a maximum current of 3mA).

### **Current Output**

There are two mA Outputs which are fully assignable, both outputs are an isolated (floating) mA output, of 4 - 20mA or 0 - 20mA, and the load should not exceed 500Ω.

### **Temperature Input**

The external temperature sensor allows more localised compensation of the measured distance due to changes in temperature.

There are two models, Type A and Type B as follows:

Type A	-25°C to 50°C
Type B	-25°C to 125°C

The temperature sensor should be placed close to the point of measurement.

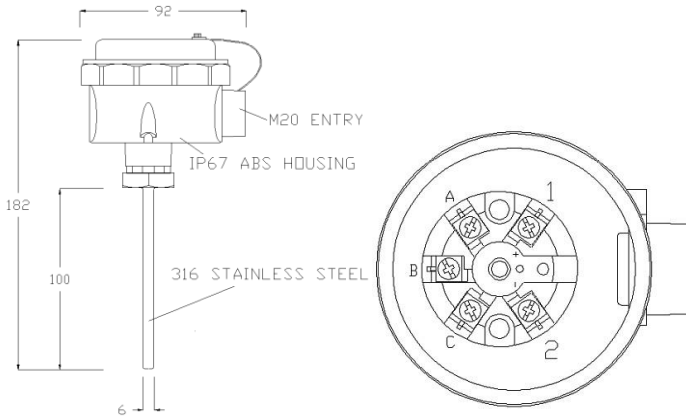

The unit is connected as follows:

Description	Temperature Sensor	Ultra Twin
Power Supply	Terminal 1	Terminal 27
Return	Terminal 2	Terminal 28

**Temp Source** (P1-852, P2-852), should be set to option 4 or 5 depending on the sensor range, set 4 for type A and 5 for type B (see above), the range is specified on the label of the sensor.

**RS232 Serial Interface**

If required, you can connect to the serial interface, to operate your *Ultra Twin* remotely.

## Fuse Location

### Wall mount

The mains fuse is located, inside the terminal compartment, to the left of the mains terminals, as illustrated below.

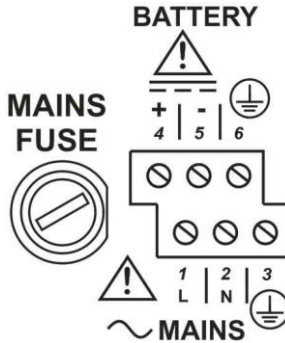

### Fascia mount

The mains fuse is located under the removable cover at the bottom of the unit, as illustrated below.

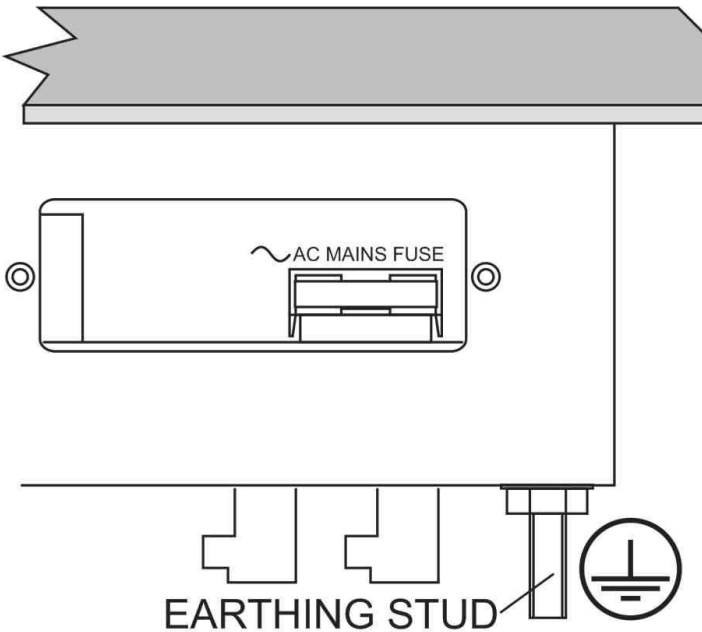

### **Important Information**

**The rear metal case of the fascia unit must be connected to earth via the earthing stud located on the rear of the unit, see drawing above, using wiring to meet local requirements.**

Before applying AC power (mains), make sure the supply is 115V AC.

Never operate the *Ultra Twin* with terminal access exposed.

An external switch or circuit breaker should be installed near to the *Ultra Twin* to allow the supply to be removed during installation and maintenance. In addition, the relay contacts should also have a means of isolating them from the *Ultra Twin*.

Interconnecting cables must be adequately insulated in accordance with local regulations. Strip back 30 mm of the outer insulation of the cable. Strip 5 mm of insulation from the end of each conductor. Twist all exposed strands of the conductor together. Insert the stripped conductor into the terminal block as far as it will go and tighten the terminal block screw. Ensure that all strands are firmly clamped in the terminal block and that there is no excess bare conductor showing, and no stray strands.

### **Important Information**

If the equipment is installed or used in a manner not specified in this manual, then the protection provided by the equipment may be impaired.

## **Preparation for Operation**

Before switching on, check the following:

- ✓ The *Ultra Twin* is mounted correctly and is in a 'safe' area.
- ✓ The power supply is correctly installed.
- ✓ The relays are connected correctly.

## Maintenance

There are no user serviceable parts inside your *Ultra Twin*, except the mains fuse. If you experience any problems with the unit, then please contact Pulsar Process Measurement for advice.

### Important Information

Please note that the on-board Lithium battery, mounted to the processor PCB, is not user serviceable.

To clean the equipment, wipe with a damp cloth. Do not use any solvents on the enclosure.

### Important Information

The unique DATEM software comes into operation as soon as power is applied and is designed to monitor a **moving level** or **target** with the **transducer** in a **fixed position**.

If, after any period of use, it should become necessary to move the transducer, for any reason, from its original operating position, switch off the *Ultra*, before proceeding, to prevent any undesirable updates to the DATEM trace. If after moving the transducer the reading is not as expected, please refer to **Chapter 6 Troubleshooting**.

### Operating the Controls

#### Display

On the **wall mount** model, there are two identical displays, by default, the **top display** will provide information on the current mode of operation, and status of the remote communication for **point 1 (transducer 1)**, while the **bottom display** provides the same information for **point 2 (transducer 2)**. In the case of the **fascia** model, while in the RUN mode, the single display will provide information for **point 1 (transducer 1)** on the **main display** line and the **auxiliary display** provides the same information for **point 2 (transducer 2)**.

When in **Program Mode** the display of the **fascia** mount model can be “toggled” by pressing  to change from point 1 to point 2 to access parameters on each point.

While in the Run Mode the display will show the current level reading and its units of measure, along with status messages with regards to the Transducer, Echo reception and Fail Safe Mode. Additionally, they can be programmed independently to provide status messages on alarms, pumps etc.

When in the Program mode the display is used to read information on the Menu System, Point of Measurement, Parameter Number and parameter details and values, which can be entered.

During Test Mode, the display is used to monitor the simulated level. A bar graph is also provided which will provide a visual reading of the level, in percentage of span.



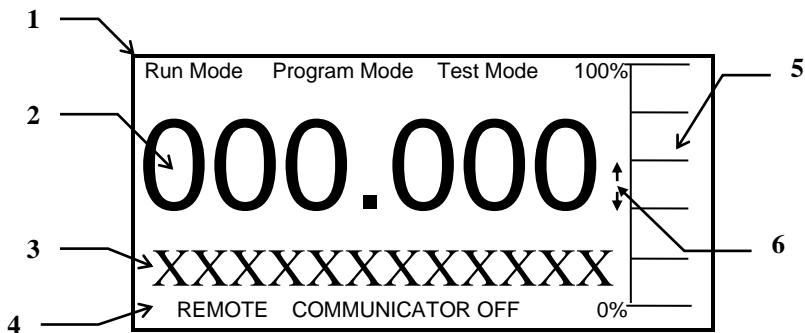

- 1) Mode status enunciator displays the current mode of operation.
- 2) Main 6-digit display:
  - Run Mode**, current measurement displayed, dependent on mode and measurement unit's chosen, and value of Hot Key function selected.
  - Program Mode**, displays parameter number and values entered for parameters.
  - Test Mode**, displays simulated level.
- 3) Auxiliary Display, scrolling twelve-digit display.
  - Run Mode**, displays measurement units (P104), status messages on signal and transducer, detail of Hot Key function selected. It can be also programmed to provide notification messages on alarms and pumps etc. for full details please refer to **Display Parameters** in the relevant parameter listing.
  - Program Mode**, displays Menu and Sub Menu headings, parameter details and options.
- 4) Communicator status enunciator displays the current status of, Remote Communicator (rack and panel versions only) or remote PC connection.
- 5) Bargraph, display, gives visual indication of measurement in % of span.
- 6) Level indicators
  - Run Mode**, indicates in which direction the level is moving.
  - Program Mode**, indicates at which level of the menu system you are at.

There are two main operating modes for your *Ultra Twin*, **Run Mode** and **Program Mode**. There is also a **Test Mode**, used for checking the set-up. All modes are now described.

### **Run Mode**

This mode is used once the *Ultra Twin* has been set up in program mode. It is also the default mode that the unit reverts to when it resumes operation after a power failure.

When the *Ultra Twin* is switched on for the first time, it will display, in feet, the distance from the transducer face to the target. All relays by default are switched off.

After programming is complete, any relays that are set will operate when the level reaches the relevant setpoint, on the point of measurement it has been allocated to, and the LED's will change colour (unless specifically switched off).

### **Program Mode**

This mode is used to set up the *Ultra Twin* or change information already set. This is achieved by using the built-in keypad or, alternatively the unit can be set up with a PC via the RS 232 Serial Interface.

Entering a value for each of the parameters that are relevant to your application provides all the programming information.

## How to Access Program Mode

To enter **program mode**, you simply enter the passcode, via the keypad, followed by the ENTER key. The **default passcode** is **1997**, so you would press the following:









### Note

There is a time-out period of 15 minutes when in **program mode**, after which time **run mode** will be resumed if you do not press any keys.

Once you have entered the **program mode** the *Ultra Twin* will automatically access point 1 menu system, and the top display will show “**Program Mode**” in the Mode Status Line and “**Quick Setup**” in the Auxiliary Display Line, in the case of the wall mount model, the bottom display, point 2, will be blank. To change from one point to the other point’s menu system press the  hot key, whilst in any Main Menu heading, e.g. Quick Setup, Application etc. and you will toggle between the two points and their relevant menu systems.





## Hot Keys

There are five hot keys on the keypad, which can be used to quickly access common parameters for viewing only, while in Run Mode. Pressing the hot key once will display the first parameter, then repeated pressing will display the others, then the *Ultra Twin* reverts to Run Mode. In program mode, they have different functions, the functions are shown below.

Hot Key	Run Mode	Program Mode
	When application is Flow, view non-resettable totaliser(s). View and reset the resettable totaliser(s). When application is Pump, view information on total pump running hours, and individual pump running hours.	Not used with <i>Ultra Twin</i> .
	Displays echo confidence, echo strength, H.A.L.L., average noise, peak noise or temperature.	Not used with <i>Ultra Twin</i> .
	When application is Pump, view total number of pump starts and individual pump starts.	Reset parameter to default setting.
	Instantaneous mA output.	Not used with <i>Ultra Twin</i> .
	Dependant on application displays Distance, Level, Space, Head, Flow, Volume or rate of change of level.	Toggle between Point 1 & 2 Main Menu System. When programming relays toggle relay setpoints between <i>Ultra Twin</i> 's units of measure and % of span.
	Not used with <i>Ultra Twin</i> .	Takes you to the last parameter edited, when you first enter program mode.
	Gives details of unit type, software revision and serial number.	Enter decimal point

## Menu Keys

The menu keys have the following functions:

Menu Key	Function
 	1) Arrow keys for moving left and right around the menu system. 2) Used in test mode to simulate the level moving up and down.
	1) Used to confirm each action (for example select a menu option) or when entering a parameter number or value. 2) Used to confirm questions asked by your <i>Ultra Twin</i> such as before restoring factory defaults.
	Used to navigate up a level in the menu system, and back to run mode. Used to cancel a value entered in error.

## Numeric Keys

These keys are used for entering numerical information during programming.



There are two means of editing parameters, directly or using the menu system. Each is now described.

### Using the Menu System

The menu system has been designed to make the changing of parameters very simple. There are two levels of menu: **Main Menu** and **Sub Menu**.

### Main Menu

The **main** or **top** menu is common to both points of measurement and when you first access the **program mode** your *Ultra Twin* will display the menu system for **point 1**. To **change** from one point to **point 2** menu system, press the  **hot key**, whilst in any **Main Menu** heading, e.g. Quick Setup, Application etc. and you will toggle between the two points and their relevant menu systems.

### Sub Menu

Any **sub-menu** and the **parameters** contained in it relating to Point 1 (Transducer 1) is pre-fixed P1, sub-menus and parameters relating to Point 2 (Transducer 2) are pre-fixed P2. Menus and parameters which are common to both Points (both transducers) are pre-fixed P\* e.g. P\*104 Measurement Units.

On the display, there is a line of text that displays the menu system. Pressing the arrow keys scrolls the display between the top-level menu items, (as shown below, starting at Quick Setup).

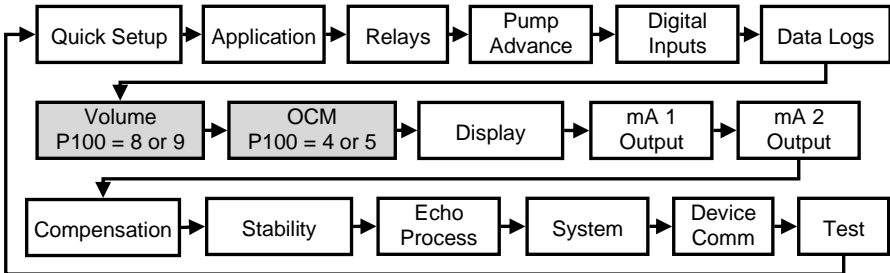

As you press the cursor keys to scroll left and right between these, you can press ENTER at any time, to select the desired menu heading, and take you to the sub-menu.

Each of these options, along with their sub-menus are described later in this manual. When you move down into the sub-menu, you can scroll round using the arrow keys press ENTER to go to the required section of parameters.

Once you have reached the relevant section, scroll through the parameters, and enter the necessary information. To enter the information, use the numeric keys and then press ENTER, you will then see the message “**Saved!**” If you press CANCEL, then the change you made will not be saved, and the message “**Unchanged!!**” will be displayed.

When you have finished, press CANCEL to go back to the previous level. When you have reached the top level, then the *Ultra Twin* will ask for confirmation before allowing you to go back into run mode. This is done by pressing ENTER at the display prompt.

#### **Note**

You can tell which part of the menu system you are in, as the up/down level indicators, (arrows) next to the bar graph will indicate as follows:

- **Top level menu: Down arrow on**, to indicate you can move down.
- **Sub-menu: Up and Down arrows on**, to indicate you can move up to the top level, and down to parameter level.
- **Parameter Level: Up arrow on**, to indicate you can move up to sub-menu level.
- **Parameter Editing: No arrows on**.

#### ***Directly Editing Parameters***

If you already know the number of the parameter, that you wish to look at or edit, simply access the relevant point of measurement and type the number in at any time while you are in the menu system. So, if you are in either the menu or sub-menu level by pressing a numeric key, you can enter the parameter number directly and jump straight there. You cannot type a parameter number whilst at parameter level, only at one of the two menu levels.

When you are at a parameter, the text line rotates automatically displaying the parameter name, number, the applicable units and the maximum and minimum figure you can enter. The top line shows the value you are setting.

Once you have accessed a parameter, you can either just look at it, or change it.

Once a parameter has been changed, press ENTER and you will see the message “**Saved!**”. If you press CANCEL, then the change you made will not be saved, and the message “**Unchanged!**” will be displayed.



**TIP**

You can jump straight to the last parameter you edited, by pressing ‘+/-’ when you first enter program mode.

## Test Mode

Test mode is used to simulate the application and confirm that all parameters and relay setpoints have been entered as expected. During simulation, there is a choice of whether the relays will change state (hard simulation) or not (soft simulation), but the LED’s will always change colour as programmed, and the mA output will change in accordance to the chosen mode of operation. If you wish to test the logic of the system that the **relays are connected** to then select **hard simulation**, but if you **don’t wish to change the relay state**, then select a **soft simulation**.

There are two simulation modes, automatic and manual. Automatic simulation will move the level up and down between empty level or the pre-determined **Start Level (P\*983)** and Pump/Control relay switch points, if you wish to change the direction of the level movement e.g. to go beyond relay setpoints, this can be done by using the arrow keys. In manual simulation, using the arrow keys will allow you to move the level up and down as required.

To enter simulation, first go to **program mode**. Using the menu system, select menu item ‘**Test**’, then sub-menu item **P1** or **P2‘Simulation’**. Simply change the value of the parameter **P1-980, P2-980** to one of the following:

- 1= Manual soft simulation
- 2= Automatic soft simulation
- 3= Manual hard simulation
- 4= Automatic hard simulation



To return to program mode, press CANCEL and test mode will end.

When in **manual** simulation, by default test mode will move the level by 0.328 feet steps. Altering the **increment (P\*981)** will change this value.

In **automatic** mode, the rate at which the level moves up and down is set by the **increment (P\*981)** in feet, the **rate (P\*982)** in minutes, which can be changed to make the level move up and down faster. E.g. if **increment (P\*981)** is set for 0.1m and **rate (P\*982)** is set to 1 min then the level will increase or decrease at a rate of 0.1m/min. To make the simulated level move slower, decrease the value in **increment (P\*981)** or increase the value in **rate (P982)**. To make the simulated level move faster, increase the value in **increment (P981)** or decrease the value in **rate (P\*982)**.

## Using the RS232 Serial Interface

The RS232 serial interface is used to communicate between the *Ultra Twin* and a PC using the optional Ultra PC and other associated Pulsar software packages, to obtain information such as data logging and view echo traces upload, download and save parameter files. In addition, it can also be used to control or obtain information using a standard PC or other computer base equipment. To do so, the settings for control are as follows: **baud rate 19,200, 8 data bits, no parity, 1 stop bits**.

The device should be connected via the serial port, as shown in **Chapter 2 Installation**.

To use the device remotely, you need to **log on** to start, and **log off** when finished. When **logged on**, *Ultra Twin* will show '**Remote ON**' on the display, and "**Communicator OFF**" when **logged off**.

*All commands should be followed by a carriage return.*

The unit will respond either OK (or a value) if the command is accepted, or NO if it is not.

To log on, send the command

/ACCESS:pppp where pppp is the passcode (P922).

To log off, send the command

/ACCESS:OFF

To read a parameter value, send the command

/Pxxxx where xxxx is the parameter you wish to read, and the *Ultra Twin* will respond with the parameter value.

To set a parameter, send the command

/Pxxx:yy where xxx is the parameter number, and yy is the value you wish to set it to.

Other commands you can use are:

/DISTANCE\* (shows current distance)

/LEVEL\* (shows current level)

/SPACE\* (shows current space)

/HEAD\* (shows current OCM head)

/FLOW\* (shows current OCM flow)

/TEMPERATURE\* (shows current temperature)

/CURRENTOUT\*\* (show the mA output value)

/TOTALISER\* (show 10 day totaliser logs)

\* add 1 for channel (point)1 or 2 for channel (point) 2.

\*\* add 1 for mA Output 1 or 2 for mA Output 2

Please consult Pulsar Process Measurement or contact your local Pulsar representative for further details and a full list of available commands.

## Parameter Defaults

### Factory Defaults

#### Factory Defaults

When first installing the *Ultra Twin*, or subsequently moving or using the unit on a new application, before proceeding to program the unit for its intended application it is recommended that you ensure that all parameters are at their default values by completing a **Factory Defaults P\*930**, as described in the relevant unit type **parameter guide**.

When you first switch the *Ultra Twin* on, it will be reading the **distance** from the face of the transducer to the surface. It will be indicating in **feet**, as shown on the display. All relays are set OFF.

The **date** (P\*931) and **time** (P\*932) in the *Ultra Twin* were set at the factory, but may need checking, and amending if, for example the application is in a time zone other than GMT, see relevant unit **Parameter listing** for full details.

#### TIP



In some applications, it is simplest to empty the vessel, take a reading from the *Ultra Twin* for distance and then setup the empty level to this figure.

Once you are satisfied with the installation, and the *Ultra Twin* is reading what you would expect in terms of distance from the face of the transducer to the material level, then you can proceed with programming, for the intended application. It is sensible to program all the required parameters at the same time. The system will be then set-up.

*Note that the span is automatically calculated from the empty level, so the empty level should be entered first.*

This quick set-up guide shows you how to get up and running in a few minutes in just four easy steps after installing your *Ultra Twin*.

### Enter Program Mode

First you need to go from run mode into program mode. Assuming the passcode is the default 1997, then you should enter this.



### Choose Quick Setup

Now you need to go into the quick setup. You will see on the menu the words 'Quick Setup', which is the first item on the menu system. By default, the *Ultra Twin* will always access **point 1** menu system to **change** to **point 2** menu press the  **hot key**. Try pressing the two arrow keys to see some more menu options, but return to Quick Setup, and press



This takes you to the common applications parameter (P200).



This takes you to the common applications parameters, and you will see some options appearing on the display.

#### **Note**

If you have already setup a common application, then there will be a number shown other than 0, and you will see messages showing what the current setup is. If you want to reset this and start again, press 0 (which will reset all the quick setup parameters), otherwise pressing ENTER will allow you to edit the parameters that have been set.

There are three categories of application, which are all described later in this chapter. They are **level/volume**, **pump** or **flow** all with the choice of control functions and alarms.

## **Level or Volume**

If you want to set-up a **level** or **volume** application, as described in the following examples, then choose **1** for **Level/Vol**. You will then be given a choice of **1 = Level** or **2 = Volume**.

### **Choose Your Application**

If you want to set-up a basic **level monitoring** application, as described in the following **example 1**, then choose **1** for **Level/Vol**. and then **1** for **level**.

If you want to set-up a **level monitoring** application with **control relays**, as described in the following **example 2**, then choose **1** for **Level/Vol**. followed by **1** for **level** and choose either **control down** (press 1) or **control up** (press 2).

If you want to set-up a **volume** application, as described in the following **example 3**, then choose **1** for **Level/Vol**. followed by **2** for **volume**, you then need to decide if any control function is required and choose the appropriate option **no control** (press 0), **control down** (press 1) or **control up** (press 2).

Once you have chosen your application you will be asked a series of questions which are answered by choosing the appropriate option as detailed in the flow chart below. Once all of the questions have been answered you will be prompted to provide further information, as detailed in the tables below, in order to complete the programming of the unit.

# Quick Setup Menu

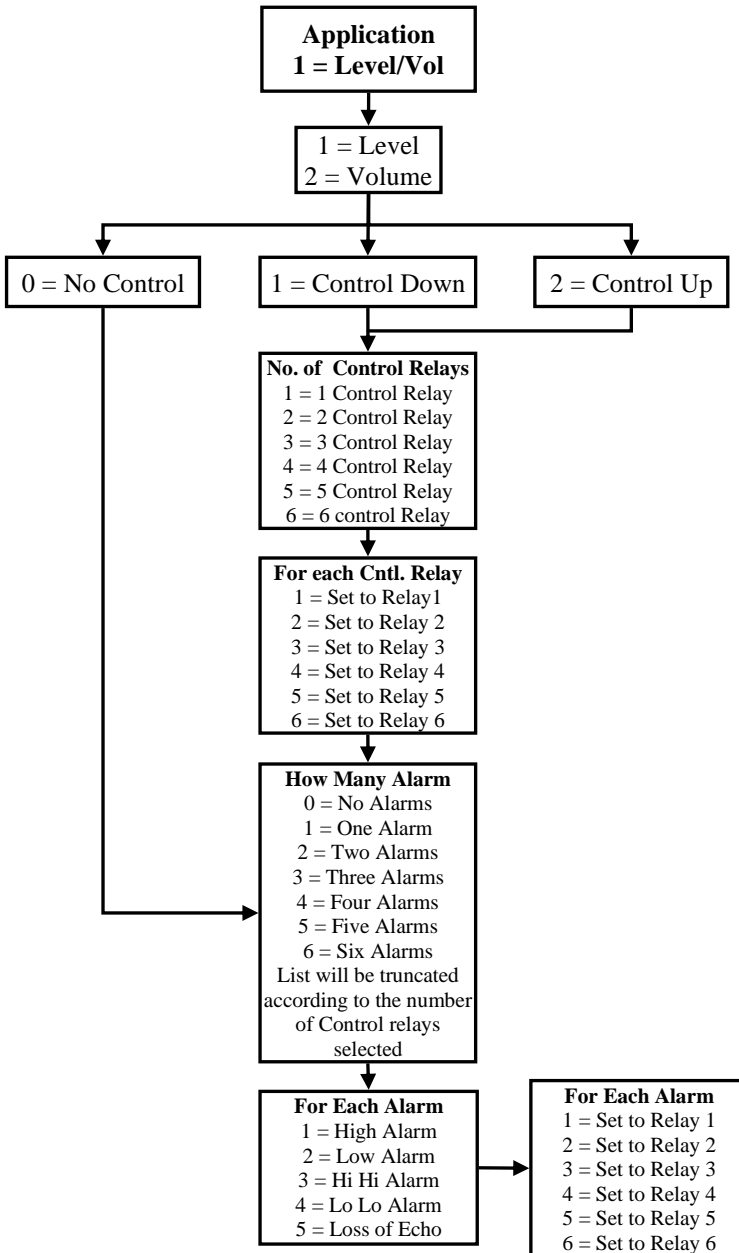

Wait .....

Parameter	Default	Description
P101 Transducer	2 = dB6	Type of transducer being used.
P102 Material	1 = liquid	Material in the vessel, either liquid or solid. If the solid lays flat then it can be entered as liquid.
P104 Measurement Units	4 = feet	Select units to be used for programming measurement information.
P105 Empty Level	19.685 feet	Distance from the face of the transducer to the material at the bottom of the vessel.
P106 Span	18.701 feet	Distance from the empty level (0% full) to span (100% full).

**If you have selected a Volume Application, you will now be prompted to enter details required for the calculation of volume**

Parameter	Default	Description
P600 Vessel Shape	0=Cyl. Flat Base	Shape of vessel being monitored.
P601-P603 Vessel Dimensions	dependant on vessel shape selected.	Enter Vessel dimensions as required
P605 Volume units	7 = Cubic ft	Selects volume units required.
P607 Max Volume	Read Only	Displays the calculated Volume in P605 units.

**For More Options Hit Enter**

<b>Parameter</b>	<b>Default</b>	<b>Description</b>
P213 / P214 Relay 1 ON/OFF setpoints	Factory preset as a % to appropriate level according to the span already entered. See tables below	Either Alarm or Level control. Depends on application.
P223 / P224 Relay 2 ON/OFF setpoints	Factory preset as a % to appropriate level according to the span already entered. See tables below	Either Alarm or Level control. Depends on application.
P233 / P234 Relay 3 ON/OFF setpoints	Factory preset as a % to appropriate level according to the span already entered. See tables below	Either Alarm or Level control. Depends on application.
P243 / P244 Relay 4 ON/OFF setpoints	Factory preset as a % to appropriate level according to the span already entered. See tables below	Either Alarm or Level control. Depends on application.
P253 / P254 Relay 5 ON/OFF setpoints	Factory preset as a % to appropriate level according to the span already entered. See tables below	Either Alarm or Level control. Depends on application.
P263 / P264 Relay 6 ON/OFF setpoints	Factory preset as a % to appropriate level according to the span already entered. See tables below	Either Alarm or Level control. Depends on application.
P830 mA Out Range	2= 4 to 20 mA	Determines the mA output range. 0 = Off, 1 = 0 to 20mA, <b>2 = 4 to 20mA</b> , 3 = 20 to 0mA, 4 = 20 to 4mA.
P870 Fill Damping	32.80 ft/min	Rate of maximum fill rate (set above the actual fill rate of the vessel).
P871 Empty Damping	32.80 ft/min	Rate of maximum empty rate (set above the actual empty rate of the vessel).



The default values used for determining the **relay setpoints**, when setting **Alarm** and **Control** relays, via the **Quick Setup** menu are entered as a % of span and are as follows.

<b>Application</b>	<b>Number of Cntl Relays</b>	<b>Cntl Relay Number</b>	<b>On Setpoint</b>	<b>Off Setpoint</b>
Cntl. Down	One	Control 1	80%	20%
Cntl. Down	Two	Control 1	80%	20%
		Control 2	70%	20%
Cntl. Down	Three	Control 1	80%	20%
		Control 2	70%	20%
		Control 3	60%	20%
Cntl. Down	Four	Control 1	80%	20%
		Control 2	70%	20%
		Control 3	60%	20%
		Control 4	50%	20%
Cntl. Down	Five	Control 1	80%	20%
		Control 2	70%	20%
		Control 3	60%	20%
		Control 4	50%	20%
		Control 5	40%	20%
Cntl. Down	Six	Control 1	80%	20%
		Control 2	70%	20%
		Control 3	60%	20%
		Control 4	50%	20%
		Control 5	40%	20%
		Control 6	30%	20%

<b>Application</b>	<b>Number of Cntl Relays</b>	<b>Cntl Relay Number</b>	<b>On Setpoint</b>	<b>Off Setpoint</b>
Cntl. Up	One	Control 1	20%	80%
Cntl. Up	Two	Control 1	20%	80%
		Control 2	30%	80%
Cntl. Up	Three	Control 1	20%	80%
		Control 2	30%	80%
		Control 3	40%	80%
Cntl. Up	Four	Control 1	20%	80%
		Control 2	30%	80%
		Control 3	40%	80%
		Control 4	50%	80%
Cntl. Up	Five	Control 1	20%	80%
		Control 2	30%	80%
		Control 3	40%	80%
		Control 4	50%	80%
		Control 5	60%	80%
Cntl. Up	Six	Control 1	20%	80%
		Control 2	30%	80%
		Control 3	40%	80%
		Control 4	50%	80%
		Control 5	60%	80%
		Control 6	70%	80%

<b>Relay Function</b>	<b>Relay I.D.</b>	<b>On Setpoint</b>	<b>Off Setpoint</b>
Alarm	HiHi	90%	85%
Alarm	High	85%	80%
Alarm	Low	10%	15%
Alarm	LoLo	5%	10%

**Note**

When using the Quick Setup Menu relays will be allocated to the point of measurement you are currently setting up and the availability of relays will depend on the number of relays used when setting up the previous point of measurement via the Quick Setup Menu for that point.

## **Example 1 Level Monitoring with Alarms**

A vessel, containing a liquid that has a variation in level that is to be monitored, with a high level alarm set on Relay 1, and low level alarm set on Relay 2.

**The application is to be assigned to Point (transducer) 1.**

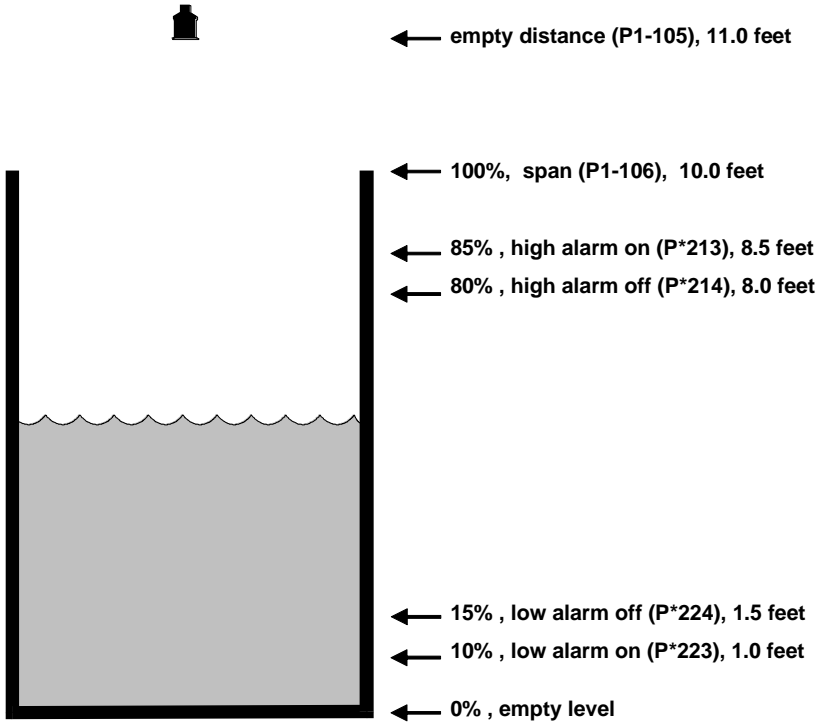

In this example, when the level rises to 8.5 feet, Relay 1 will come on until the level drops to 8.0 feet when it will turn off. If the level drops to 1.0 feet, then Relay 2 will come on until it rises to 1.5 feet when it will turn off.

The display will show the level in the tank.

The mA output 1 will be representative of level where 4mA = empty level (0%) and 20mA = 10.0 feet (100%).

To program the *Ultra Twin* for **Example 1 Level Monitoring with alarms** by using the **Quick Setup** menu proceed as follows.

If required access the **Program Mode**

Key in the **passcode** 1997 and press **ENTER**

At the **Quick Setup** menu press **ENTER** and as prompted, by the questions, select the relevant option and **ENTER**.

Question	Option
Application	1= Level/Vol.
Level/Volume	1 = Level
Control	0 = No Control
No. of Alarms	2 = 2 Alarms
Type Alarm 1	1 = High
Alarm No 1	1 = Set Relay 1
Type Alarm 2	2 = Low
Alarm No 2	2 = Set Relay 2
Xducer (P1-101)	2 = dB6
Material (P1-102)	1 = Liquid
Measnt Units (P*104)	4 = feet
Empty Level (P1-105)	11 (feet)
Span (P1-106)	10.0 (feet)

Programming is now complete and the unit can be returned to the run mode, press **CANCEL** until **Run Mode?** Is displayed on the LCD press **ENTER**, and the *Ultra Twin* will return to the **Run Mode**.

#### Note

If relay setpoints do not meet the exact requirements of the application, they can be modified to suit by pressing **ENTER** when, “For More Options Hit Enter”, is displayed and entering new values to relay setpoints as required. Alternatively, the relevant relay setpoint can be accessed either by the main menu system or directly via parameter number and changed as necessary.

## Example 2 Level Monitoring and Control (up or down)

A vessel, containing a liquid that has a variation in level that is to be monitored, and when the level reaches a specific point, the vessel is pumped down, with the fluid being transferred to another process. The pump will be assigned to Relay 1 a High Alarm to Relay 2 and Low Alarm to Relay 5.

The application is to be assigned to Point (transducer) 2.

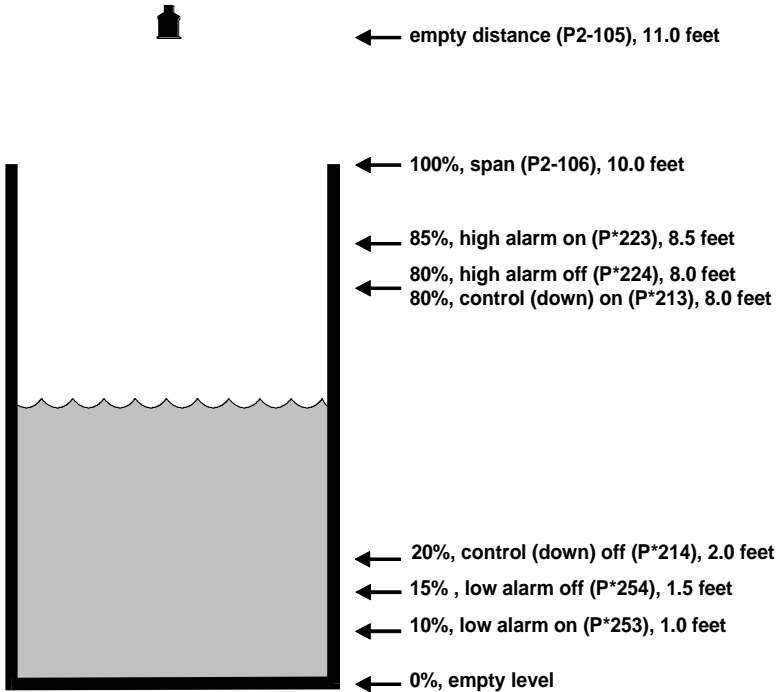

In this example, there is a pump (Relay 1), which will come on if the level rises to 8.0 feet and go off when the level drops to 2.0 feet. (**control down**). If the level rises to 8.5 feet, then the high-level alarm (Relay 2) will come on until the level drops to 8.0 feet. If the level falls to 1.0 feet, then the low-level alarm (Relay 5) will come on until the level rises to 1.5 feet.

Alternatively, if it is a **control up** application, then the on and off points for the control relay are reversed, so the pump comes on when the level is at 2.0 feet and goes off when it rises to 8.0 feet.

The display will show the level in the tank and mA output 2 will be representative of level where 4mA = empty level (0%) and 20mA = 10.0 feet (100%).

To program the *Ultra Twin* for **Example 2 Level Monitoring and Control** by using the **Quick Setup** menu proceed as follows.

If required access the **Program Mode**

Key in the **passcode** 1997 and press **ENTER**

At the **Quick Setup** menu press the  hot key and toggle to Point 2 display and press **ENTER** and then as prompted, by the questions, select the relevant option and **ENTER**.

Question	Option
Application	1 = Level/Vol.
Level/Volume	1 = Level
Control	1 = Control Down
No. of Controls	1 = 1 Relay
Control No. 1	1 = Set Relay 1
No. of Alarms	2 = 2 Alarms
Type Alarm 1	1 = High
Alarm No. 1	2 = Set Relay 2
Type Alarm 2	2 = Low
Alarm No. 2	5 = Set Relay 5
Xducer (P2-101)	2 = dB6
Material (P2-102)	1 = Liquid
Measnt Units (P*104)	4 = feet
Empty Level (P2-105)	11.0 (feet)
Span (P2-106)	10.0 (feet)

Programming is now complete, and the unit can be returned to the run mode, press **CANCEL** until **Run Mode?** Is displayed on the LCD press **ENTER**, and the *Ultra Twin* will return to the **Run Mode**.

**Note**

If relay setpoints do not meet the exact requirements of the application, they can be modified to suit by pressing **ENTER** when, “For More Options Hit Enter”, is displayed and entering new values to relay setpoints as required. Alternatively, the relevant relay setpoint can be accessed either by the main menu system or directly via parameter number and changed as necessary.

### **Example 3 Volume Application**

A cylindrical tank with a diameter of 7 feet and a flat base that is typically used to temporarily hold liquid, and you wish to know the volume of liquid. You also require a high (Relay 4) and a low alarm (Relay 5) and when the level reaches a specific point, the vessel is pumped down (Relay 1), with the fluid being transferred to another process.

The application is to be assigned to Point (transducer) 1.

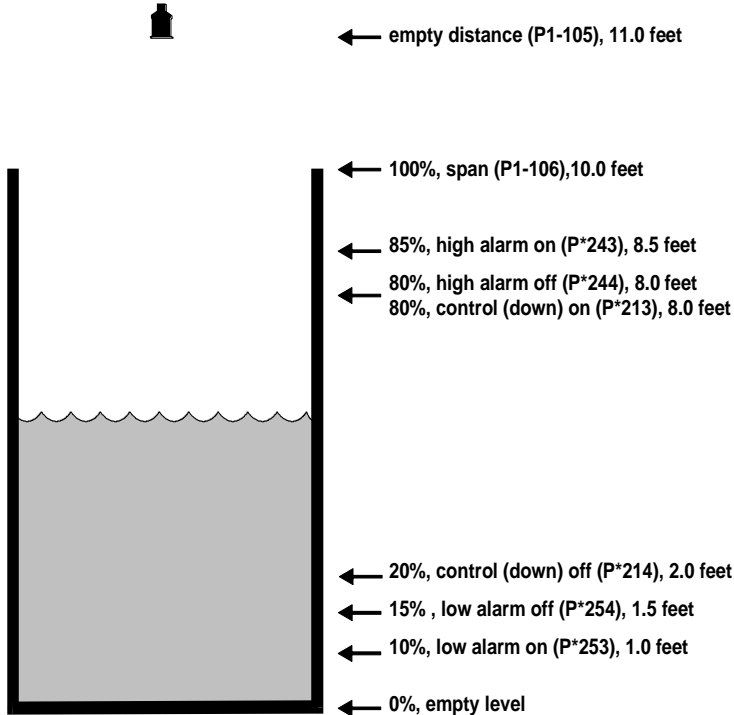

In this example, there is a **control down** relay (Relay 1), which will come on if the level rises to 8.0 feet and go off when the level drops to 2.0 feet. (**control down**). If the level rises to 8.5 feet, then the high-level alarm (Relay 4) will come on until the level drops to 8.0 feet. If the level falls to 1.0 feet, then the low-level alarm (Relay 5) will come on until the level rises to 1.5 feet.

The display will show the volume of fluid in the tank and the mA output 1 will be representative of Volume where 4mA = empty (0%) and 20mA = Max Volume (100%).

To program the *Ultra Twin* for **Example 3 Volume Application with Control** by using the **Quick Setup** menu proceed as follows.

If required access the **Program Mode**

Key in the **passcode** 1997 and press **ENTER**

At the **Quick Setup** menu press **ENTER** and as prompted, by the questions, select the relevant option and **ENTER**.

Question	Option
Application	1= Level/Vol.
Level/Volume	2= Volume
Control	1= Control Down
No. of Controls	1 = 1 Relay
Control No. 1	1 = Set Relay 1
No. of Alarms	2 = 2 Alarms
Type Alarm 1	1 = High
Alarm No. 1	4 = Set Relay 4
Type Alarm 2	2 = Low
Alarm No. 2	5 = Set Relay 5
Xducer (P1-101)	2 = dB6
Material (P1-102)	1= Liquid
Measnt Units (P*104)	4 = feet
Empty Level (P1-105)	11.0 (feet)
Span (P106)	10.0 (feet)
Vessel Shape (P1-600)	0 = Cylindrical Flat Base
Vessel Dimensions	Enter Vessel Dimensions as requested (depends on vessel shape chosen)
Volume Units	Select as required
Max. Volume (Read Only)	Displays the Max Volume as calculated by the <i>Ultra Twin</i>

Programming is now complete and the unit can be returned to the run mode, press **CANCEL** until **Run Mode?** Is displayed on the LCD press **ENTER**, and the *Ultra Twin* will return to the **Run Mode**.

**Note**

If relay setpoints do not meet the exact requirements of the application, they can be modified to suit by pressing **ENTER** when, “For More Options Hit Enter”, is displayed and entering new values to relay setpoints as required. Alternatively, the relevant relay setpoint can be accessed either by the main menu system or directly via parameter number and changed as necessary.



## **Example 4 : Differential Control**

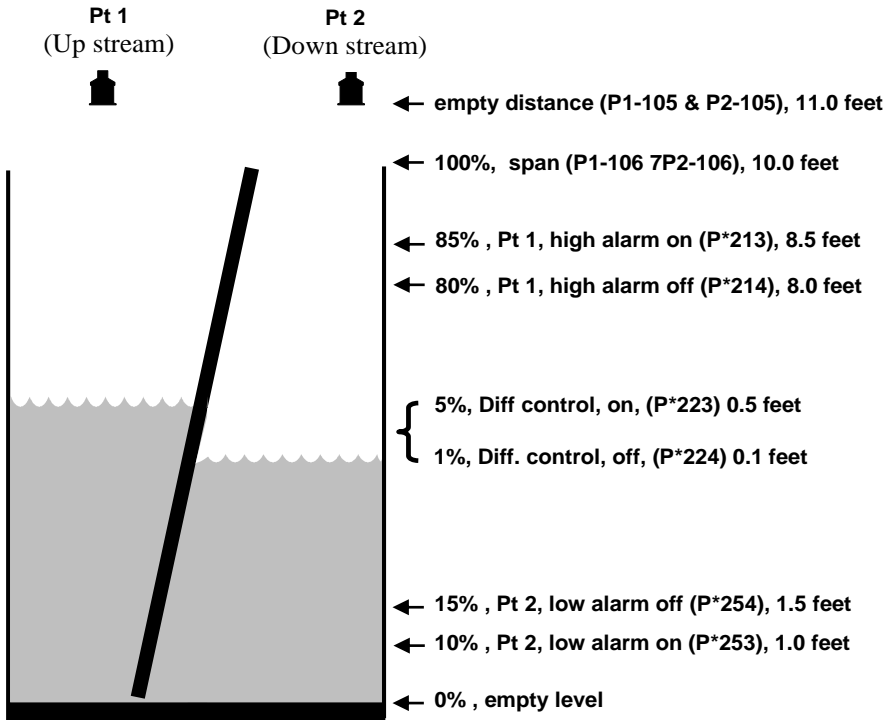

### **Note**

In this example, the transducers are mounted at the same height. If the transducers are mounted at different heights, ensure that the empty levels are correct such that there is no differential present when the level is zero on both sides.

In this example the Ultra Twin is being used to control a rake on a screen, which is filtering out solids in the inlet flow to a wastewater treatment plant.

This will be achieved by setting up a **level** application on both **Point 1** and **2** and **assigning** the **relays** to the **relevant point(s)** to obtain the desired control.

A **high alarm** has been assigned to Point 1 (**Transducer 1**), on the **upstream** side and a **low alarm**, to Point 2 (**Transducer 2**) on the **downstream** side. The Diff. Control, to operate the rake is on Relay 1, high alarm, on Transducer 1 (upstream), is on Relay 2 and, low alarm, on Transducer 2 (downstream) is on Relay 3.

This will operate as follows, when the level rises on the upstream side and/or the level on the downstream side falls, resulting in a differential of 0.5 feet, (anywhere within the working span), indicating that the screen is blocked, Relay 1 will come on and operate the rake. Once the level on the inflow has decreased and the differential level falls to 0.1 feet Relay 1 will switch off the rake.

Should the level on the upstream side rise, for any reason, to a level of 8.5 feet, Relay 2 will operate to give a high alarm, once the level has fallen back to 8.0 feet the alarm will go off. A falling level in the downstream side, for any reason, will operate Relay 3 at 1.0 feet giving an alarm for low level, once the level has risen again to a value of 1.5 feet Relay 3 will reset.

To program the *Ultra Twin* for **Example 4: Differential Control** by using the **Quick Setup** menu proceed as follows.

If required access the **Program Mode**

Key in the **passcode** 1997 and press **ENTER**

At the **Quick Setup** menu for **Point 1** press **ENTER** and as prompted by the questions, select the relevant option and **ENTER**.

Question	Option
Level/Vol, Pump or Flow	1 = Level/Vol.
Level or Volume	1 = Level
Control	1 = Control Down
No. of Controls	1 = 1 Control Relay
Control No. 1	1 = Set to Relay 1
No. of Alarms	1 = 1 Alarm
Type Alarm 1	1 = High Alarm
Alarm No.1	2 = Set to Relay 2
Xducer (P1-101)	2 = dB6
Material (P1-102)	1 = Liquid
Measnt Units (P*104)	4 = feet
Empty Level (P1-105)	11.0 (feet)
Span (P1-106)	10.0 (feet)

Press **CANCEL** to come out of the **Quick setup** menu for point 1 and press the  hotkey to switch to point 2.

At the **Quick Setup** menu for point 2 press **ENTER** and as prompted by the questions, select the relevant option and **ENTER**.

Question	Option
Level/Vol, Pump or Flow	1 = Level/Vol.
Level or Volume	1 = Level
Control	0 = No Control
No. of Alarms	1 = 1 Alarm
Type Alarm 1	2 = Low Alarm
Alarm No. 1	3 = Set to Relay 3
Xducer (P2-101)	2 = dB6
Material (P2-102)	1 = Liquid
Measnt Units (P*104)	4 = feet
Empty Level (P2-105)	11.0 (feet)
Span (P2-106)	10.0 (feet)

When prompted “**For more options hit ENTER**”, press **ENTER**. Use the **left** and **right** arrow keys and the **ENTER** key to access the following parameters and change their values to those shown below.

Parameter	Value
P*213, R1 Set 1	0.5 (feet)
P*214, R1 Set 2	0.1 (feet)

Press **ENTER** to save the new values.

Press **CANCEL** and when **Quick Setup** is displayed scroll across to the **Relays** menu. Press **ENTER** and press **ENTER** again when \* **Relay 1** is shown on the screen. Scroll across to **P\*216** and set the following. This will set up the differential control relay.

Parameter	Value
P*216, R1 Alloc.	5 = Diff.1-2

After pressing **ENTER** to save the parameter, press **CANCEL** until **Relays** is displayed on the screen.

On the wall mount model, to display the Differential on the main display line of the upper LCD, Point 1 Level on the auxiliary display of the upper LCD and Point 2 Level on the main display on the lower LCD, change the following parameters. Press the  hotkey to switch back to point 1. The upper LCD should now show **Relays**. Press the **Right** arrow key until **Display** is shown on the screen. Press **ENTER** and press **ENTER** again when **P1 Options** is displayed on the screen. Use the **left** and **right** arrow keys and **ENTER** key to change the following parameter and press **ENTER** to save the new value.

Parameter	Value
P1-805, Disp Source	5 = Diff.1-2

After pressing **ENTER** to save the parameter, press **CANCEL** to display **P1 Options** on the screen. Press the **Right** arrow key until **P1 Auxiliary** is displayed and press **ENTER**.

Use the **left** and **right** arrow keys and **ENTER** key to change the following parameter and press **ENTER** to save the new value.

Parameter	Value
P1-816, Aux Source	1 = Point 1

Programming is now complete and the unit can be returned to the run mode, press **CANCEL** until **Run Mode?** Is displayed on the LCD press **ENTER**, and the Ultra Twin will return to the **Run Mode**.

## **Pump**

If you want to set-up a **pump** application, as described in the following examples, then choose **2** for **pump**. You will then be given a choice of **1 = Level App.**, **2 = Pump Down** or **3 = Pump Up**.

### **Choose Your Application**

If you want to set-up a **pump down** (sump control) application, as described in the following **example 1** then choose **2** for **pump** followed by **2** for **pump down**.

If you want to set-up a **pump up** (reservoir control) application, as described in the following **example 2** then choose then choose **2** for **pump** followed by **3** for **pump up**.

Once you have chosen your application you will be asked a series of questions which are answered by choosing the appropriate option as detailed in the flow chart below. Once all the questions have been answered you will be prompted to provide further information, as detailed in the tables below, in order to complete the programming of the unit.

# Quick Setup Menu

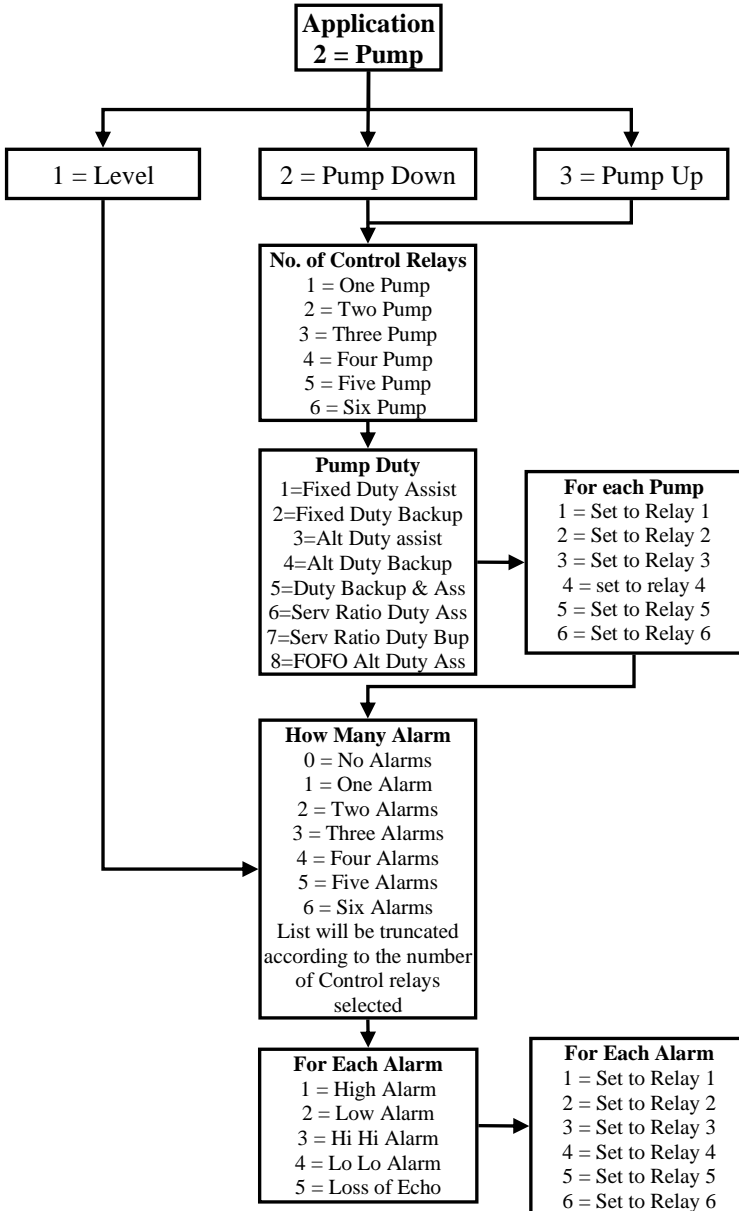

## Wait ....

<b>Parameter</b>	<b>Default</b>	<b>Description</b>
P101 Transducer	2 = dB6	Type of transducer being used.
P104 Measurement Units	4 = feet	Select units to be used for programming measurement information.
P105 Empty Level	19.685 feet	Distance from the face of the transducer to the material at the bottom of the vessel.
P106 Span	10.701 feet	Distance from the empty level (0% full) to span (100% full).

### For More Options Hit Enter

<b>Parameter</b>	<b>Default</b>	<b>Description</b>
P213 / P214 Relay 1 ON/OFF setpoints	Factory preset as a % to appropriate level according to the span already entered. See tables below	Either Alarm or Pump control. Depends on application.
P223 / P224 Relay 2 ON/OFF setpoints	Factory preset as a % to appropriate level according to the span already entered. See tables below	Either Alarm or Pump control. Depends on application.
P233 / P234 Relay 3 ON/OFF setpoints	Factory preset as a % to appropriate level according to the span already entered. See tables below	Either Alarm or Pump control. Depends on application.
P243 / P244 Relay 4 ON/OFF setpoints	Factory preset as a % to appropriate level according to the span already entered. See tables below	Either Alarm or Pump control. Depends on application.
P253 / P254 Relay 5 ON/OFF setpoints	Factory preset as a % to appropriate level according to the span already entered. See tables below	Either Alarm or Pump control. Depends on application.

Parameter	Default	Description
P263 / P264 Relay 6 ON/OFF setpoints	Factory preset as a % to appropriate level according to the span already entered. See tables below	Either Alarm or Pump control. Depends on application.
P830 mA Out Range	2= 4 to 20 mA	Determines the mA output range. 0 = Off, 1 = 0 to 20mA, <b>2 = 4 to 20mA</b> , 3 = 20 to 0mA, 4 = 20 to 4mA.
P870 Fill Damping	32.8084 feet/min	Rate of maximum fill rate (set above the actual fill rate of the vessel).
P871 Empty Damping	32.8084 feet/min	Rate of maximum empty rate (set above the actual empty rate of the vessel).

The default values used for determining the **relay setpoints**, when setting **Alarm** and **Pump** relays, via the **Quick Setup** menu are entered as a % of span and are as follows.

Application	Number of Pumps	Pump Number	On Setpoint	Off Setpoint
Pump Down	One	Pump 1	50%	20%
Pump Down	Two	Pump 1 Pump 2	50% 70%	20% 20%
Pump Down	Three	Pump 1 Pump 2 Pump 3	50% 60% 70%	20% 20% 20%
Pump Down	Four	Pump 1 Pump 2 Pump 3 Pump 4	40% 50% 60% 70%	20% 20% 20% 20%
Pump Down	Five	Pump 1 Pump 2 Pump 3 Pump 4 Pump 5	40% 50% 60% 70% 75%	20% 20% 20% 20% 20%
Pump Down	Six	Pump 1 Pump 2 Pump 3 Pump 4 Pump 5 Pump 6	40% 50% 60% 70% 75% 80%	20% 20% 20% 20% 20% 20%



<b>Application</b>	<b>Number of Pumps</b>	<b>Pump Number</b>	<b>On Setpoint</b>	<b>Off Setpoint</b>
Pump Up	One	Pump 1	50%	80%
Pump Up	Two	Pump 1	50%	80%
		Pump 2	30%	80%
Pump Up	Three	Pump 1	50%	80%
		Pump 2	40%	80%
		Pump 3	30%	80%
Pump Up	Four	Pump 1	60%	80%
		Pump 2	50%	80%
		Pump 3	40%	80%
		Pump 4	30%	80%
Pump Up	Five	Pump 1	60%	80%
		Pump 2	50%	80%
		Pump 3	40%	80%
		Pump 4	30%	80%
		Pump 5	25%	80%
Pump Up	Six	Pump 1	60%	80%
		Pump 2	50%	80%
		Pump 3	40%	80%
		Pump 4	30%	80%
		Pump 5	25%	80%
		Pump 6	20%	80%

<b>Relay Function</b>	<b>Relay I.D.</b>	<b>On Setpoint</b>	<b>Off Setpoint</b>
Alarm	HiHi	90%	85%
Alarm	High	85%	80%
Alarm	Low	10%	15%
Alarm	LoLo	5%	10%

**Note**

When using the Quick Setup Menu relays will be allocated to the point of measurement you are currently setting up and the availability of relays will depend on the number of relays used when setting up the previous point of measurement via the Quick Setup Menu for that point.

### **Example 1 Sump Control (pump down)**

A sump is typically used to temporarily hold water or effluent, and when the level reaches a specific point, the sump is pumped down, with the fluid being transferred to another process.

**The application is to be assigned to Point (transducer) 1.**

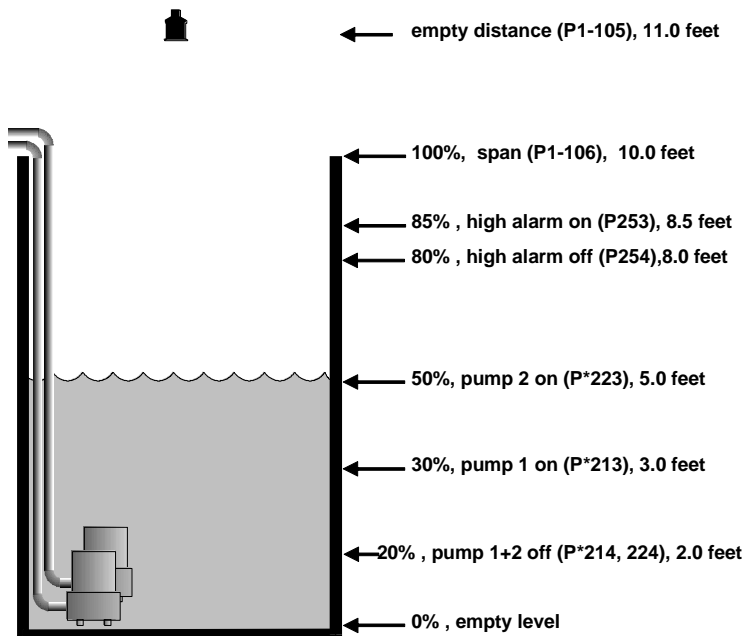

In this example, there are two pumps, which will be set to **alternate duty assist**, so they come on alternately. Pump 1 is to be set to Relay 1, Pump 2 to Relay 2, and the high-level alarm to Relay 5.

This will operate as follows. During normal operation, **pump 1** will come on at 3.0 feet, and pump down to 2.0 feet. The setpoints are then shifted to **pump 2**, which will come on first next time.

During peak periods, when **pump 1** cannot cope, **pump 1** will come on at 3.0 feet, **pump 2** will come on at 5.0 feet, and pump down to 2.0 feet. The setpoints are then shifted to **pump 2**, which will come on **first next time**.

If neither pump can cope, and the level rises to 8.5 feet, then the alarm relay (Relay 5) will come on, and go off when the level falls to 8.0 feet. This will indicate insufficient capacity of the pumps. The display will show the level in the sump and mA output 1 will be representative of level where 4mA = empty level (0%) and 20mA = 10.0 feet (100%)

To program the *Ultra Twin* for **Example 1 Sump control (pump down)** using the **Quick Setup** menu proceed as follows.

If required access the **Program Mode**

Key in the **passcode** 1997 and press **ENTER**

At the **Quick Setup** menu press **ENTER** and as prompted, by the questions, select the relevant option and **ENTER**.

<b>Question</b>	<b>Option</b>
Application	2 = Pump
Level, Pump Up/Down	2 = Pump Down
No. of Pumps	2 = 2 Pumps
Pump Duty	3 = Alt DutAss
Pump No. 1	1 = Set to Relay 1
Pump No. 2	2 = Set to Relay 2
No. of Alarms	1 = 1 Alarm
Type Alarm 1	1 = High
Alarm No.1	5 = Set to Relay 5
Xducer (P1-101)	2 = dB6
Measnt Units (P*104)	4 = feet
Empty Level (P1-105)	11.0 (feet)
Span (P1-106)	10.0 (feet)

Programming is now complete and the unit can be returned to the run mode, press **CANCEL** until **Run Mode?** Is displayed on the LCD press **ENTER**, and the *Ultra Twin* will return to the **Run Mode**.

**Note**

If relay setpoints do not meet the exact requirements of the application, they can be modified to suit by pressing ENTER when, “For More Options Hit Enter”, is displayed, and entering new values to relay setpoints as required. Alternatively, the relevant relay setpoint can be accessed either by the main menu system or directly via parameter number and changed as necessary.

## **Example 2 Reservoir Control (pump up)**

A reservoir is typically used to temporarily hold liquid, and when the level reaches a specific low point, the reservoir is pumped up.

The application is to be assigned to Point (transducer) 2.

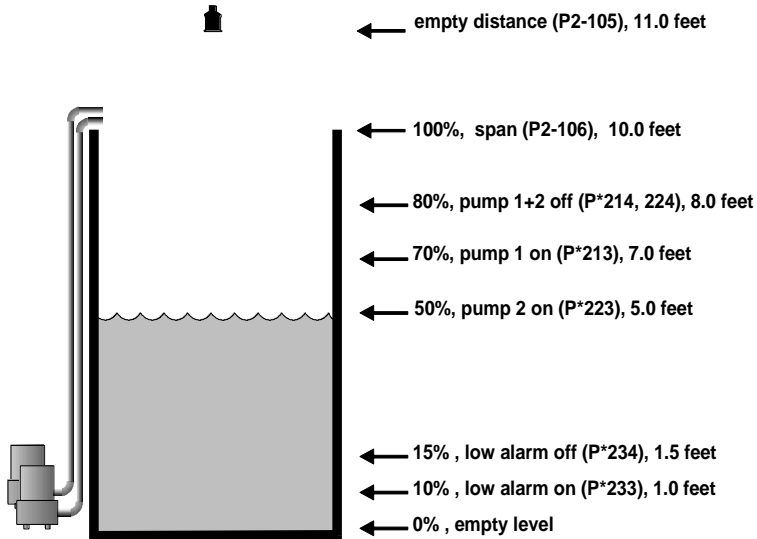

In this example, there are two pumps, which will be set to alternate duty assist, so they come on alternately. Pump 1 is to be set to Relay 1, Pump 2 to Relay 2, and the low-level alarm to relay 3.

This will operate as follows. During normal operation, **pump 1** will come on at 7.0 feet and pump up to 8.0 feet. The setpoints are then shifted to **pump 2**, which will come on **first next time**.

During peak periods, when **pump 1** cannot cope, **pump 1** will come on at 7.0 feet, **pump 2** will come on at 5.0 feet and pump up to 8.0 feet. The setpoints are then shifted to **pump 2**, which will come on **first next time**.

If both pumps cannot cope, and the level falls to 1.0 feet, then the alarm relay (Relay 3) will come on and go off when the level rises to 1.5 feet. This will indicate insufficient capacity of the pumps.

The display will show the level in the sump and the mA output will be representative of level where 4mA = empty level (0%) and 20mA = 10.0 feet (100%)

To program the *Ultra Twin* for **Example 2 Reservoir Control (pump up)** by using the **Quick Setup** menu proceed as follows.

If required access the **Program Mode**

Key in the **passcode** 1997 and press **ENTER**

At the **Quick Setup** menu press the  hot key and toggle to Point 2 display and press **ENTER** and then as prompted, by the questions, select the relevant option and **ENTER**.

Question	Option
Application	2 = Pump
Level, Pump Up/Down	3 = Pump Up
No. of Pumps	2 = 2 Pumps
Pump Duty	3 = Alt DutAss
Pump No. 1	1 = Set to Relay 1
Pump No. 2	2 = Set to Relay 2
No. of Alarms	1 = 1 Alarm
Type Alarm 1	2 = Low
Alarm No.1	3 = Set to Relay 3
Xducer (P1-101)	2 = dB6
Measnt Units (P*104)	4 = feet
Empty Level (P1-105)	11.0 (feet)
Span (P1-106)	10.0 (feet)

Programming is now complete and the unit can be returned to the run mode, press **CANCEL** until **Run Mode?** Is displayed on the LCD press **ENTER**, and the *Ultra Twin* will return to the **Run Mode**.

#### Note

If relay setpoints do not meet the exact requirements of the application, they can be modified to suit by pressing **ENTER** when, “For More Options Hit Enter”, is displayed, and entering new values to relay setpoints as required. Alternatively, the relevant relay setpoint can be accessed either by the main menu system or directly via parameter number and changed as necessary.

## Flow

If you want to set-up a **flow** application, as described in the following examples, then choose **3** for **Flow**. You will then be given a choice of **Primary Measuring Devices** to choose from.

### Choose Your Application

There are five categories of **Primary Measuring Device**, which are all described in this chapter. They are **exponential**, **BS3860 flumes**, **BS3860 weirs**, **special** and **universal**.

Calculations for flow can be performed using absolute or ratiometric calculations. The answer will be the same, the choice of calculation method being limited to the amount of information available, with regards to the primary measuring device.

For ratiometric calculation it is normally sufficient to know the maximum flow at maximum head for the device in question. All types of primary measuring devices can be set up with a choice of alarms.

If you want to set-up a basic **exponential device**, as described in the following **example 1**, then choose **3** for **Flow**, followed by **1** for **exponent**. You then need to select the **primary measuring device** for your application from the following available options: **suppressed rectangular weir**, **Cipolletti (trapezoidal) weir**, **Venturi flume**, **Parshall flume**, **Leopold Lago flume**, **V notch weir** or **other**, for any other type of exponential device.

To set-up an application for a **BS3680 flume**, as described in the following **example 2**, then choose **3** for **Flow** followed by **2** for **3680 Flume**. You then need to select the **primary measuring device** for your application from the following available options: **rectangular flume with or without hump**, **U-throated flume with or without hump**.

To set-up an application for a **BS3680 weir**, as described in the following **example 3**, then choose **3** for **Flow** followed by **3** for **3680 Weir**. You then need to select the **primary measuring device** for your application from the following available options: **rectangular weir**, **V notch full 90° (90degrees)**, **V notch half 90° (53 degree 8 minutes)**, **V notch quarter 90° (28 degree 4 minutes)** or a **Broad Crested Weir**.

To set-up an application for a device contained in **special**, choose **3** for **Flow** followed by **5** for **Special**. You then need to select the **primary measuring device** for your application from the following available options: **palmer Bowlus flume**, **H-flume** or a **V notch**, other than BS3680.

For devices which do not match any of the above devices the application can be setup using a **universal flow calculation**, to select this option choose **3** for **Flow** followed by **6** for **universal**. You then need to select the **primary measuring device** for your application from the following available options: **linear flow** or **curved flow**.

Once you have chosen your application you will be asked a series of questions which are answered by choosing the appropriate option as detailed in the flow chart below. Once all the questions have been answered you will be prompted to provide further information, as detailed in the tables below, in order to complete the programming of the unit.

# Quick Setup Menu

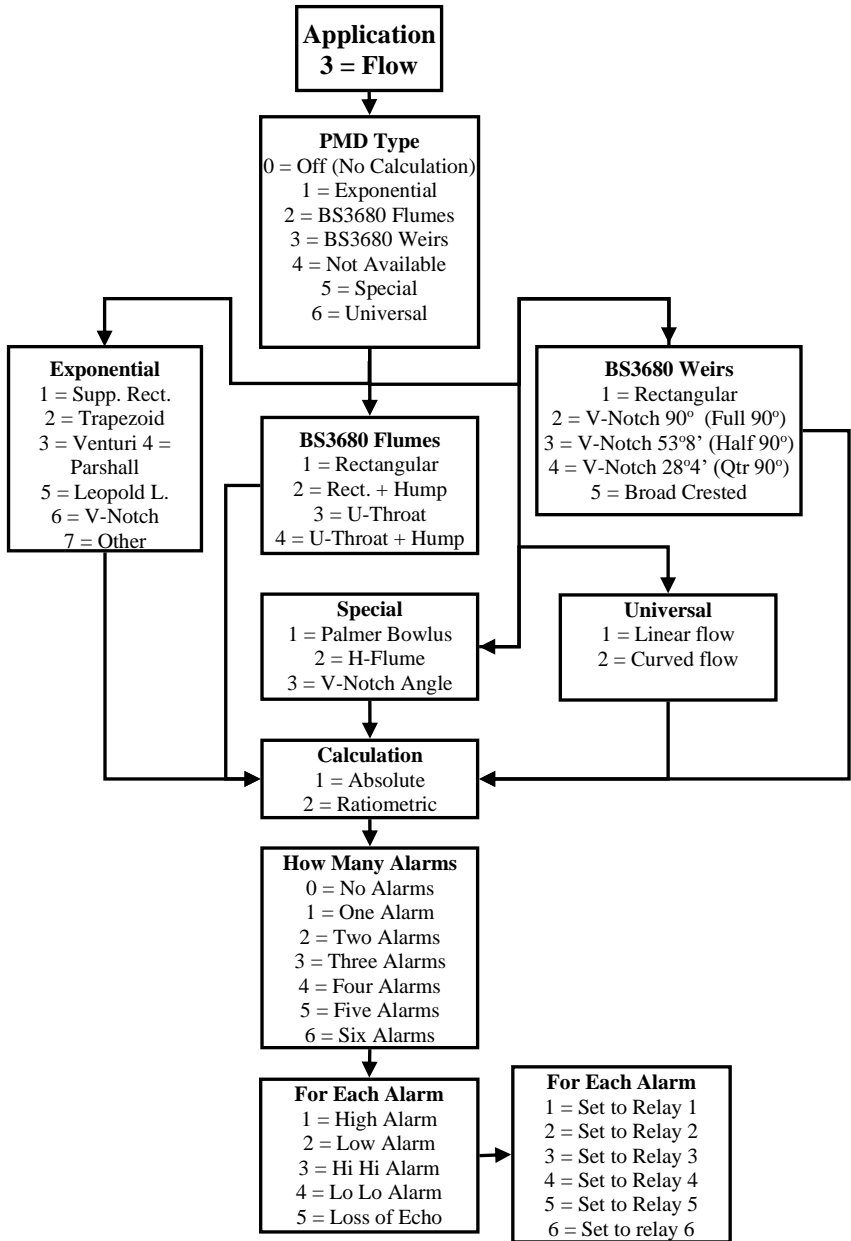



Wait ....

Parameter	Default	Description
P101 Transducer	1 = dB Mach 3	Type of Transducer to be used.
P706 Volume Units	1 = Litres	Units of flow as on display and used for calculations. 1=litres                      2 = cubic metres 3=cubic feet                4 = UK gallons 5=US gallons                6 = Mil.USG
P707 Time Units	1 = per second	Units of time that volume units will be displayed and calculated in. 1= units/sec.                2= units/min. 3= units/hour                4= units/day
P104 Measurement Units	4 = feet	Units used to enter dimensions, and displayed where appropriate. 1 = metres                    2 = centimetres 3 = millimetres              4 = feet 5 = inches
P105 Empty Level	7.956 feet	Distance from the face of the transducer to the material at the bottom of the measuring element.
P703 Minimum Head	0.000 feet	Distance from empty point (P105) to zero flow.
P704 Max Head	7.956 feet	Distance from zero flow to max flow. It should be noted that any change to P704 updates P106 Span and vice versa.
P824 Totaliser Allocation	1= Point 1	Enables the Totaliser to a specific point of flow measurement or a combination of flow when both points set to measure Flow. For full list of options see <b>P824 in Chapter 5 Parameter Guide.</b>
P815 Aux Mode	2 = Level	Enables the Auxiliary display line to display additional information whilst in RUN mode. For full list of options see <b>P815 in Chapter 5 Parameter Guide.</b>

Parameter	Default	Description
P816 Aux Source	0=Off	Determines which point or combination of points, that the Auxiliary display line will relate to. For full list of options see <b>P816</b> in <b>Chapter 5 Parameter Guide</b> .
P823 Totaliser Multiplier	4=*1	Sets the factor by which the calculated volume will be divided or multiplied by before being displayed. 1 = /1000                      2 = /100 3 = /10                              4 = *1 5 = *10                              6 = *100 7 = *1,000                      8 = *10,000 9 = *100,000                      10 = *1,000,000

The remaining parameters required to finalise the setup of your application will follow on immediately from the above. These parameters relate to details required to carry out the calculation for flow and will be dependent on the Primary Measuring Device chosen and the method of calculation chosen, please enter values for the parameters concerned as requested.

Parameter	Default	Description
P705 Max. Flow	0.000	When requested enter the known maximum flowrate, in units of volume (P706) and Time (P707) which occurs at maximum head (P704)
P710 Dim. "A"	0	When requested enter, in measurement units, P104, the required dimension.
P711 Dim. "B"	0	When requested enter, in measurement units, P104, the required dimension.
P712 Dim. "C"	0	When requested enter, in measurement units, P104, the required dimension.
P713 Dim. "D"	0	When requested enter, in measurement units, P104, the required dimension.
P717 Exponent	Dependent on chosen PMD	Where available the <i>Ultra Twin</i> will automatically enter the default exponent value for the PMD chosen, but this can be changed if required. When P700 = 7 (Other), enter the exponent value as defined by the manufacturer of the PMD.
P718 K Factor		Enter the 'K' factor for the PMD, obtained from the manufacture's specification

**For More Options Hit Enter**

<b>Parameter</b>	<b>Set Value</b>	<b>Description</b>
P213 / P214 Relay 1 ON/OFF	depends on application	Set required Alarm Setpoints.
P223 / P224 Relay 2 ON/OFF	depends on application	Set required Alarm Setpoints.
P233 / P234 Relay 3 ON/OFF	depends on application	Set required Alarm Setpoints.
P243 / P244 Relay 4 ON/OFF	depends on application	Set required Alarm Setpoints.
P253 / P254 Relay 5 ON/OFF	depends on application	Set required Alarm Setpoints.
P263 / P264 Relay 6 ON/OFF	depends on application	Set required Alarm Setpoints.
P708 Flow Decimal	2	Set the number of decimal points required in the flow rate display
P709 Flow Cut Off	5.00%	Enter as a percentage of maximum flow, the minimum flow rate to be added to the totaliser.
P830 mA Out Range	2= 4 to 20 mA	What the mA output uses for the range. 0= Off, 1= 0 to 20 mA, 2= 4 to 20 mA, 3= 20 to 0 mA, 4= 20 to 4 mA.
P870 Fill Damping	32.8084 feet	Rate of maximum fill rate (set above the actual fill rate of the vessel).
P871 Empty Damping	32.8084 feet	Rate of maximum empty rate (set above the actual empty rate of the vessel).

The default values used for determining the **relay setpoints**, when setting **Alarm** relays, via the **Quick Setup** menu are entered as a % of span and are as follows.

<b>Relay Function</b>	<b>Alarm ID</b>	<b>On Setpoint</b>	<b>Off Setpoint</b>
Alarm	Hi Hi	90%	85%
Alarm	High	85%	80%
Alarm	Low	10%	15%
Alarm	Lo Lo	5%	10%

**Note**

When using the Quick Setup Menu relays will be allocated to the point of measurement you are currently setting up and the availability of relays will depend on the number of relays used when setting up the previous point of measurement via the Quick Setup Menu for that point.

## Exponential Devices

If the primary measuring device is a simple exponential device, then an exponent value is required. The *Ultra Twin* will automatically enter the exponent value for the device chosen as detailed in the table below.

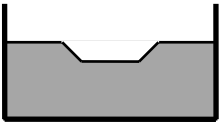
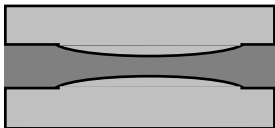
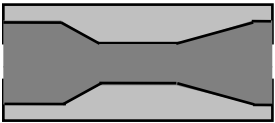
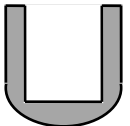
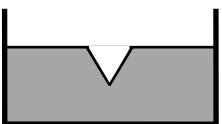
Exponent Type			Exponent
Suppressed Weir	Rectangular		1.50
Cipolletti (Trapezoidal) Weir			1.50
Venturi Flume			1.50
Parshall Flume			Default = 1.55 but value can be set as required via P717
Leopold Lagco Flume			1.55
V-Notch Weir			2.50
Other		As per manufacturer	Value to be set as required via P717

## **Point of Measurement**

The transducer must be above the **maximum head P704** by at least the near **blanking distance P107**.

For **Suppressed Rectangular, Trapezoidal and V-notch**, weirs, the head is measured **upstream** at a minimum distance of **3 times maximum head** from the weir plate to ensure the surface of the liquid is not affected by turbulence or drawdown. (See DRWG. 1)

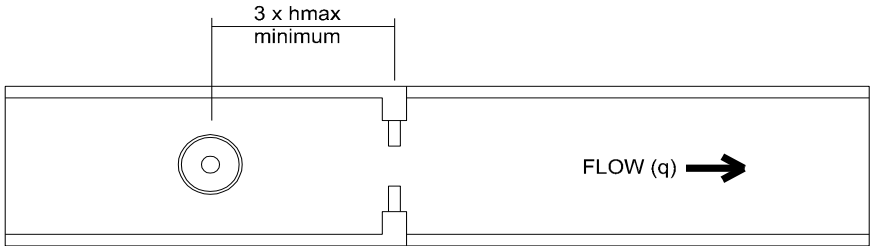

DRWG. 1.

In the case of a **Venturi flume** the point of measurement should be **150 mm (6 inches) upstream** from the beginning of the **converging section** and for a **Parshall flume** **2/3 the length of the converging section** upstream of the **throat** section. See DRWG 2 and 3).

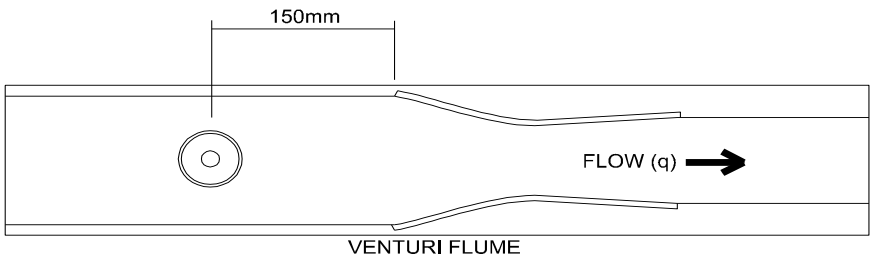

DRWG. 2.

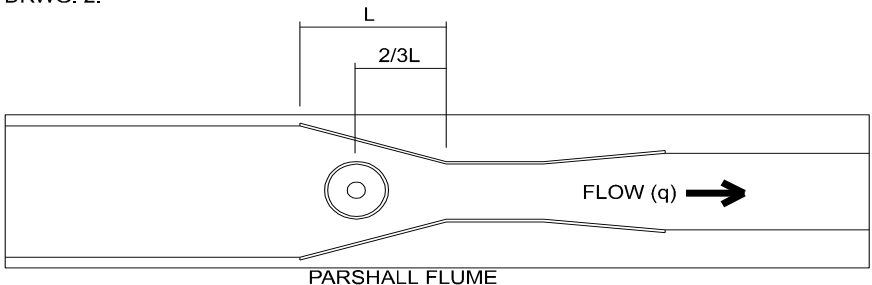

DRWG. 3.

For a **Leopold Lagco** flume the head is measured at a point **upstream** of the beginning of the converging section as detailed in the table below. (See DRWG 4)

Flume Size		Point of Measurement	
mm	inches	mm	inches
100 - 305	4 - 12	25	1.0
380	15	32	1.3
455	18	38	1.5
530	21	44	1.8
610	24	51	2.1
760	30	64	2.5
915	36	76	3.0
1065	42	89	3.5
1220	48	102	4.0
1370	54	114	4.5
1520	60	127	5.0
1675	66	140	5.5
1830	72	152	6.0

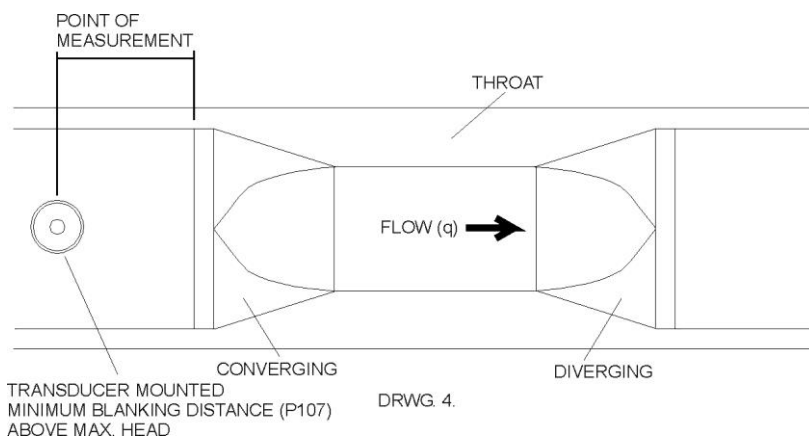

When any **Other** device is chosen please consult the manufacturer of the device for details of where the point of measurement should be located but ensure that it is chosen such that the surface of the liquid is not effected by turbulence or drawdown.

## **Calculations**

### **ABSOLUTE**

If the flow calculation is to be **absolute P702 = 1** the flow will be calculated using the formula(s) as follows:

Exponent Type	Formula	Exponent	K Factor
Suppressed Rectangular Weir (Without End Contractions)	$Q=KLh^x$ Where: $Q$ =Flow $K$ = <b>K factor</b> $L$ =crest length of weir $h$ =head $x$ = <b>exponent</b>	1.50 Automatically selected by the Ultra Twin	Automatically calculated, dependent on measurement, flow and time units chosen.
Cipolletti (Trapezoidal) Weir	$Q=KLh^x$ Where: $Q$ =Flow $K$ = <b>K factor</b> $L$ =crest length of weir $h$ =head $x$ = <b>exponent</b>	1.50 Automatically selected by the Ultra Twin	Automatically calculated, dependent on measurement, flow and time units chosen.
Venturi Flume	$Q=Kh^x$ Where: $Q$ =Flow $K$ = <b>K factor</b> $h$ =head $x$ = <b>exponent</b>	1.50 Automatically selected by the Ultra Twin	Enter value of K Factor (P718) as required
Parshall Flume	$Q=Kh^x$ Where: $Q$ =Flow $K$ = <b>K factor</b> $h$ =head $x$ = <b>exponent</b>	Automatically calculated dependent on throat size (P719)	Automatically calculated, dependent on throat size and measurement, flow and time units chosen.
Leopold Lagco Flume	$Q=KD^{0.0953}h^x$ Where: $Q$ =Flow $K$ = <b>K factor</b> $D$ =pipe diameter $h$ =head $x$ = <b>exponent</b>	1.55 Automatically selected by the Ultra Twin	Automatically calculated, dependent on measurement, flow and time units chosen.



Exponent Type	Formula	Exponent	K Factor
V-Notch Weir	$Q=Kh^x$ Where: $Q$ =Flow $K$ = <b>K factor</b> $h$ =head $x$ = <b>exponent</b>	2.50 Automatically selected by the Ultra Twin	Automatically calculated, dependent on measurement, flow and time units chosen.
Other	$Q=Kh^x$	Enter value as required	Enter value as required
Contracted Rectangular Weir (With End Contractions)	$Q=K(L-0.2*h)h^x$ Where: $Q$ =Flow $K$ = <b>K factor</b> $L$ =crest length of weir $h$ =head $x$ = <b>exponent</b>	1.50 Automatically selected by the Ultra Twin	Automatically calculated, dependent on measurement, flow and time units chosen.

### RATIOMETRIC

If the flow calculation is to be **ratiometric P702 = 2** the flow will be calculated using the formula:  $q = q_{cal} (h/h_{cal})^x$

Where:  $q$  = flowrate  
 $q_{cal}$  = **flowrate at maximum head (705)**  
 $h$  = head  
 $h_{cal}$  = **maximum head (P704)**  
 $x$  = exponent (**P717**)

## Example 1 'V' Notch Weir

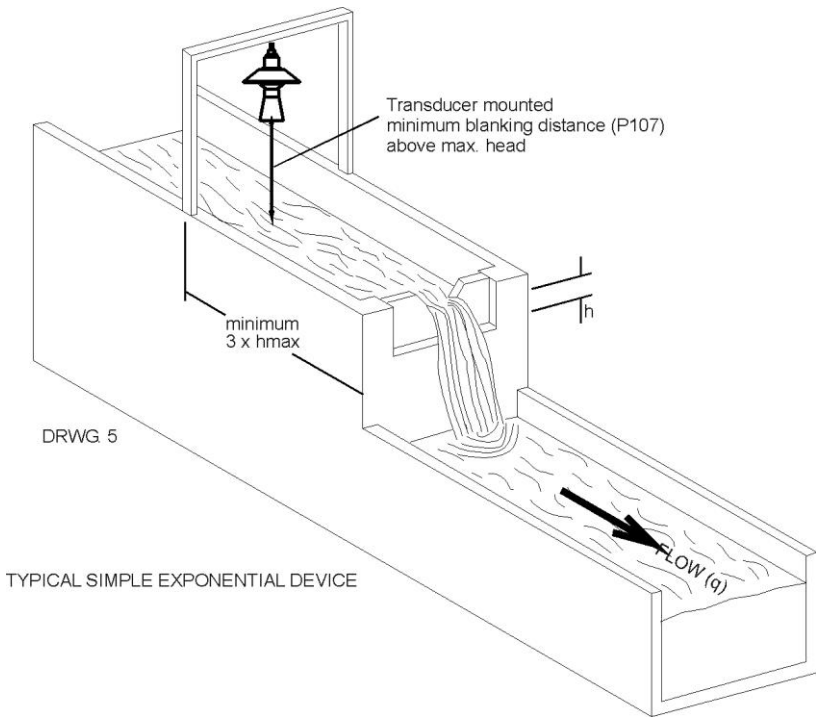

### **The application is to be assigned to Point (transducer) 1.**

In this example, it is required to calculate the flow through a Simple Exponential Device, which on this occasion is a V-Notch Weir. The K factor for the weir is unknown so ratiometric calculation will be used, and the flow rate is to be calculated in millions of US gallons/day.

The distance from the end of the transducer horn (dB Mach 3) to **zero flow (P105)** is 40 inches and **max head (P704)** is 15 inches, **maximum flow (P705)** is known to be 2.2million US gallons/day.

To program the *Ultra Twin* for **Example 1 V-Notch Weir** by using the **Quick Setup** menu proceed as follows.

If required access the **Program Mode**

Key in the **passcode** 1997 and press **ENTER**

At the **Quick Setup** menu press **ENTER** and as prompted, by the questions, select the relevant option and **ENTER**.

Question	Option
Application	3 = Flow
PMD Type	1 = Exponent
Exponent	6 = V notch.
Calculation	2 = Ratiometric.
No. of Alarms	0 = No Alarms
Xducer (P1-101)	1 = dB Mach3
Volume Units (P1-706)	6 = Mil USG
Time Units (P1-707)	4 = Per Day
Measnt. Units (P*104)	5 = inches
Empty Level (P1-105)	40 inches
Minimum Head (P1-703)	0.000 inches
Maximum Head (P1-704)	15 inches
Total Alloc. (P1-824)	1 = Point 1
Aux. Mode (P1-815)	2 = Level
Aux. Source (P1-816)	0 = Off
Total Multiplier (P1-823)	1 = /1000
Maximum Flow (P1-705)	2.2

Programming is now complete, and the unit can now be returned to the run mode, press **CANCEL** until **Run Mode?** Is displayed on the LCD press **ENTER**, and the *Ultra Twin* will return to **Run Mode**.

## BS3680 Flumes

### Point of Measurement

The transducer must be above the **maximum head P704** by at least the near blanking distance **P107**.

For a **Rectangular** and **U-throated** flume, the head is measured at **3 to 4 times the maximum head upstream** from the beginning of the **converging section**, to ensure the surface of the liquid is not affected by turbulence. (See DRWG 6)

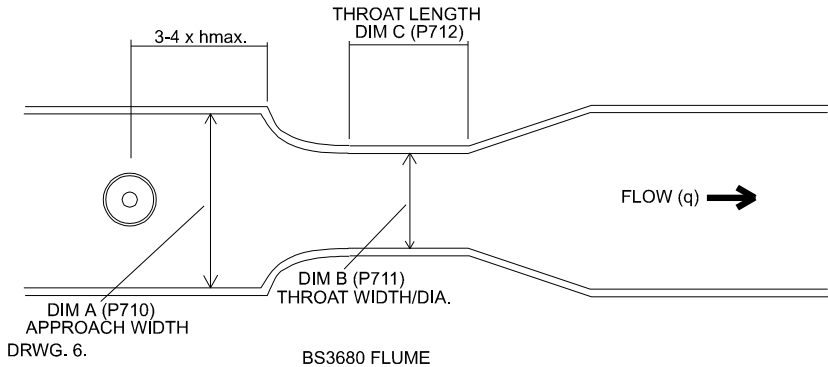

## **Calculations**

### **Rectangular Flume**

#### **ABSOLUTE**

If the flow calculation is to be **absolute P702 = 1** the flow will be calculated using the formula:  $q = (2/3)^{1.5} gn^{0.5} C_s C_v C_d b h^{1.5}$

Where:

- q = flowrate
- gn = gravitational acceleration (nominal value = 980.66 cm/s<sup>2</sup>)
- C<sub>s</sub>** = **shape coefficient** (value = 1)
- C<sub>v</sub>** = **velocity coefficient** calculated by Ultra Twin **P721**
- C<sub>d</sub>** = **discharge coefficient** calculated by Ultra Twin **P722**
- b** = **throat width P711**
- h = head

#### **RATIOMETRIC**

If the flow calculation is to be **ratiometric P702 = 2** the flow will be calculated using the formula:  $q = q_{cal} (C_v / C_{vcal}) (C_d / C_{dcal}) (h / h_{cal})^{1.5}$

- Where:
- q = flowrate
  - q<sub>cal</sub>** = **flowrate at maximum head P705**
  - C<sub>v</sub>** = **velocity coefficient** calculated by Ultra Twin **P721**
  - C<sub>vcal</sub> = velocity coefficient at maximum head
  - C<sub>d</sub>** = **discharge coefficient** calculated by Ultra Twin **P722**
  - C<sub>dcal</sub> = discharge coefficient at maximum head
  - h = head
  - h<sub>cal</sub>** = **maximum head P704**

## U-Throated Flume

### ABSOLUTE

If the flow calculation is to be **absolute P702 = 1** the flow will be calculated using the formula:  $q = (2/3)^{1.5} g_n^{0.5} C_u C_v C_d b h^{1.5}$

Where:  $q$  = flowrate

$g_n$  = gravitational acceleration (nominal value = 980.66 cm/s<sup>2</sup>)

$h$  = head

$C_u$  = **shape coefficient** calculated by Ultra Twin **P724**

$C_v$  = **velocity coefficient** calculated by Ultra Twin **P721**

$C_d$  = **discharge coefficient** calculated by Ultra twin **P722**

$b$  = **throat width P711**

### RATIOMETRIC

## U-Throated Flume

If the flow calculation is to be **ratiometric P702 = 2** the flow will be calculated using the formula:

$$q = q_{cal} (C_v / C_{vcal}) (C_d / C_{dcal}) (C_u / C_{ucal}) (h / h_{cal})^{1.5}$$

Where:  $q$  = flowrate

$q_{cal}$  = **flowrate at maximum head P705**

$C_v$  = **velocity coefficient** calculated by Ultra Twin **P721**

$C_{vcal}$  = velocity coefficient at maximum head

$C_d$  = **discharge coefficient** calculated by Ultra Twin **P722**

$C_{dcal}$  = discharge coefficient at maximum head

$C_u$  = **shape coefficient P724**

$C_{ucal}$  = shape coefficient at maximum head

$h$  = head  $h_{cal}$  = **maximum head P704**

## **Example 2 BS3680 U-Throated Flume**

In this example, it is required to calculate to BS3680 the flow through a U-Throated Flume without any hump. Absolute calculation will be used, and there is a requirement for an alarm to indicate a low flow condition which will be set to Relay 1. The flow rate is to be displayed in **millions of US gallons/hour** and the totaliser is also to record the flow in **millions of US gallons**, the resettable totaliser is to be displayed during RUN.

**The application is to be assigned to Point (transducer) 2.**

The distance from the end of the transducer horn (dB Mach 3) to **zero flow (P2-105)** is 35 inches and **max head (P2-704)** is 15 inches, **maximum flow (P2-705)** will be calculated by the *Ultra Twin* as 0.1784 Mil USG/Hour.

The dimensions of the flume are as follows:

<b>Approach Channel diameter (Dim "A") P2-710</b>	= 28 inches
<b>Throat diameter (Dim "B") P2-711</b>	= 20 inches
<b>Throat length (Dim "C") P2-712</b>	= 40 inches

To program the *Ultra Twin* for **Example 2 BS3680 U-Throated Flume** by using the **Quick Setup** menu proceed as follows.

If required access the **Program Mode**

Key in the **passcode** 1997 and press **ENTER**

At the **Quick Setup** menu press the  hot key and toggle to Point 2 display and press **ENTER** and then as prompted, by the questions, select the relevant option and **ENTER**.

Question	Option
Application	3 = Flow
PMD Type	2 = 3680 Flume
3680 Flumes	3 = U Throat
Calculation	1 = Absolute
No. of Alarms	1 = 1 Alarm
Type Alarm 1	2 = Low
Alarm No 1	1 = Set Relay 1
Xducer (P2-101)	1 = dB Mach3
Volume Units (P2-706)	6 = Mil. USG
Time Units (P2-707)	3 = Per Hour
Measnt. Units (P*104)	5 = inches
Empty Level (P2-105)	35.0 inches
Minimum Head (P2-703)	0.000 inches
Maximum Head (P2-704)	15 inches
Total Alloc. (P2-824)	1 = Point 1
Aux. Mode (P2-815)	7 = Totaliser (R)
Aux. Source (P2-816)	1 = Point 1
Total Multiplier (P2-823)	4 = *1
Approach. Dia. (P2-710)	28.0 inches
Throat Dia. (P2-711)	20.0 inches
Throat Len. (P2-712)	40.0 inches

Programming is now complete and the unit can now be returned to the run mode, press **CANCEL** until **Run Mode?** Is displayed on the LCD press **ENTER**, and the *Ultra Twin* will return to **Run Mode**.

**Note**

If relay setpoints do not meet the exact requirements of the application, they can be modified to suit by pressing **ENTER** when, “For More Options Hit Enter”, is displayed, and entering new values to relay setpoints as required. Alternatively, the relevant relay setpoint can be accessed either by the main menu system or directly via parameter number and changed as necessary.



## BS3680 Thin Plate Weirs

### Point of Measurement

The transducer must be above the **maximum head P704** by at least the near blanking distance **P107**.

For **Rectangular** and **V-notch** weirs, the head is measured at a point 4 to 5 times the **maximum head upstream** from the weir plate, to ensure the surface of the liquid is not affected by turbulence or drawdown. (See DRWG 8)

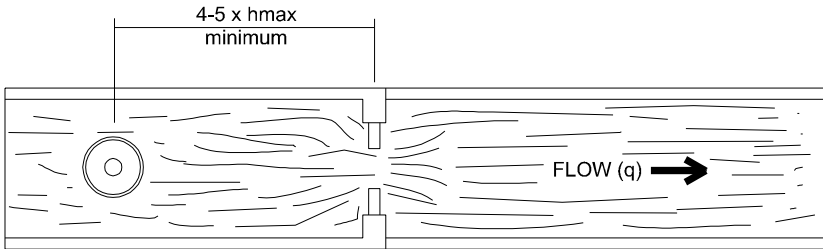

DRWG. 8.

BS3680 WEIR

### Calculations

#### BS 3680 Rectangular Weir

##### ABSOLUTE

If the flow calculation is to be **absolute P702 = 1** the flow will be calculated using the formula:  $q = C_e \frac{2}{3}(2gn)^{0.5} b_e h_e^{1.5}$

Where:  $q$  = flowrate

**C<sub>e</sub>** = **discharge coefficient** calculated by Ultra Twin **P723**

$gn$  = gravitational acceleration (nominal value = 980.66 cm/s<sup>2</sup>)

$b_e$  = effective approach width where **b** is **approach width**

(Dim "A") **P710**

$h_e$  = effective head

## RATIOMETRIC

If the flow calculation is to be **ratiometric P702 = 2** the flow will be calculated using the formula:  $q = q_{cal} C_e / C_{ecal} (h_e / h_{ecal})^{1.5}$

Where:  $q$  = flowrate  
 $q_{cal}$  = **flowrate at maximum head P705**  
 $C_e$  = **discharge coefficient** calculated by Ultra Twin **P723**  
 $C_{ecal}$  = discharge coefficient at maximum head  
 $h_e$  = effective head  
 $h_{ecal}$  = effective head at maximum head

## BS 3680 V-Notch Weir

### ABSOLUTE

If the flow calculation is to be **absolute P702 = 1** the flow will be calculated using the formula:  $q = C_e 8 / 15 \tan(\theta/2) (2gn)^{0.5} h^{2.5}$

Where:  $q$  = flowrate  
 $C_e$  = **discharge coefficient** calculated by Ultra Twin **P723**  
 $\theta$  = v-notch angle  
 $gn$  = gravitational acceleration (nominal value = 980.66 cm/s<sup>2</sup>)  
 $h$  = head

Ultra Twin presets the angle ( $\theta$ ) on selection of the chosen device this angle is **90 degrees** for a BS 3680 **full 90 degree V notch** weir, **53 degrees 8 minutes** in the case of the BS3680 **half 90 degree V notch** weir and **28 degree 4 minutes** in the case of the BS3680 **quarter 90 degree V notch** weir.

## RATIOMETRIC

If the flow calculation is to be **ratiometric P702 = 2** the flow will be calculated using the formula:  $q = q_{cal} C_e(h) / C_e(h_{cal}) (h / h_{cal})^{2.5}$

Where:  $q$  = flowrate  
 $q_{cal}$  = **flowrate at maximum head P705**  
 $C_e(h)$  = discharge coefficient for head  
 $C_e(h_{cal})$  = discharge coefficient for maximum head  
 $h$  = head  
 $h_{cal}$  = **maximum head P704**

### **Example 3 BS3680 Rectangular Weir**

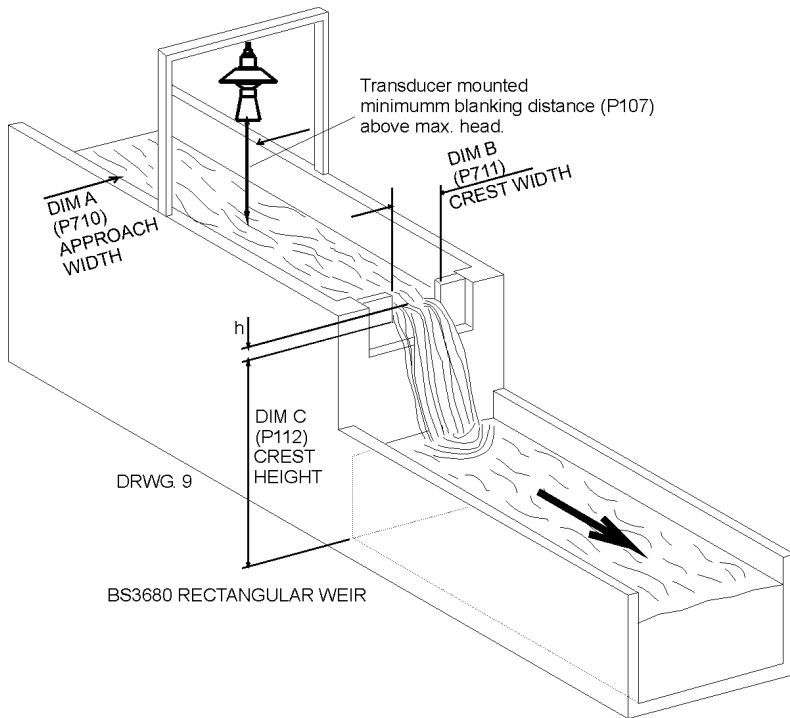

In this example, it is required to calculate to the flow through a BS3680 Rectangular weir. Absolute calculation will be used, and there is a requirement for an alarm to indicate a high flow condition to be set to Relay 3. The flow rate is required to be displayed in **US gallons/minute** and the totaliser is to record the flow in **thousands of US gallons**, the resettable totaliser is to be displayed during RUN.

**The application is to be assigned to Point (transducer) 1.**

The distance from the end of the transducer horn (dB Mach 3) to **zero flow (P1-105)** is 40 inches and **max head (P1-704)** is 16 inches, **maximum flow (P1-705)** will be calculated by the *Ultra Twin* as 2385.63 USG/min.

**Approach width (Dim "A") P1-710 = 18.0 inches**  
**Crest width (Dim "B") P1-711 = 12.0 inches**  
**Crest Height (Dim "C") P1-712 = 10.0 inches**

To program the *Ultra Twin* for **Example 3 BS3680 Weir** by using the **Quick Setup** menu proceed as follows.

If required access the **Program Mode**

Key in the **passcode** 1997 and press **ENTER**

At the **Quick Setup** menu press **ENTER** and as prompted, by the questions, select the relevant option and **ENTER**.

Question	Option
Application	3 = Flow
PMD Type	3 = 3680 Weir
3680 Flumes	1 = Rectangular
Calculation	1 = Absolute
No. of Alarms	1 = 1 Alarm
Type Alarm 1	1 = High
Alarm No 1	3 = Set Relay 3
Xducer	1 = dB Mach3
Volume Units	5 = US gallons
Time Units	2 = Per Minute
Measnt. Units	5 = inches
Empty Level	40.0 inches
Minimum Head	0.000 inches
Maximum Head	16.0 inches
Total Alloc.	1 = Point 1
Aux. Mode	7 = Totaliser
Aux Source	1 =Point 1
Total Multiplier	7 = *1000
App. Width (Dim A)	18.0 inches
Crest Width (Dim B)	12.0 inches
Crest Height (Dim C)	10.0 inches

Programming is now complete, and the unit can now be returned to the run mode, press **CANCEL** until **Run Mode?** Is displayed on the LCD press **ENTER**, and the *Ultra Twin* will return to **Run Mode**.

#### Note

If relay setpoints do not meet the exact requirements of the application, they can be modified to suit by pressing **ENTER** when, “For More Options Hit Enter”, is displayed, and entering new values to relay setpoints as required. Alternatively, the relevant relay setpoint can be accessed either by the main menu system or directly via parameter number and changed as necessary.

## BS3680 Rectangular Broad Crested Weir

### Point of Measurement

The transducer must be above the **maximum head P704** by at least the near **blanking distance P107**.

The head is measured at a point 3 to 4 **times the maximum head upstream** from the weir crest, to ensure the surface of the liquid is not affected by turbulence or drawdown.

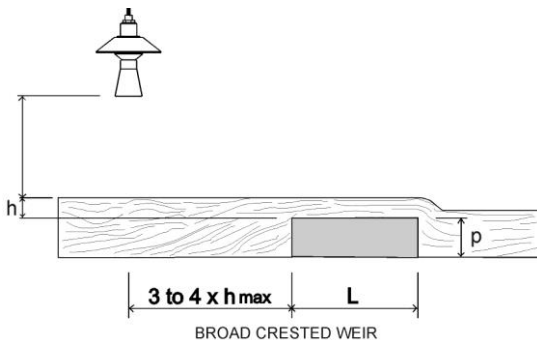

### Calculations

#### ABSOLUTE

If the flow calculation is to be **absolute P702 = 1** the flow will be calculated using the formula:  $q = (2/3)^{1.5} C_e b (gh^3)^{0.5}$

Where:  $q$  = flowrate

$C_e$  = **discharge coefficient** calculated by Ultra Twin **P723**

$b$  = approach width **P710**

$g$  = gravitational acceleration (nominal value =  $980.66 \text{ cm/s}^2$ )

$h$  = head

#### RATIOMETRIC

If the flow calculation is to be **ratiometric P702 = 2** the flow will be calculated using the formula:  $q = q_{\text{cal}} C_e / C_{e\text{cal}} (h_e / h_{e\text{cal}})^{1.5}$

Where:  $q$  = flowrate

$q_{\text{cal}}$  = **flowrate at maximum head P705**

$C_e$  = **discharge coefficient** calculated by Ultra twin **P723**

$C_{e\text{cal}}$  = discharge coefficient at maximum head

$h_e$  = effective head

$h_{e\text{cal}}$  = effective head at maximum head

## Special Devices

### Point of Measurement

The transducer must be above the **maximum head P704** by at least the near **blanking distance P107**.

In the case of a **Palmer Bowlus** flume the point of head measurement should be **half** the value of **Dim “A” P710** **upstream** of the device.

For a **H-Flume** the head measurement is taken at a point **downstream** from the flume entrance as detailed in the table below:

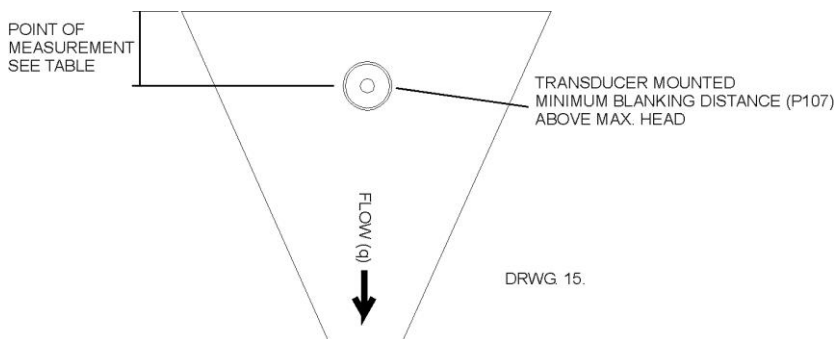

Flume size Dim. “A” P710		Point of Measurement	
cm	Feet	cm	Inches
15.25	0.5	4.7	1.88
23.00	0.75	6.7	2.69
30.05	1.0	9.1	3.63
45.70	1.5	13.5	5.38
61.00	2.0	17.9	7.19
76.20	2.5	22.5	9.00
91.45	3.0	27.2	10.88
137.15	4.5	40.5	16.19

**V-notch angle** weirs, the head is measured **upstream** of the weir plate at a minimum distance of **3 times maximum head** to ensure the surface of the liquid is not affected by turbulence or drawdown. See Exponential devices, above, for further details.

## **Calculations**

### **Palmer Bowlus Flume and H-Flume**

#### **ABSOLUTE**

If the flow calculation is to be **absolute P702 = 1** the flow will be calculated using the formula:  $q = f(h)$

Where:  $q$  = flowrate  
 $f$  = is an 8<sup>th</sup> degree polynomial solution for  $h$  (head)

#### **RATIOMETRIC**

If the flow calculation is to be **ratiometric P702 = 2** the flow will be calculated using the formula:  $q = q_{cal} f(h)/f(h_{cal})$

Where:  $q$  = flowrate  
 $q_{cal}$  = **flowrate at maximum head P705**  
 $f(h)$  = a polynomial solution for  $h$  (head)  
 $f(h_{cal})$  = a polynomial solution for  $h_{cal}$  (maximum head)

### **V-Notch Angle Weir (Non BS 3680)**

#### **ABSOLUTE**

If the flow calculation is to be **absolute P702 = 1** the flow will be calculated using the formula:  $q = C_e 8/15 \tan(\theta/2)(2gn)^{0.5}(h = kh)^{2.5}$

Where:  $q$  = flowrate  
 $C_e$  = **discharge coefficient** calculated by Ultra Twin **P723**  
 $\theta$  = V-notch angle  
 $gn$  = gravitational acceleration  
 $h$  = head  
 $kh$  = compensated head

#### **RATIOMETRIC**

If the flow calculation is to be **ratiometric P702 = 2** the flow will be calculated using the formula:  $q = q_{cal} (h+kh/h_{cal}+kh)^{2.5}$

Where:  $q$  = flowrate  
 $q_{cal}$  = **flowrate at maximum head P705**  
 $h$  = head  
 $kh$  = compensated head

## **Universal Calculations**

### **Point of Measurement**

The transducer must be above the **maximum head P704** by at least the near **blanking distance P107**.

For all **Universal** calculation applications, the point at which the head is measured should be chosen such that the surface of the liquid is not affected by turbulence.

### **Calculations**

#### **Universal Head Vs Flow**

##### **ABSOLUTE**

If the flow calculation is to be **absolute P702 = 1** the flow will be calculated using the formula:  $q = q(h)$

Where:  $q$  = flowrate  
 $q(h)$  = flowrate for head

The desired number of **Breakpoints, (P730 - P793)** are to be entered in pairs in values of **head** and corresponding **flow**. (Minimum of 2 pairs of Breakpoints is required).



This page left blank intentionally

# Chapter 5 Parameter Guide

This section outlines all parameters available in the *Ultra Twin*, as they appear in the menu system.

## Menu System Diagrams

Shown below is a set of charts to show you how all the various parts can be found using the menu system.

### Top Level Menu

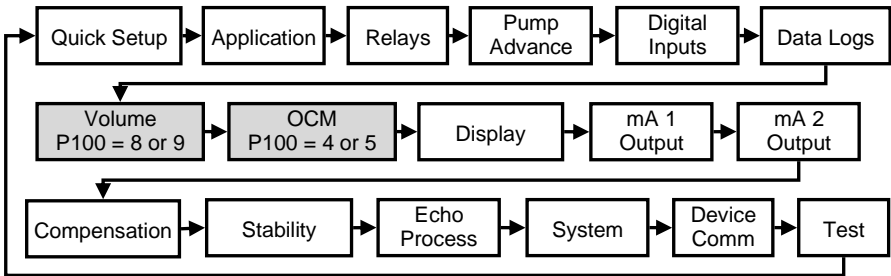

## Application Menu

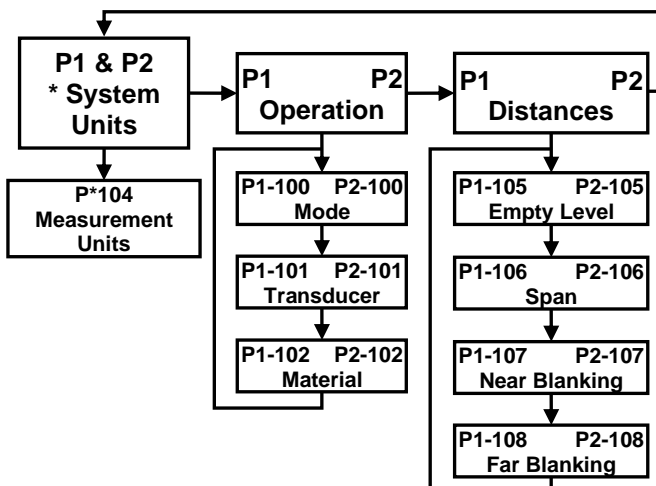

# Relays Menu

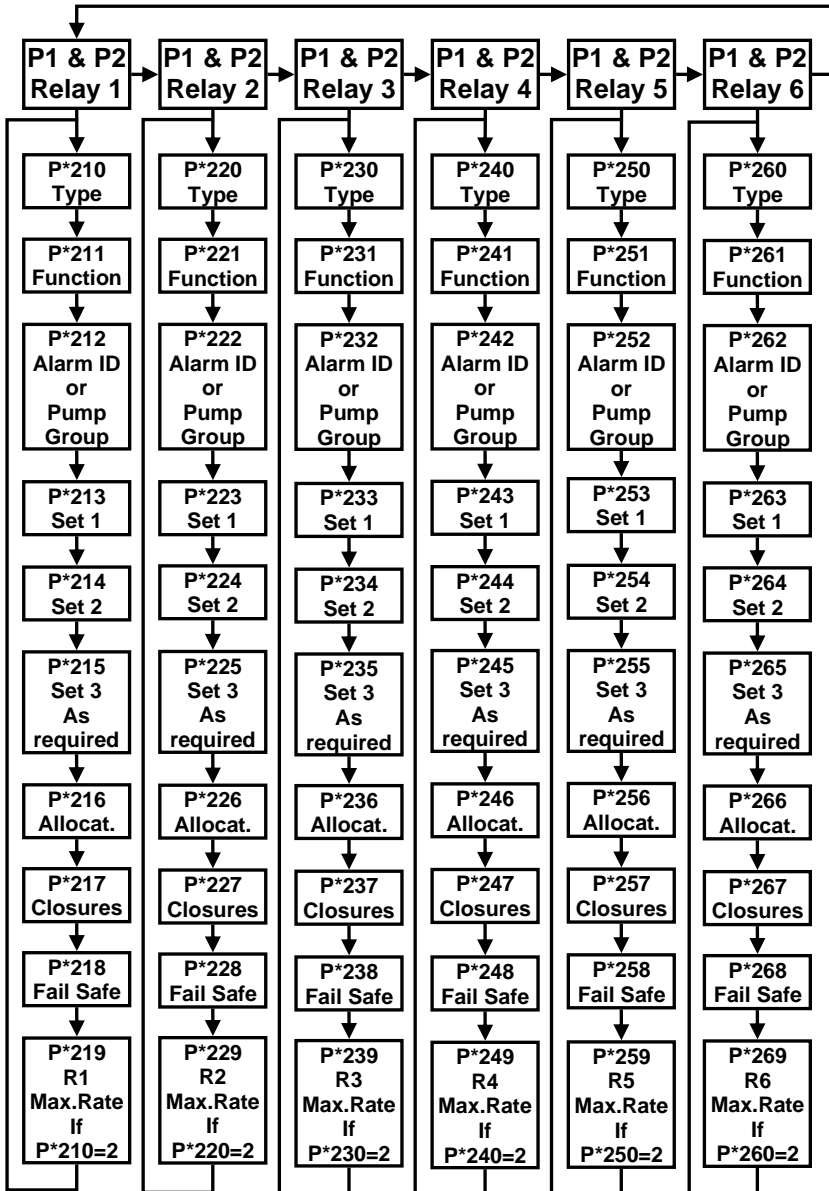

# Pump “Advanced”

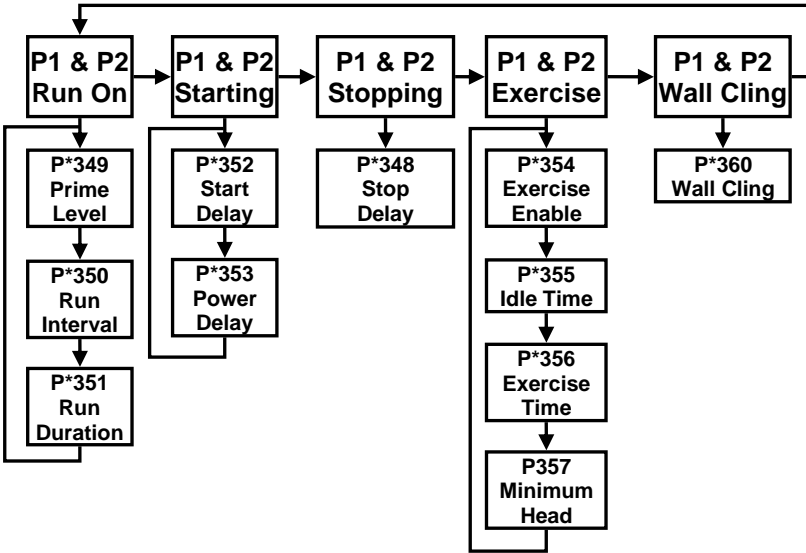

# Digital Inputs

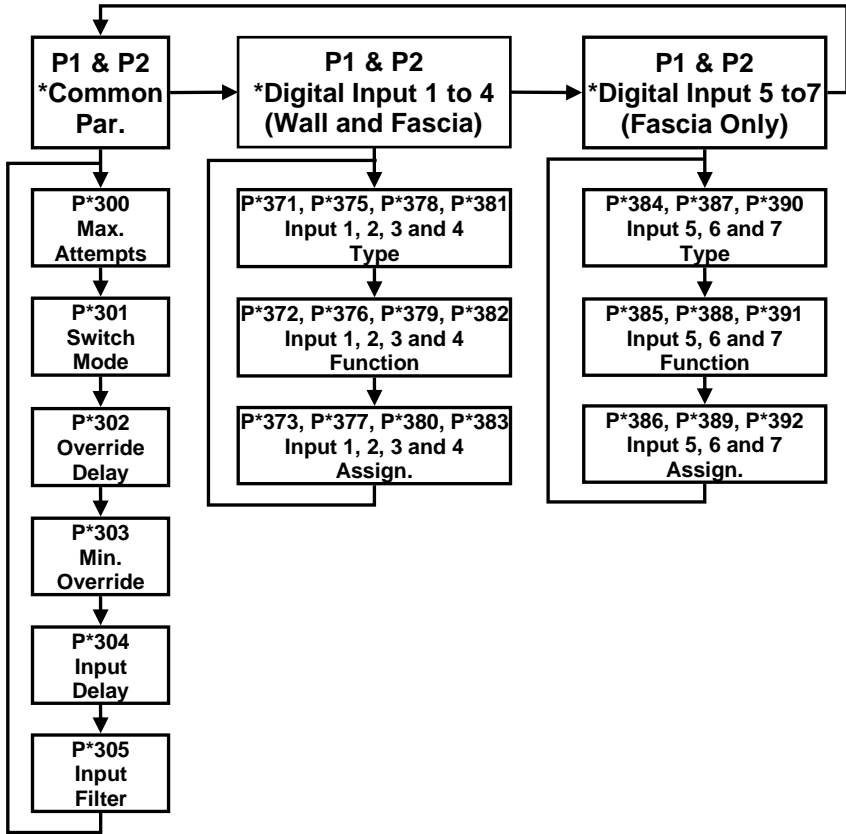

# Data Logs

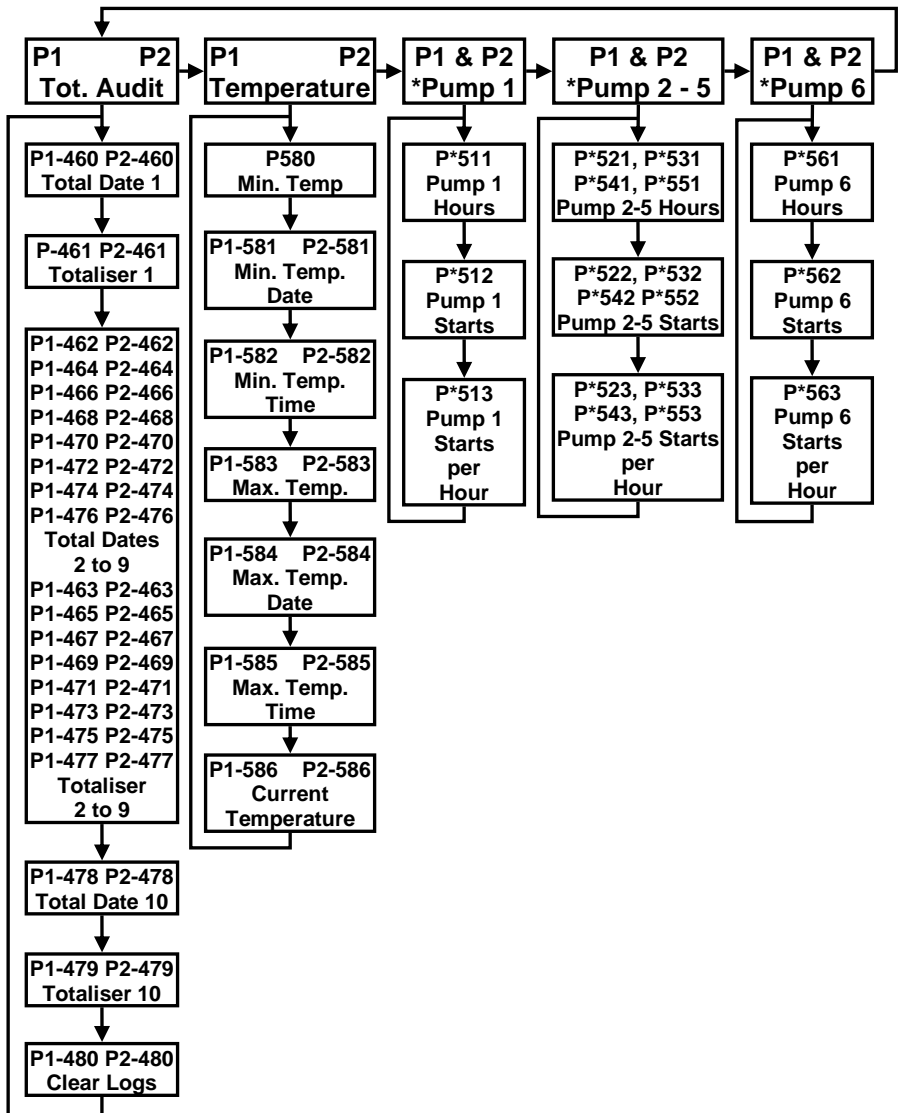

**Volume Menu**

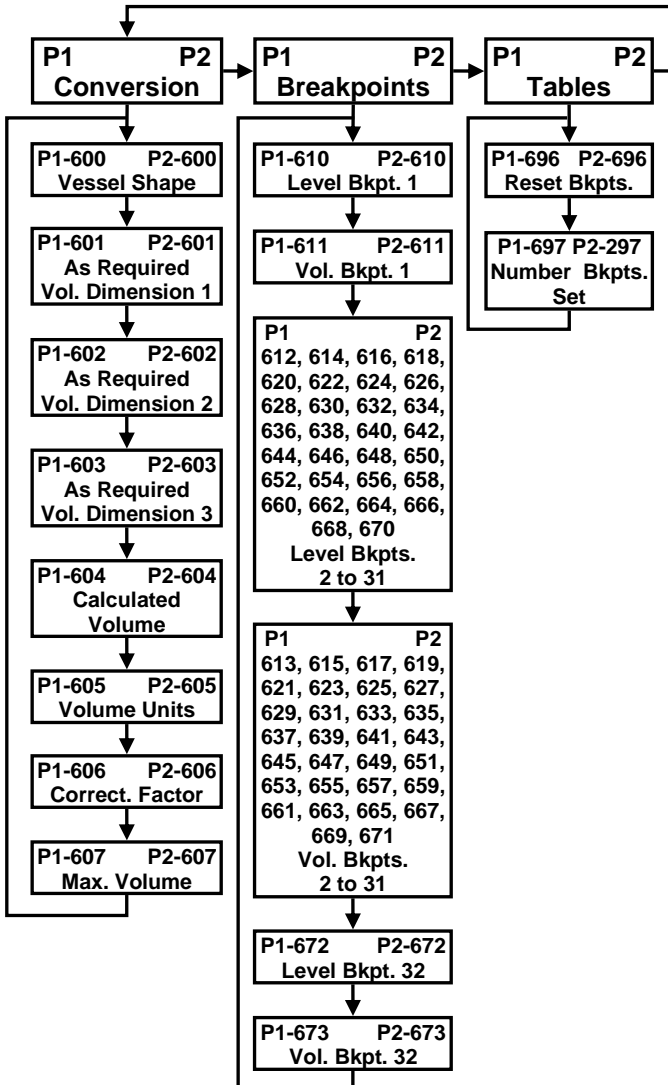



**OCM Menu**

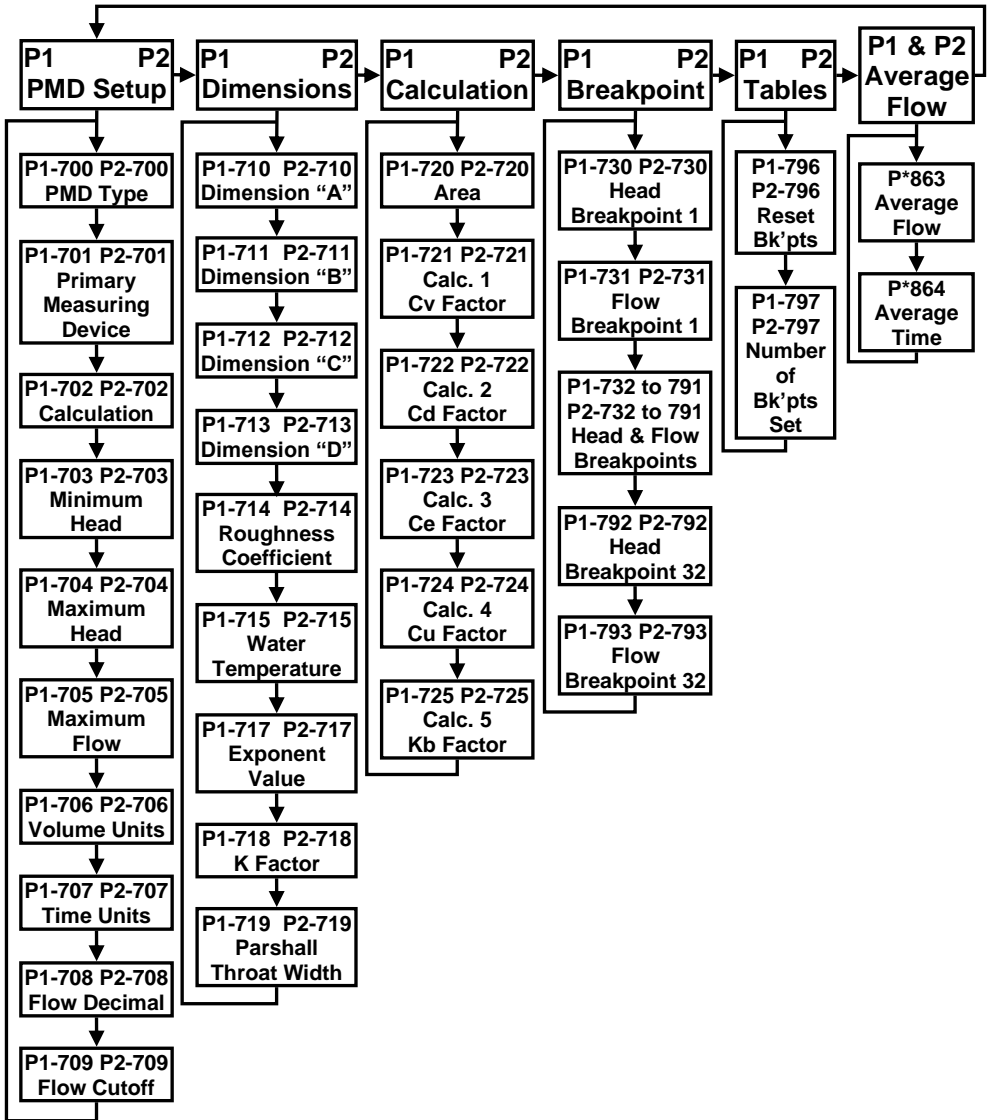

# Display

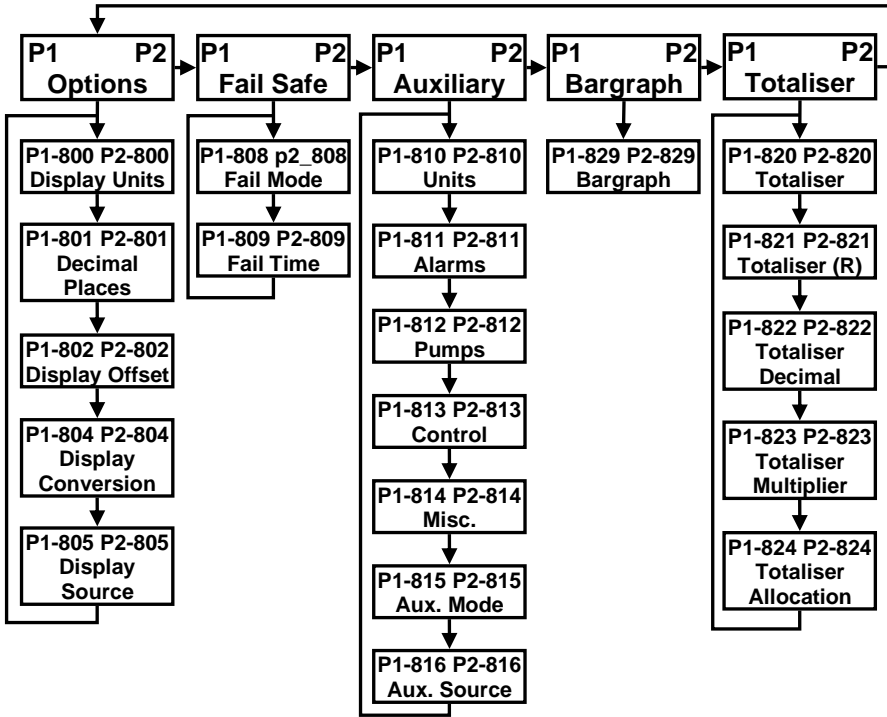

## **mA Output 1 Menu**

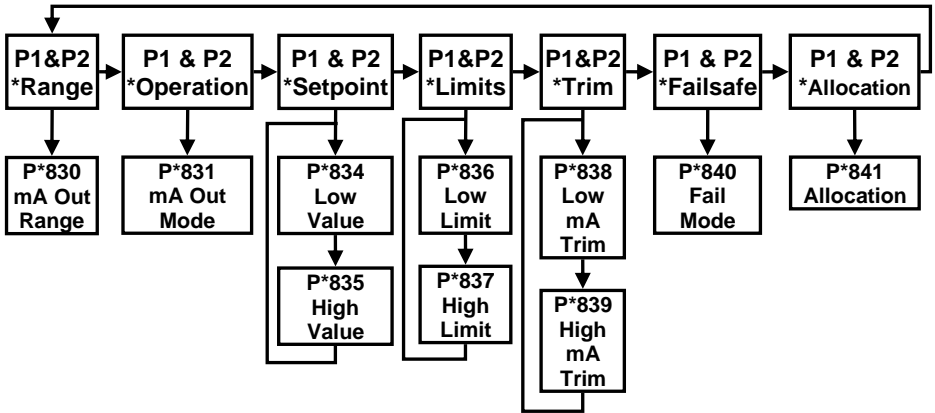

## **mA Output 2 Menu**

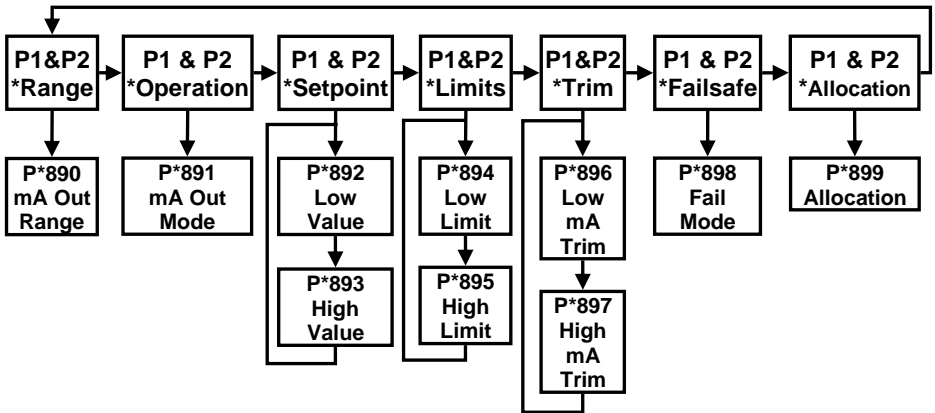

## Compensation

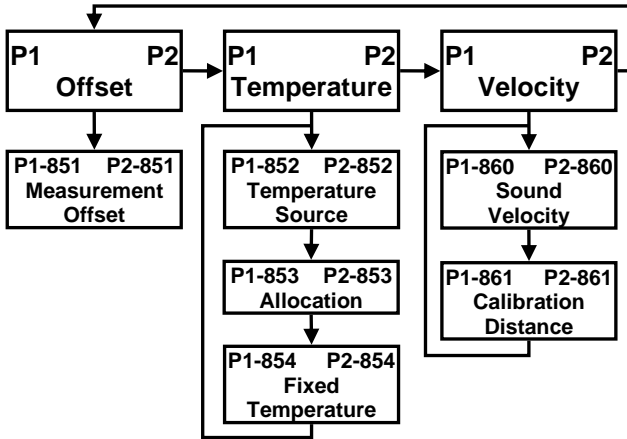

## Stability Menu

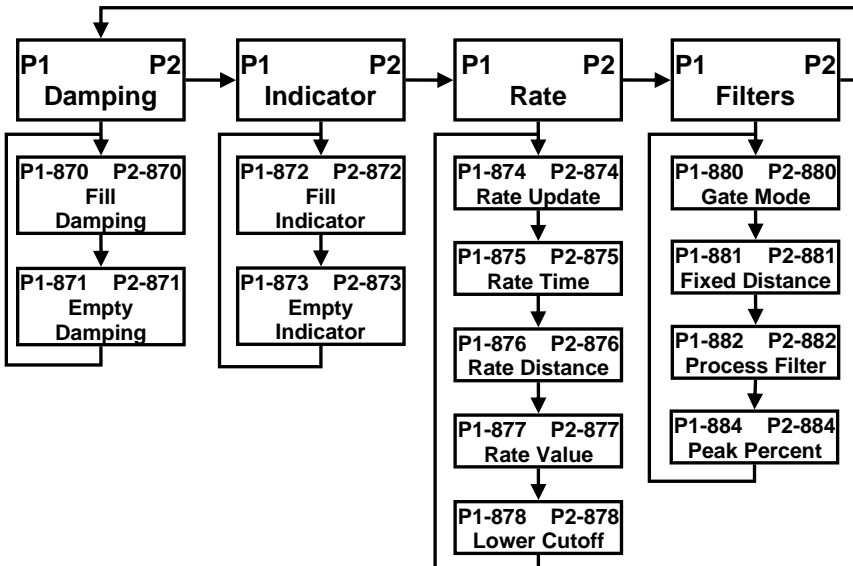

## Echo Processing Menu

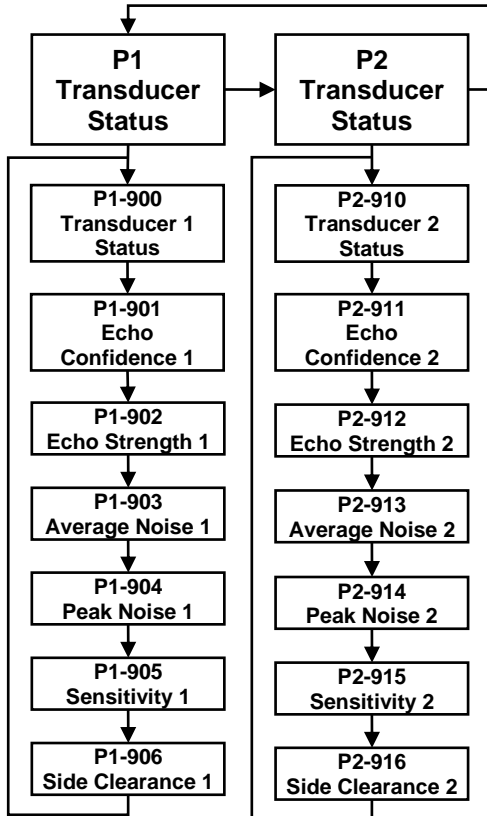

# System Menu

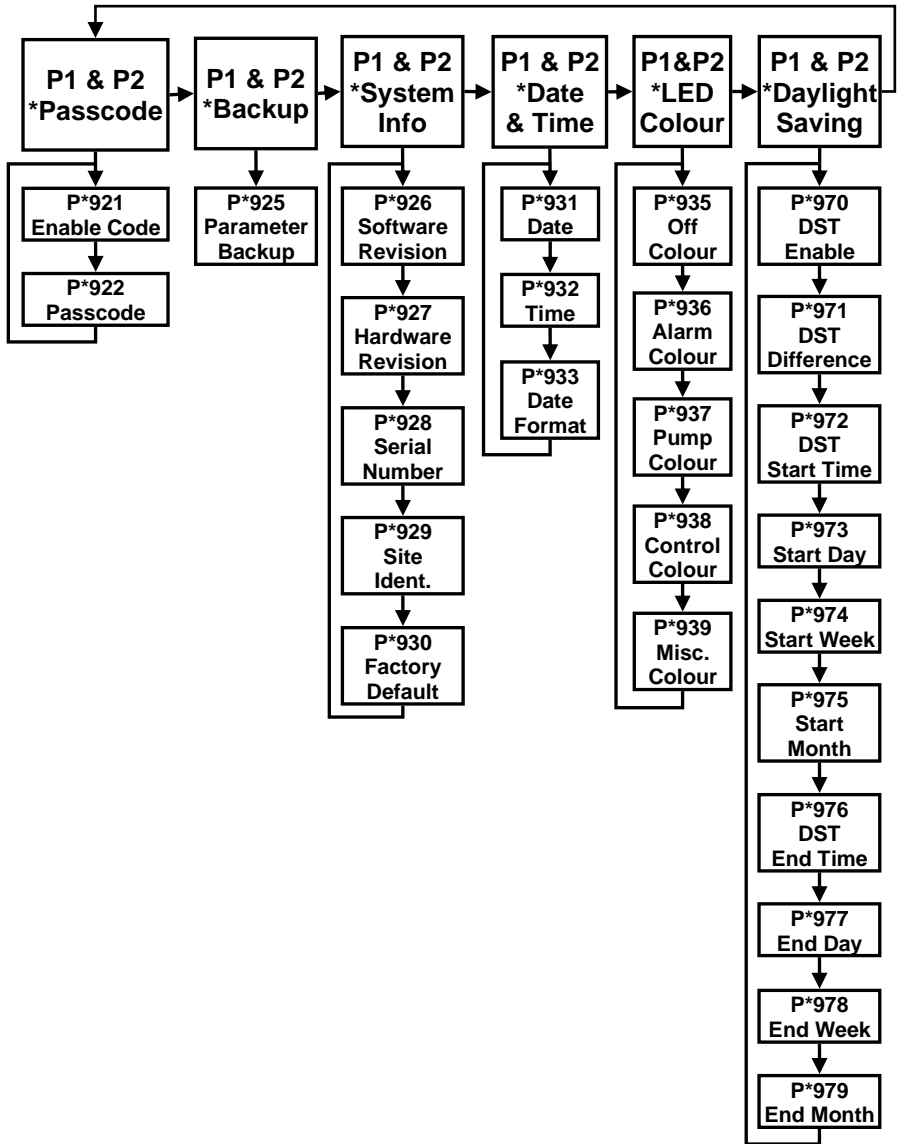

# Device Comm Menu

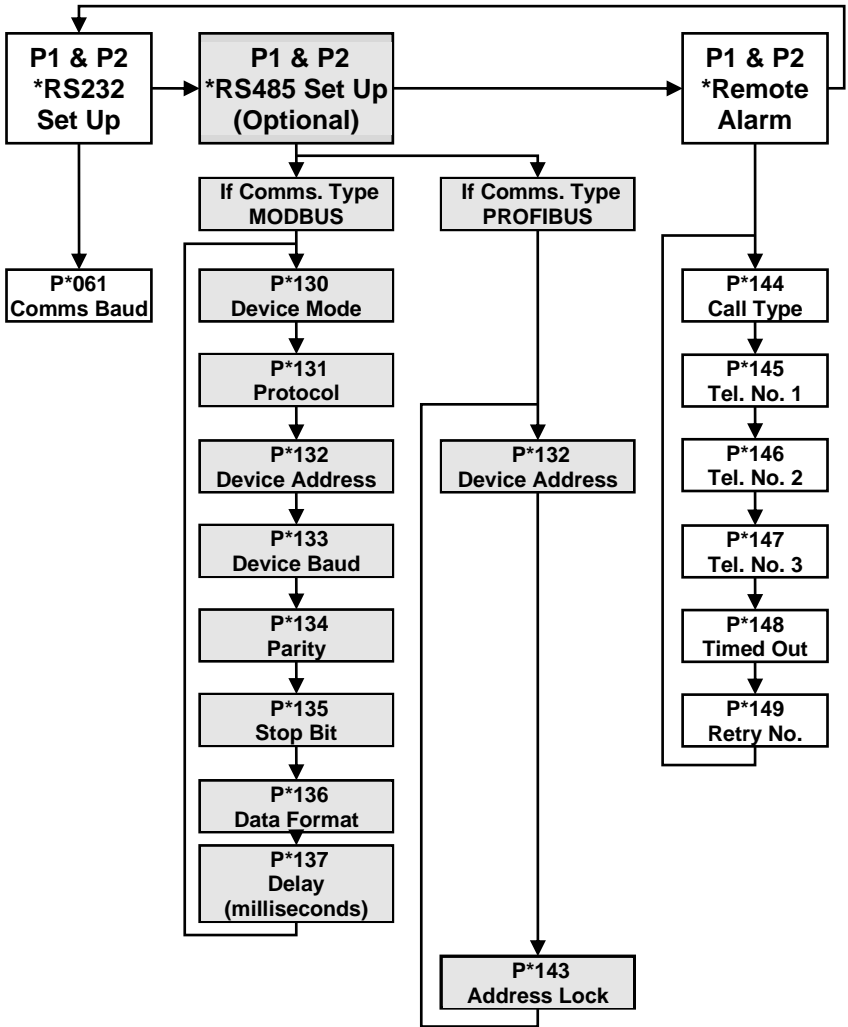

# Test Menu

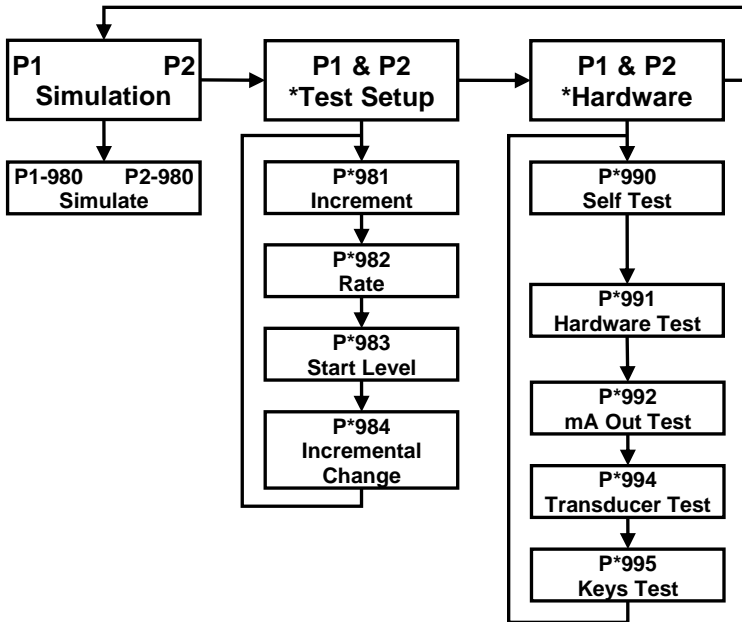



## Application Parameters

### System Units

*P1 and P2*

*P\*104 Measurement Units*

This parameter sets the units you want to use for programming and display

Option	Description
1 = metres	All units of measure are <b>METRES</b>
2 = cm	All units of measure are <b>CENTIMETRES</b>
3 = mm	All units of measure are <b>MILLIMETRES</b>
<b>4 = feet (Default)</b>	All units of measure are <b>FEET</b>
5 = inches	All units of measure are <b>INCHES</b>

### Operation

*P1 or P2*

*P1-100, P2-100 Mode of Operation*

This parameter sets the mode of operation, when in run mode, and can be set to one of the following:

Option	Description
<b>1= Distance (Default)</b>	Display shows the <b>distance</b> from the transducer face to the surface.
2= Level	Display shows how <b>full</b> the vessel is.
3= Space	Display shows how <b>empty</b> a vessel is.
4 = OCM Head	Display shows how high the <b>head</b> is.
5 = OCM Flow	Display shows the instantaneous <b>flow</b> .
6= Volume	Display shows <b>volume</b> of material in the vessel.

### **P1-101, P2-101 Transducer**

This parameter should be set to the transducer being used with the unit, and can be set to one of the following:

<b>Option</b>	<b>Description</b>
<b>When P100 = 1 (Distance), 2 (Level), 3 (Space) or 6 (Volume)</b>	
0=Auxiliary <b>(Optional)</b>	Use the optional mA input (Please consult Pulsar for availability).
1 = dB3	Transducer is a dB3. Range 0.410 to 9.843 feet
<b>2 = dB6 (Default)</b>	Transducer is a dB6. Range 0.984 to 19.685 feet
3= dB10	Transducer is a dB10. Range 0.984 to 32.808 feet
4= dB15	Transducer is a dB15. Range 1.640 to 49.213 feet
5= dB25	Transducer is a dB25. Range 1.969 to 82.021 feet
6 = dB40	Transducer is a dB40. Range 3.937 to 131.234 feet
7 = dBS6	Transducer is a dBS6. Range 0.656 to 19.685 feet
8 = dBMach3	Transducer is a dBMach3 Range 0.0 to 7.956 feet
<b>When P100 = 4 (OCM Head) or 5 (OCM Flow)</b>	
<b>1 = dBMach3 (Default)</b>	Transducer is a dBMach3 Range 0.0 to 7.956 feet
2 = dB6	Transducer is a dB6. Range 0.984 to 19.685
3= dB10	Transducer is a dB10. Range 0.984 to 32.808 feet
4= dB15	Transducer is a dB15. Range 1.640 to 49.213 feet
7 = dBS6	Transducer is a dBS6. Range 0.656 to 19.685 feet
<b>Available for all modes selected in P100</b>	
*9 = dBR16	Transducer is a mmWave Radar. Range 0.252 to 52.49 feet
*10 = dBR8	Transducer is a mmWave Radar. Range 0.252 to 26.25 feet

#### **Important Information**

The choices of transducers available will be dependent on the Mode, (P1-100, P2-100), selected and will vary from application to application.

\* Please consult your local Pulsar distributor for the versions of firmware that the mmWAVE Radars are available in.

### **P1-102, P2-102 Material**

This parameter should be set to the type of material being monitored.

<b>Option</b>	<b>Description</b>
<b>1 = Liquid (Default)</b>	Use for liquids and flat solid materials
2 = Solid	Solid material that is heaped or at an angle

## **Dimensions**

### ***P1 or P2***

#### ***P1-105, P2-105 Empty Level***

This parameter is to be set to the **maximum distance** from the **face** of the transducer to the **empty point**, in **P\*104 Measurement Units**. Note this value affects span as well, (see important information below), so should be set before span.

#### **Important Information**

When using the **dB Mach 3** the **empty distance** is measured from the end of the **horn** to the **empty point** in **P104 Measurement Units**.

#### **Important Information**

When changing the Empty Distance (P1-105, P2-105) you can also recalculate the values for the Span so that it equals the empty distance (P105) minus Near Blanking (P107) and the Relay Setpoints, so that they remain at the same percentage values of the empty distance as they were before you changed the empty distance (P105). You will be asked the question "Recalculate Span?" if you choose YES (enter 1), then the span will be recalculated. Any other answer will leave the span at its original value. You will then be asked if you want to "Recalculate Setpoints?", if you choose YES (enter 1), then all Relay Setpoints will be recalculated as a percentage of the new empty distance. Any other answer will leave the setpoints at their original values.

#### ***P1-106, P2-106 Span***

This parameter should be set to the maximum distance from the **Empty Level (P1-105, P2-105)** to the maximum material level. It is automatically set to be equal to the **Empty Level (P1-105, P2-105)** less the **Near Blanking** distance (**P1-107, P2-107**), when you set the empty level.

### ***P1-107, P2-107 Near Blanking Distance***

This parameter is the distance from the face of the transducer that is not measurable and is pre-set to the minimum value dependant on the Xducer (P101) selected. It should not be set to less than this figure, but can be increased, typical to ignore close in obstructions.

<b>Transducer</b>	<b>Near Blanking Distance</b>
P101 = dB Mach3 Transducer	Default Blanking Distance = 0.000 feet
P101 = dB3 Transducer	Default Blanking Distance = 0.410 feet
P101 = dB6 Transducer	Default Blanking Distance = 0.984 feet
P101 = dB10 Transducer	Default Blanking Distance = 0.984 feet
P101 = dB15 Transducer	Default Blanking Distance = 1.640 feet
P101 = dB25 Transducer	Default Blanking Distance = 1.969 feet
P101 = dB40 Transducer	Default Blanking Distance = 3.937 feet
P101 = dB S6 Transducer	Default Blanking Distance = 0.656 feet
P101 = dB R16 Radar	Default Blanking Distance = *0.252 feet
P101 = dB R8 Radar	Default Blanking Distance = *0.252 feet

\*The signal emanates from the curved face of the Radar, but for the purposes of measurement it is taken from the drip shield.

### ***P108 Far Blanking Distance***

This is the distance (as a **percentage** of **empty level P1-105, P2-105**) beyond the empty point that the unit will be able to measure, and by **default** is pre-set to plus **20%** of the **empty level**.

If the surface being monitored can extend beyond the **Empty Level (P1-105, P2-105)** then the far blanking distance can be increased to a maximum of 100% of empty level.

This parameter is always entered as a % of empty level.

## Relay Parameters

### *P1 and P2*

All relay related parameters are prefixed with a **2\*\***.

The second digit of the three-figure parameter number denotes the relay number as follows:

**21\*** parameters for Relay 1

**22\*** parameters for Relay 2

**23\*** parameters for Relay 3

**24\*** parameters for Relay 4

**25\*** parameters for Relay 5

**26\*** parameters for Relay 6

The third digit selects specific parameters for the setting of the relays, which can be selected individually and results in the following parameter numbers for each relay.

Relay 1 **210** to **219**

Relay 2 **220** to **229**

Relay 3 **230** to **239**

Relay 4 **240** to **249**

Relay 5 **250** to **259**

Relay 6 **260** to **269**

### ***P\*210, P\*220, P\*230, P\*240, P\*250, P\*260 - Relay Type***

This parameter defines what type each relay should be, see the table below for available options, which will be dependent on the Operational **Mode (P100)**, selected.

<b>Option</b>	<b>Description</b>
<b>0= Not In Use (Default)</b>	Relay not in use or programmed and LED will always be off.
1= Alarm	Relay is programmed as an alarm relay, which will <b>de-energise ON</b> , and <b>energise OFF</b> . This will ensure an alarm is raised if the power fails to the unit.
2= Pump	Relay is programmed as a pump relay, which will <b>energise ON</b> , and <b>de-energise OFF</b> .
3= Control	Relay is programmed as a control relay, which will <b>energise ON</b> , and <b>de-energise OFF</b> .
4= Miscellaneous	Relay is programmed as a miscellaneous relay, which will <b>energise ON</b> , and <b>de-energise OFF</b> .

### **Alarms**

#### ***P1 and P2***

When **P\*210, 220, 230, 240, 250, 260 =1 (Alarm)**

The **second parameter** for each relay determines the **function** of the alarm.

#### ***P\*211, P\*221, P\*231, P\*241, P\*251, P\*261 - Relay Function***

This parameter defines what **function** the **alarm** will respond to as follows.

<b>Option</b>	<b>Description</b>
<b>0= Off (Default)</b>	Relay will not operate.
1= Level	Alarm is based on the level in the vessel, and the type of level alarm (P*212, 222, 232, 242, 252, 262) and two setpoints must be set (P*213, 223, 233, 243, 253, 263 & P*214, 224, 234, 244, 254, 264). Setpoints are entered in Display Units or % of span as referenced to Empty Level.

Option	Description
2= Rate of Change	Alarm is based on the rate of change of level in the vessel, and the type of rate of change alarm (P*212, 222, 232, 242, 252, 262) and two setpoints must be set (P*213, 223, 233, 243, 253, 263 & P*214, 224, 234, 244, 254, 264). Setpoints are entered in Display Units per minute or % of span per minute and a negative value should be entered for a Rate Alarm on a de-creasing level, and a positive value for an increasing level.
3= Temperature	Alarm is based on the temperature, and the type of temperature alarm (P*212, 222, 232, 242, 252, 262) and two setpoints must be set (P*213, 223, 233, 243, 253, 263 & P*214, 224, 234, 244, 254,264). The temperature used depends on the temperature source selected (P1-852/P2-852). Setpoints are entered in °C.
4= Loss of Echo	Alarm is raised if the <b>Failsafe Timer (P1-809/P2-809)</b> expires. No setpoints are required.
5= Loss of Clock	Alarm is raised if the real time clock fails. No setpoints are required.
6 = Device Fail	Alarm is raised if a device, connected to the relay assigned in alarm ID (P*212, 222, 232, 242, 252, 262), fails. E.g. pump is put out of service. No setpoints are required.
7 = Device Alarm	Alarm is raised if a fail signal is detected on the digital input as assigned in alarm ID (P*212, 222, 232, 242, 252, 262) No setpoints are required.

Note that the loss of echo and loss of clock will also be shown on the display as “LOST ECHO” and “LOST CLOCK” respectively.

The **third parameter** for each relay determines the **alarm ID** for the relay you wish to set.

**P\*212, P\*222, P\*232, P\*242, P\*252, P\*262 Relay Alarm ID**

**When P\*211, 221, 231, 241, 251, 261 = 1 (Level), 2(Rate of Change) or 3 (Temperature)**

This parameter defines which **alarm type**, or **identification**, the relay should respond to, as follows.

<b>Alarm ID</b>	<b>Description</b>	<b>Setpoints</b>
<b>1=General (Default)</b>	Relay goes “ON” when the value reaches the ON setpoint and goes “OFF” when the value reaches the OFF setpoint.	P*213, 223, 233, 243, 253, 263 is ON Setpoint; P*214, 224, 234, 244, 254, 264 is OFF Setpoint
2= High	Relay goes “ON” when the value rises to the ON setpoint and goes “OFF” when the value lowers to the OFF setpoint.	ON> OFF Relay Setpoints P*213, 223, 233, 243, 253, 263 and P*214, 224, 234, 244, 254, 264 Setpoints, can be set in any order as the unit ‘knows’ that you are setting a high level alarm.
3= Hi-Hi	Same as 2 = High, but different identifier.	
4= Low	Relay goes “ON” when the value lowers to the ON setpoint and goes “OFF” when the value rises to the OFF setpoint.	ON<OFF Relay Setpoints P*213, 223, 233, 243, 253, 263 and P*214, 224, 234, 244, 254, 264. Setpoints, can be set in any order as the unit ‘knows’ that you are setting a low level alarm.
5= LoLo	Same as 4=Lo, but different identifier.	



<b>Alarm ID</b>	<b>Description</b>	<b>Setpoints</b>
6= In bounds	Relay goes “ON” if value is inside the zone between the two setpoints.	Relay Setpoints, P*213, 223, 233, 243, 253, 263 and P*214, 224, 234, 244, 254, 264 can be set in any order as the unit ‘knows’ that you are setting an inbounds alarm.
7= Out of bounds	Relay goes “ON” if value is outside the zone between the two setpoints.	Relay Setpoints P*213, 223, 233, 243, 253, 263 and P*214, 224, 234, 244, 254, 264 can be set in any order as the unit ‘knows’ that you are setting an out of bounds alarm.

When P\*211, 221, 231, 241, 251, 261 = 4 (Loss of Echo) or 5 (Loss of Clock)

The **third parameter** has no function and will not be displayed.

### When P\*211, 221, 231, 241, 251, 261 = 6 (Device Fail)

This parameter defines which **failed device relay**, the **alarm** should respond to, as follows.

<b>Alarm ID</b>	<b>Description</b>	<b>Setpoints</b>
1 = Fail Rel.1	Relay goes “ <b>ON</b> ” when a <b>device failure</b> is detected on <b>relay 1</b> .	None
2 = Fail Rel.2	Relay goes “ <b>ON</b> ” when a <b>device failure</b> is detected on <b>relay 2</b> .	None
3 = Fail Rel.3	Relay goes “ <b>ON</b> ” when a <b>device failure</b> is detected on <b>relay 3</b> .	None
4 = Fail Rel.4	Relay goes “ <b>ON</b> ” when a <b>device failure</b> is detected on <b>relay 4</b> .	None
5 = Fail Rel.5	Relay goes “ <b>ON</b> ” when a <b>device failure</b> is detected on <b>relay 5</b> .	None
6 = Fail Rel.6	Relay goes “ <b>ON</b> ” when a <b>device failure</b> is detected on <b>relay 6</b> .	None
7 = Any 1 Fail	Relay goes “ <b>ON</b> ” when a <b>device failure</b> is detected on <b>any 1 relay</b> .	None
8 = Any 2 Fail	Relay goes “ <b>ON</b> ” when <b>2 device failures</b> are detected on <b>any 2 relays</b> .	None

**When P\*211, 221, 231, 241, 251, 261 = 7 (Device Alarm)**

This parameter defines which **digital input**, the **alarm** should respond to, as follows.

<b>Alarm ID</b>	<b>Description</b>	<b>Setpoints</b>
1 = Fail Inp.1	Relay goes “ <b>ON</b> ” when a <b>fail signal</b> is detected on <b>digital input 1</b> .	None
2 = Fail Inp.2	Relay goes “ <b>ON</b> ” when a <b>fail signal</b> is detected on <b>digital input 2</b> .	None
3 = Fail Inp.3	Relay goes “ <b>ON</b> ” when a <b>fail signal</b> is detected on <b>digital input 3</b> .	None
4 = Fail Inp.4	Relay goes “ <b>ON</b> ” when a <b>fail signal</b> is detected on <b>digital input 4</b> .	None
5 = Fail Inp.5 (Wall mount Only)	Relay goes “ <b>ON</b> ” when a <b>fail signal</b> is detected on <b>digital input 5</b> .	None
6 = Fail Inp.6 (Wall mount Only)	Relay goes “ <b>ON</b> ” when a <b>fail signal</b> is detected on <b>digital input 6</b> .	None
7 = Fail Inp.7 (Wall mount Only)	Relay goes “ <b>ON</b> ” when a <b>fail signal</b> is detected on <b>digital input 7</b> .	None

The **fourth parameter** and the **fifth parameter** for each relay set the Alarm “ON” and “OFF” points. For a *high alarm* the “ON” is set **higher than** “OFF”. For *low alarm* then “ON” is set **lower than** “OFF”. See the appropriate **alarm ID**, table (P\*212, 222, 232, 242, 252, 262) for further information.

When P\*211, 221, 231, 241, 251, 261 = 1 (Level), 2 (Rate of Change) or 3 (Temp.)

**P\*213, P\*223, P\*233 P\*243, P\*253, P\*263 - Relay Setpoint 1**

Determines the “ON” or “OFF” point for the alarm according to the **ID** selected.

**P\*214, P\*224, P\*234, P\*244, P\*254, P\*264 - Relay Setpoint 2**

Determines the “ON” or “OFF” point for the alarm according to the **ID** selected.

**Important Information**

**Setpoints** are entered in values according to the **function** selected.

**Level** - entered in Display Units or % of span as referenced to Empty Level.

**Rate of Change** - entered in Display Units per minute or % of span per minute. For an alarm on a increasing level enter setpoints as a positive value, for an alarm on a decreasing level enter setpoints as a negative value.

**Temperature** - entered in °C.

**Efficiency** – entered in % value of efficiency.

See the appropriate **alarm function**, table (P211, 221, 231, 241, 251, 261) for further information.

- To set **level** setpoints in % press the  hot key to show and enter % figure relative to empty level.

When P\*211, 221, 231, 241, 251, 261 = 4 (Loss of Echo), 5 (Loss of Clock), 6 (Device Fail) or 7 (Device Alarm)

The **fourth** and **fifth parameters** have no function and will not be displayed.

The next parameter will determine which point(s) of measurement that the alarm relay is to be **allocated** to.

**P\*216, P\*226, P\*236, P\*246, P\*256, P\*266 - Relay Allocation**

**When P\*211, 221, 231, 241, 251, 261 = 1 (Level)**

This parameter determines which point(s) of measurement the relay will react to.

<b>Option</b>	<b>Description</b>
<b>1= Point 1 (Default)</b>	Relay acts on <b>Point 1</b> calculated levels.
2= Point 2	Relay acts on <b>Point 2</b> calculated levels.
3= Avg. 1 & 2	Relay acts on calculated <b>average level</b> of <b>1 &amp; 2</b> .
4= Sum 1 + 2	Relay acts on calculated <b>sum level</b> of <b>1 &amp; 2</b> .
5= Diff. 1 - 2	Relay acts on calculated <b>differential level</b> of <b>1 - 2</b>

**When P\*211, 221, 231, 241, 251, 261 = 2 (Rate of Change), 3 (Temperature) or 4 (Loss of Echo)**

<b>Option</b>	<b>Description</b>
<b>1= Point 1 (Default)</b>	Relay acts on <b>Point 1</b> calculated values.
2= Point 2	Relay acts on <b>Point 2</b> calculated values.

**When P\*211, 221, 231, 241, 251, 261 = 5 (Loss of Clock), 6 (Device Fail) or 7 (Device Alarm)**

This parameter has no function and will not be displayed.

## **Pumps**

### ***P1 and P2***

This option is not available when **Mode (P100)** is set to **6 = Volume**.

### **When P\*210, 220, 230, 240, 250, 260 = 2 (Pump)**

When a relay is being used for a **pump** function, the **second parameter** determines the **pump duty** that will be used to determine the operating cycle.

### ***P\*211, P\*221, P\*231, P\*241, P\*251, P\*261 - Relay Function,***

This parameter defines which **pump duty** the relay should respond to as follows.

<b>Pump Duty</b>	<b>Description</b>
<b>0= Off (Default)</b>	Relay is always de-energised.
1= Fixed duty assist	All pumps are used to assist each other (run at the same time) and each pump has its own setpoints. (P*213, 223, 233, 243, 253, 263 & P*214, 224, 234, 244, 254, 264).
2= Fixed duty backup	If a pump fails to meet the demand (due to malfunction, intake blockage etc.), then it is stopped and another pump shall take over. Each pump has its own setpoints. (P*213, 223, 233, 243, 253, 263 & P*214, 224, 234, 244, 254, 264).
3= Alternate duty assist	All pumps are used to assist each other (run at the same time). Each pump has its own setpoints, (P*213, 223, 233, 243, 253, 263 & P*214, 224, 234, 244, 254, 264) but each time all pumps have stopped, the setpoints are sequentially rotated between the pumps to ensure equal pump use.

<b>Pump Duty</b>	<b>Description</b>
4= Alternate duty backup	If a pump fails to meet the demand (due to malfunction, intake blockage etc.), then it is stopped and another pump shall take over. Each pump has its own setpoints, (P*213, 223, 233, 243, 253, 263 & P*214, 224, 234, 244, 254, 264) but each time all pumps have stopped, then the setpoints are sequentially rotated between the pumps to ensure equal pump use.
5= Duty backup and assist	First pump comes on, if it cannot cope, it goes off and next pump comes on (duty backup). This continues until the last pump comes on and if it cannot cope the first pump comes back on to assist the last pump (duty assist) if the level continues to rise all other pumps will come on (assist) in turn until the level decreases to the pump off points. Each pump has its own setpoints, (P*213, 223, 233, 243, 253, 263 & P*214, 224, 234, 244, 254, 264).
6= Service ratio duty assist	All pumps are used to assist each other (run at the same time) and each pump has its own setpoints (P*213, 223, 233, 243, 253, 263 & P*214, 224, 234, 244, 254, 264). And a service ratio setting. The third setpoint (P*215, 225, 235, 245, 255, 265) is used to set the service ratio. Each time a pump is required to start then the pump with the least running hours (with respect to the service ratio) is started (i.e. the setpoints are re-assigned accordingly). For example, if two pumps A and B have the service ratio set to 2 and 1 respectively, then pump A will operate for twice as many hours as pump B.

<b>Pump Duty</b>	<b>Description</b>
7= Service ratio duty backup	If a pump fails to meet the demand (due to malfunction, intake blockage and so on), then it is stopped and another pump shall take over. Each time a pump is required to start then the pump with the least running hours (with respect to the service ratio) is started (i.e. the setpoints are re-assigned accordingly). Each pump has its own setpoints (P*213, 223, 233, 243, 253, 263 & P*214, 224, 234, 244, 254, 264). The third setpoint (P*215, 225, 235, 245, 255, 265) is used to set the service ratio. For example, if two pumps A and B have the service ratio set to 2 and 1 respectively, then pump A will operate for twice as many hours as pump B.
8= <b>First On First Off</b> , alternate duty assist	The first pump switched on is the first pump to be switched off, etc. regardless of the set points, so the setpoints are dynamically changed to enable this.
9 = Service Ratio Standby	When a service ratio duty is being used, on all other pumps in use, the standby pump can be started on a ratio basis only, when it will assume the setpoints of the next pump to start. The third setpoint (P*215, 225, 235, 245, 255, 265) is used to set the service ratio.
10 = Two Pump Sets	There are four pumps. Two rotate their start-up sequence with each other. If the two pumps cannot keep up, the level rise to the setpoints of the other two pumps which take over and rotate their sequence with each other.

### **Important Information**

The pumps are started and stopped at the “ON” and “OFF” setpoints. To *pump down* (reduce level) then set “ON” higher than “OFF”. To *pump up* (increase level) then set “ON” lower than “OFF”.



The **third parameter** for each relay determines the pump group. You can have two groups of pumps, and all similar duties within that group will operate together.

***P\*212, P\*222, P\*232, P\*242, P\*252, P\*262 - Relay Pump Group***

By **default**, all pump groups are set to **1**, but if you want to have another group, then set this parameter to **2**, for each pump relay that should operate together as part of a second group on the same point of measurement.

The **fourth parameter** and the **fifth parameter** for each relay set the **pump “ON”** and **“OFF”** points, which are entered in **Measurement units P\*104**. For *pump down* the **“ON”** is set **higher than “OFF”**. For *pump up* then **“ON”** is set **lower than “OFF”**. See the appropriate **pump duty**, function table (**P\*212, 222, 232, 242, 252, 262**) for further information.

***P\*213, P\*223, P\*233, P\*243, P\*253, P\*263 - Relay Setpoint 1***

This parameter determines the **“ON”** point of the pump.

***P\*214, P\*224, P\*234, P\*244, P\*254, P\*264 - Relay Setpoint 2***

This parameter determines the **“OFF”** point for the pump.

The **sixth parameter** will determine the **service ratio** that will be used to switch the pump, when the **pump duty** selected is a **Service Ratio** duty.

**When P\*211, 221, 231, 241, 251, 261 = 6, 7 or 9 (Service ratio)**

***P\*215, P\*225, P\*235, P\*245, P\*255, P\*266 - Relay Setpoint 3***

This parameter determines the Service Ratio in values of %. See the appropriate **pump duty** function, table (**P\*211, 221, 231, 241, 251, 261**), for further information.

***P\*216, P\*226, P\*236, P\*246, P\*256, P\*266 - Relay Allocation***

This parameter determines which point of measurement the relay will react to.

<b>Option</b>	<b>Description</b>
<b>1= Point 1 (Default)</b>	Relay acts on <b>Point 1</b> calculated levels.
<b>2= Point 2</b>	Relay acts on <b>Point 2</b> calculated levels.

**P\*219, P\*229, P\*239, P\*249, P\*259, P\*269 - Relay Max.Rate**

This parameter will allow a **pump** to be **switched** at a pre-determined **Rate of change of Level**, irrespective of the “ON” level setpoint P\*213, 223, 233, 243, 253, 263. Once a General Control relay has been switched “ON” by the pre-determined **Rate of Change**, it will remain energised until the level reaches the “OFF” level setpoint **P\*214, 224, 234, 244, 254, 264**.

Max. Rate is entered in Measurement Units (P\*104) per minute and can be entered as either positive (increasing level) or negative (decreasing level) values.

**Control**

***P1 and P2***

**When P\*210, 220, 230, 240, 250, 260 = 3 (Control)**

When a relay is being set up as a **control** relay, the **second parameter** that will be displayed in the menu determines its **function**.

***P\*211, P\*221, P\*231, P\*241, P\*251, P\*261 Relay Function,***

This function allows the relay to be assigned to specific **control** functions (other than pumps and alarms) several of these functions work in relation to time.

This can be used to activate devices based on elapsed time or running cycles, such as a timed rake control to keep a ram lubricated if idle for long periods, or flush valve operation.

<b>Options</b>	<b>Description</b>
0 = Off	Relay is always de-energised
1 = Time	Relay will <b>energise</b> “ON” after the <b>Cycle time</b> that is set in Relay <b>Setpoint 2</b> (P*214, 224, 234, 244, 254, 264). And turns “OFF”, <b>de-energises</b> , after the <b>On Time Period</b> that is set in Relay <b>Setpoint 1</b> (P*213, 223, 233, 243, 253, 263)

Options	Description
2=Step Time	<p>Step Time Control allows relays to be used to control a device, such as a motorised valve or gate, in order to maintain the level within two predetermined points. Relays will <b>energise “ON”</b> when Step Time condition is in effect and <b>de-energises “OFF”</b> when Step Time goes off. One relay will be required to control an increase in level, (‘open’ the device) and a second relay is required to control a decrease in level, (‘close’ the device). <b>Alarm ID</b> (P*212, 222, 232, 242, 252, 262) is used to assign the relay to control either the <b>open</b> or <b>close</b> condition. Step Time Control relay requires three setpoints. The first set point (P*213, 223, 233, 243, 253, 263) determines the <b>level</b>, at which the relay is to be activated, (N.B. level setpoint for <b>open</b> relay, <b>increase</b> the level, must be <b>lower than</b> the setpoint for the <b>close</b> relay, <b>decrease</b> the level). The relay will <b>energise “ON”</b> after the <b>Limit time</b> that is set in Relay <b>Setpoint 3</b> (P*215, 225, 235, 245, 255, 265). And turns <b>“OFF”</b>, <b>de-energises</b>, after the <b>Drive Period</b> that is set in Relay <b>Setpoint 2</b> (P*214, 224, 234, 244, 254, 264).</p>
3 = General Control	<p>Control is based on the level in the vessel. All general controls are used to assist each other (run at the same time) and each general control relay has its own <b>“ON”</b> and <b>“OFF”</b> setpoints. Two setpoints are required, <b>“ON”</b> (P*213, 223, 233, 243, 253, 263) and <b>“OFF”</b> (P*214, 224, 234, 244, 254, 264).</p>

### Important Information

General Control relays are started and stopped at the “ON” and “OFF” setpoints. To *control down* (reduce level) then set “ON” higher than “OFF”. To *control up* (increase level) then set “ON” lower than “OFF”.

The **third parameter** for each relay determines the **assignment** or **condition** of the relay, where required.

**P\*212, P\*222, P\*232, P\*242, P\*252, P\*262 Relay Alarm ID/Pump Group,**

**When P\*211, 221, 231, 241, 251, 261 = 1 (Time), or 3 (General Control)**

This parameter has no function and will not be displayed.

**When P\*211, 221, 231, 241, 251, 261 = 2 (Step Time)**

If the relay is selected for Step Time, then this parameter is used to assign the relay to the **0 = Open** condition (increase level) or **1 = Close** condition (decrease level).

The **fourth parameter, fifth parameter** and **sixth parameter** are set to determine the switch points, “**ON**” and “**OFF**” for the relay and where required the order of start. See **control function**, table (**P\*211, 221, 231, 241, 251, 261**) for further information.

**When P\*211, 221, 231, 241, 251, 261 =1 (Time)**

**P\*213, P\*223, P\*233, P\*243, P\*253, P\*263 Relay Setpoint 1**

This parameter determines the “**Time Period**” that the relay will remain “**ON**”.

Relay Setpoints are entered in Minutes.

See the appropriate relay **Function** tables (**P\*211, 221, 231, 241, 251, 261**) for further information.

**P\*214, P\*224, P\*234, P\*244, P\*254, P\*264 Relay Setpoint 2**

This parameter determines the “**Cycle Time**” for the operation of the relay.

See the appropriate relay **Function** tables (**P\*211, 221, 231, 241, 251, 261**) for further information.

**When P\*211, 221, 231, 241, 251, 261 = 2 (Step Time)**

***P\*213, P\*223, P\*233, P\*243, P\*253, P\*263 Relay Setpoint 1***

This parameter will determine the “level” at which the relay will become active. Relay Setpoint 1 is entered in values of **Measurement Units (P\*104)**

See the appropriate relay function tables (**P\*211, 221, 231, 241, 251, 261**) for further information.

***P\*214, P\*224, P\*234, P\*244, P\*254, P\*264 Relay Setpoint 2***

Relay Setpoints are entered in Seconds to set **Drive Period**, the time that the relay will remain **ON**

See the appropriate relay **Function** tables (**P\*211, 221, 231, 241, 251, 261**) for further information.

***P\*215, P\*225, P\*235, P\*245, P\*255, P\*265 Relay Setpoint 3***

This parameter is used to determine the **Limit Time** between each Drive Period. Relay Setpoints are entered in Minutes, during which time the relay will remain **OFF**.

See the appropriate relay **Function** tables (**P\*211, 221, 231, 241, 251, 261**) for further information.

**When P\*211, 221, 231, 241, 251, 261 = 3 (General Control)**

***P\*213, P\*223, P\*233, P\*243, P\*253, P\*263 Relay Setpoint 1***

This parameter determines the “ON” point of the relay.

Relay Setpoint 1 is entered in values of **Measurement Units (P104)**

See the appropriate relay function tables (**P\*211, 221, 231, 241, 251, 261**) for further information.

***P\*214, P\*224, P\*234, P\*244, P\*254, P\*264 Relay Setpoint 2***

This parameter determines the “OFF” point of the relay.

Relay Setpoints are entered in values of **Measurement Units (P\*104)**

See the appropriate relay **Function** tables (**P2\*11, 221, 231, 241, 251, 261**) for further information.

**P\*216, P\*226, P\*236, P\*246, P\*256, P\*266 - Relay Allocation**

**When P\*211, 221, 231, 241, 251, 261 = 1 (Time)**

This parameter has no function and will not be displayed.

**When P\*211, 221, 231, 241, 251, 261 = 2 (Step Time)**

<b>Option</b>	<b>Description</b>
<b>1= Point 1 (Default)</b>	Relay acts on <b>Point 1</b> calculated levels.
2= Point 2	Relay acts on <b>Point 2</b> calculated levels.

**When P\*211, 221, 231, 241, 251, 261 = 3 (General Control)**

This parameter determines which point(s) of measurement the relay will react to.

<b>Option</b>	<b>Description</b>
<b>1= Point 1 (Default)</b>	Relay acts on <b>Point 1</b> calculated levels.
2= Point 2	Relay acts on <b>Point 2</b> calculated levels.
3= Avg. 1 & 2	Relay acts on calculated <b>average level</b> of <b>1 &amp; 2</b> .
4= Sum 1 + 2	Relay acts on calculated <b>sum level</b> of <b>1 &amp; 2</b> .
5= Diff. 1 - 2	Relay acts on calculated <b>differential level</b> of <b>1 - 2</b>

## **Miscellaneous**

### ***P1 and P2***

**When P\*210, 220, 230, 240, 250, 260 = 4 (Miscellaneous)**

When a relay is set to be a **miscellaneous relay**, the **second parameter** determines its **function**.

### ***P\*211, P\*221, P\*231, P\*241, P\*251, P\*261 - Relay Function,***

This function allows the relay to work in relation to a clock or a specific event and will be set to activate in relation to Real Time.

<b>Options</b>	<b>Description</b>
<b>0 = Off (Default)</b>	<b>Relay Off de-energised</b>
1 = Clock	Relay will <b>energise ON</b> at a specified time each day as set in Relay Setpoint 1 (P*213, 223, 233, 243, 253, 263). And turns <b>OFF, de-energises</b> , after the specified On Time period as set in Relay Setpoint 2 (P*214, 224, 234, 244, 254, 264)
2 = Totaliser  Only when <b>Mode (P100)</b> is set: <b>4 = (OCM Head)</b> or <b>5 = (OCM Flow)</b>	Relay will energise ON momentarily each time the specified flow has passed as set in Relay setpoint 1 (P*213, 223, 233, 243, 253, 263) this parameter sets the multiplication factor which will be applied to the on board totaliser (P1-820/P2-820) to determine the switch point of the relay. E.g. if the totaliser is set to totalise in cubic metres and the relay is required to provide a closure every 10,000 litres Relay setpoint 1 would be set to 10. Relay setpoint 2 (P*214, 224, 234, 244, 254, 264) is used to select the time the relay will remain closed in seconds.

### **Important Information**

When using a Relay to control a device at a specified time of day ensure that the **Time P\*932** is set correctly. And if required, enable **Daylight Saving** for the appropriate time difference **P\*970 – P\*979**.

The **third parameter** has **no function** when **miscellaneous relay** is chosen and will not be displayed.

The **fourth parameter**, and **fifth parameter**, are set to determine the switch points, “ON” and “OFF” for the relay. See **miscellaneous** function table (P\*211, 221, 231, 241, 251, 261) for further information.

**When P\*211, 221, 231, 241, 251, 261 = 1 (Clock)**

**P\*213, P\*223, P\*233, P\*243, P\*253, P\*263 - Relay Setpoint 1**

Relay Setpoints are entered in Hours & Minutes (HH:MM) to set Time at which relay will energise. **Default = 00:00 (HH:MM)**

**P\*214, P\*224, P\*234, P\*244, P\*254, P\*264 - Relay Setpoint 2**

Relay Setpoints are entered in Minutes to set Time Period that the relay will remain ON. **Default = 0.00 mins.**

**When P\*211, 221, 231, 241, 251, 261 = 2 (Totaliser)**

**P\*213, P\*223, P\*233, P\*243, P\*253, P\*263 - Relay Setpoint 1**

Relay Setpoints are entered as a factor by which the on board totaliser (P1-820/P2-820) should be multiplied by to provide a relay closure. **Default = 0.00**

**P\*214, P\*224, P\*234, P\*244, P\*254, P\*264 - Relay Setpoint 2**

Relay Setpoints are entered in **seconds** to set the **time period** that the relay will remain ‘ON’. **Default = 0.00 secs.**

**P\*216, P\*226, P\*236, P\*246, P\*256, P\*266 - Relay Allocation**

**When P\*211, 221, 231, 241, 251, 261 = 1 (Clock)**

This parameter has no function and will not be displayed.

**When P\*211, 221, 231, 241, 251, 261 = 2 (Totaliser)**

This parameter determines which **totaliser** the **relay** is assigned to.

<b>Option</b>	<b>Description</b>
<b>1= Totaliser 1 (Default)</b>	Relay acts on <b>Totaliser 1</b> calculated <b>values</b> .
<b>2= Totaliser 2</b>	Relay acts on <b>Totaliser 2</b> calculated <b>values</b> .



## **Common Parameters**

### ***P1 and P2***

#### ***P\*217, P\*227, P\*237, P\*247, P\*257, P\*267 - Relay Closures***

This parameter will record how many times each relay is operated, this parameter displays the number of times the relay has activated since the relay has been in use. It can be reset with any value.

#### ***P\*218, P\*228, P\*238, P\*248, P\*258, P\*268 - Relay Fail Safe***

Your *Ultra Twin* has a general fail-safe for each point of measurement, parameter **P1-808** or **P2-808**. However, this can be overridden so that each individual relay has its own independent fail safe mode.

This parameter determines what the relay will do in the event of the **Failsafe Time (P1-809 or P2-809)** expiring.

Option	Description
<b>0 = Default</b>	Relay assumes system default mode P808
1 = Hold	Relay remains in its current state
2 = De-Energise	Relay will De-Energise
3 = Energise	Relay will Energise

## **Pump “Advanced” Parameters**

The following parameters are used to set the “Advanced” Pump features.

### **Pump Run On**

#### ***P1 and P2***

This feature is used to periodically allow the pumps to continue operating below their normal “OFF” point, in order to discharge any sediment that may have settled at the bottom of the vessel.

#### ***P\*349 Prime Level***

Sets the required level to ensure pumps are fully primed after a pump run on has occurred. Following a pump run on, any pump, whose “ON” point is below the Prime Level will be held “OFF” until the Prime Level has been exceeded.

#### ***P\*350 Run Interval***

Set required time period, in hours, at which pump run on should occur.

#### ***P\*351 Run Duration***

This parameter sets the length of time, in seconds, that pumps will run on for, it should be noted that only one run on is allowed per Run Interval.

### **Starting**

#### ***P1 and P2***

This feature is used to reduce the effects of power surges, caused by switching of pumps, in the following instances, **(P352) Power surge** (mains or hydraulic) that is generated when multiple pumps are started simultaneously, **(P353) Power resumption** following a power failure.

#### ***P\*352 Start Delay***

Set the required time period, in seconds, that should elapse between pumps starting. **Default = 10 seconds.**

#### ***P\*353 Power Delay***

Set the required time period, in seconds, that should elapse before pumps are allowed to start following a power failure. **Default = 10 seconds.**

## **Stopping**

### ***P1 and P2***

If required, this feature will **prevent** pumps, with a **common “OFF” point** being switched off all at the same time pumps will be switched “OFF” in turn as determined by the **delay** set in **P348 Stop Delay**.

### ***P\*348 Stop Delay***

Set the required time period, in seconds, that should elapse between pumps stopping. **Default = 0.0 seconds**.

## **Pump Exercising**

### ***P1 and P2***

This feature is used to reduce idle pump corrosion and sediment build up. Pumps are allowed to run after a specified **Idle Time (P355)** for a determined period of **Exercise time (P356)**, providing a **Minimum head /level (P357)** is present and all other pumps are switched off.

### ***P\*354 Exercise Enable***

This parameter determines if Pump Exercising is enabled or disabled.

Option	Description
<b>0 = No (Default)</b>	Pump Exercising disabled
<b>1 = Yes</b>	Pump Exercising enabled

### ***P\*355 Idle Time***

Sets the Idle Time to elapse before Pump Exercising is to be activated.

Set the required time period in minutes. **Default = 720 minutes**

### ***P\*356 Exercise Time***

Set the required Exercise Time in seconds. **Default = 30 seconds**

### ***P\*357 Minimum Head***

To prevent the dry running and the possibility of cavitation, of the pump, enter the minimum level (head) of material, in **measurement units (P\*104)**, that is to be present before permitting pump exercising to take place.

## **Wall Cling**

### ***P1 and P2***

To reduce material build up, (such as fat), on the wall of the sump or vessel, at the “normal” material level the pump setpoints can be varied within a specified band.

For Pump Down applications the relay setpoints for the pumps will be randomly varied within the band specified, somewhere below ON, but to a maximum of the setting, and somewhere higher than OFF, but to a maximum of the setting.

For Pump Up applications the relay setpoints for the pumps will be randomly varied within the band specified somewhere higher than ON, but to a maximum of the setting, and somewhere lower than OFF, but to a maximum of the setting.

### ***P\*360 Wall Cling***

Enter the maximum band, of variation, required in **measurement units (P\*104)**.

## Digital Inputs

### About Digital Inputs

The digital inputs are used to provide the Twin with information on the operational status and condition of pumps, valves, and other process control devices. Based on the information supplied, by the inputs, the Twin, will make intelligent decisions and modify its control regime to meet the demand of the prevailing operational requirements.

The parameters used to program the Digital inputs are as follows:

#### **Common Parameters P\*300 to P\*306**

**Digital Input 1 P\*372 to 374      Digital Input 2 P\*375 to 377**

**Digital Input 3 P\*378 to 380      Digital Input 4 P\*381 to 383**

**Digital Input 5 P\*384 to 386      Digital Input 6 P\*387 to 389**

#### **Digital Input 7 P\*390 to 392**

##### **Important Information**

The Twin provides 4 Digital Inputs on the Wall mount model and seven on the Fascia model.

### Common Parameters Set-up

These parameters determine specific operational criteria for particular digital input functions and are common to each digital input.

### Input Type

The digital inputs can be either voltage source, where Twin will supply the switching voltage, or voltage synch, where the switching voltage is supplied by the input from the device, for full details see **Chapter 2 Installation**. Both voltage source and voltage synch. inputs can be configured for **N.O.** or **N.C.** operation as determined by the digital input **Type P\*372, 375, 378, 381, 384, 387, 390** when set to **1= Input N.C.**, Twin will recognise a **closed** condition, D.C. **signal** voltage **present** at input, as a healthy condition, alternatively, an **open** condition, D.C. **signal** voltage **not present** at input, indicating a healthy condition, can be chosen as a valid input by selecting **2=Input N.O.**

## **Input Function**

Individual inputs can be configured for any one of a number of **Functions** as determined by **P\*373, 376, 379, 382, 385, 388, 391** these functions are as follows:

- 1 = Device Fail** input will provide a signal indicating a “failure” or the presence of a “run” signal from the device. When using digital inputs to detect a “run” condition the input is assumed to be in its operational status until the expiry of **P\*304 Input Delay** which is used to determine the delay time that occurs from the time that the device is called to “run” and the digital input providing a signal appropriate to its operational status.
- 2 = Duty** input will provide a signal to manually select the lead device.
- 3 = Override ON** input will provide a signal to override all selected pump setpoints “ON”.
- 4 = Override OFF** input will provide a signal to override all selected pump setpoints “OFF”.
- 5 = Reset** input will provide a signal to reset all Device Fail signals.
- 6 = Inhibit Meas.** Input will provide a signal to inhibit the measurement of the point it is allocated too.

## **Device Fail**

The digital inputs are used to indicate a ‘fail’ situation which effect devices, which are connected to the relay outputs of the Twin, e.g. failure of a pump, screen, valve, etc. This information is then used to initiate changes to the Twins control regime to meet the demands of the situation.

Let us consider the example of an application using 2 pumps, each pump has the capability to provide a signal indicating its ‘run’ status. Each pump is connected and controlled by one of the Twin relay outputs, the duty and setpoints have been programmed as detailed in **Using the Relays**, earlier in this chapter. The signals providing details on the pumps ‘run status’ are connected to the digital inputs as described in **Chapter 2 Installation**, and the input **Type P\*372, 375, 378, 381, 384, 387, 390** is configured as detailed in **Input Type**, earlier in this chapter.

**Pump 1** is connected and programmed to operate on **Relay 1**

**Pump 2** is connected and programmed to operate on **Relay 2**

**Pump 1 Fail** signal is connected to **Digital Input 1**

**Pump 2 Fail** signal is connected to **Digital Input 2**

Each digital input must be assigned to the device relay output that it relates to, this is determined by **Assignment P\*374, 377, 380, 383, 386, 389, 392**. In the case of our example **Digital Input 1** will be assigned to **Relay 1 (P\*374 = 1)** and **Digital Input 2** will be assigned to **Relay 2 (P\*377 = 2)**.

When the level rises to the ON Setpoint of Relay 1, the relay will energise and Pump 1 will ‘start’, in the normal manner. If the pump starts and runs correctly no change of ‘run’ status will be seen on the digital input and the pump(s) will be allowed to operate as programmed.

Should a pump **fail**, a change of ‘run’ status would be seen and a **Device Fail**, condition would be detected on the corresponding digital input, this will result in the relay for the ‘failed’ pump being de-energised and the pump being switched OFF. The setpoints of the ‘failed’ pump will then be passed to the second pump, which will take over to complete the pumping operation.

The decision on whether or not to attempt to start the failed pump on subsequent pump cycles will be determined by **P\*300 Max. Attempts**. Once the number of attempts stipulated have been made the pump will be put out of service until such time the Device Fail input is cleared by a **Reset (P\*391 = 4)** on Digital Input 7. Alternatively, the +/- key can be used as a Hot Key, which when pressed, whilst the unit is in RUN, will give details of any **Device Fail** and provides prompts to **Reset** any failures to the **no fault** condition.

### **Duty**

When this function is selected the digital inputs are used to determine, via an 'auto/manual' switch, which one of the devices, connected to the relay outputs of the Twin, will be the "lead" or "duty" device.

Consider the example of an application using 2 pumps. Each pump is connected and controlled by one of the Twin relay outputs, the pump duty and setpoints have been programmed as detailed in **Using the Relays**, earlier in this chapter. The signals providing details on the "lead" or "duty" pump 'status' are connected to the digital inputs as described in **Chapter 2 Installation**, and the input **Type P\*372, 375, 378, 381, 384, 387, 390** is configured as detailed in **Input Type**, earlier in this chapter.

**Pump 1** is connected and programmed to operate on **Relay 1**

**Pump 2** is connected and programmed to operate on **Relay 2**

**Pump 1 Duty** signal is connected to **Digital Input 3**

**Pump 2 Duty** signal is connected to **Digital Input 4**

The type of switch to be used to determine the duty is selected and configured as detailed in **P\*301 Switch Mode**.

### **Standard Switch Mode (P\*301 = 0 Standard)**

When a standard rotary type switch is used, to determine auto/manual duty one input per device is required, with each input being assigned to the appropriate device relay output that it relates to, this is determined by **Assignment P\*374, 377, 380, 383, 386, 389, 392**. In the case of our example **Digital Input 3** will be assigned to **Relay 1 (P\*380 = 1)** and **Digital Input 4** will be assigned to **Relay 2 (P\*383 = 2)**.



When the **duty switch** is in the “**auto**” position, no signals are present on either Digital Input 3 or Digital Input 4 and devices will run in the “**auto**” mode, as determined by the Twin, in accordance with its programmed settings. If a signal is seen on Digital Input 3, **duty switch** selected for **Pump 1**, then the pump connected to Relay 1 will assume the role of “**lead**”/ “**duty**” pump, regardless of the settings programmed in the Twin.

When the level rises to the **ON Setpoint**, for the **first** pump, relay 1 will energise and Pump 1 will ‘start’, in the normal manner. If the level continues to rise, then relay 2 will energise and Pump 2 will start in accordance with the settings programmed for pump 2.

If a signal is seen on Digital Input 4, **duty switch** selected for **Pump 2**, then the pump connected to Relay 2 will assume the role of “**lead**”/ “**duty**” pump, regardless of the settings programmed in the Twin. When the level rises to the **ON Setpoint**, for the **first** pump, the relay 2 will energise and Pump 2 will ‘start’, in the normal manner. If the level continues to rise, then relay 1 will energise and Pump 1 will start in accordance with the settings programmed for pump 2.

**Binary Switch Mode (P\*301 = 1Binary)**

When a binary switch is used, to determine auto/manual duty, the number of inputs required will be dependent on the number of devices to be included in the duty selection. In this mode, the duty device will be selected according to the binary input present on the appropriate inputs and there is therefore no requirement to assign the duty switch inputs to specific device relay. The selection of the Lead/Duty device is determined by the presence of an input as detailed in the table below, where **0** = **no input** present and **1** = **input** present

Duty Input 1	Duty Input 2	Duty Input 3	Lead/Duty Device
0	0	0	Auto
1	0	0	Relay 1
0	1	0	Relay 2
1	1	0	Relay 3
0	0	1	Relay 4
1	0	1	Relay 5
0	1	1	Relay 6

Consider the example of an application using 2 pumps. Each pump is connected and controlled by one of the Twin relay outputs, the pump duty and setpoints have been programmed as detailed in **Using the Relays**, earlier in this chapter. The signals providing details on the “lead” or “duty” pump ‘status’ are connected to the digital inputs as described in **Chapter 2 Installation**, and the input **Type P\*372, 375, 378, 381, 384, 387, 390** is configured as detailed in **Input Type**, earlier in this chapter.

**Pump 1** is connected and programmed to operate on **Relay 1**

**Pump 2** is connected and programmed to operate on **Relay 2**

**Duty Input 1** signal is connected to **Digital Input 3**

**Duty Input 2** signal is connected to **Digital Input 4**

When no signals are present on either Digital Input 3 or Digital Input 4 then devices will run in the “**auto**” mode, as determined by the Twin, in accordance with its programmed settings. If a signal is seen on Digital Input 3, **duty** selected for **Pump 1**, then the pump connected to Relay 1 will assume the role of “lead”/ “duty” pump, regardless of the settings programmed in the Twin. When the level rises to the **ON Setpoint**, for the **first** pump, relay 1 will energise and Pump 1 will ‘start’, in the normal manner. If the level continues to rise then relay 2 will energise and Pump 2 will start in accordance with the settings programmed for pump 2.

If a signal is seen on Digital Input 4, **duty** selected for **Pump 2**, then the pump connected to Relay 2 will assume the role of “lead”/ “duty” pump, regardless of the settings programmed in the Twin. When the level rises to the **ON Setpoint**, for the **first** pump, the relay 2 will energise and Pump 2 will ‘start’, in the normal manner. If the level continues to rise, then relay 1 will energise and Pump 1 will start in accordance with the settings programmed for pump 2.

### **Override**

A digital input can be assigned to receive an input, which will **override** the setpoints of the pumps and **start** them, as determined by the **Override Level (P\*306)** and providing the level is above **the Min. Override (P\*303)**, immediately after the expiry of the **Override Delay (P\*302)**. A digital input can also be assigned to receive an input, which will **override** the setpoints of the pumps and **stop** them immediately after the expiry of the **Override Delay (P\*302)**.

## **Reset**

This option is only available on Digital Input 7 **P\*391 = 5** when selected a valid signal received on this input will **Reset** all **Device Fail** signals to the **no-fault** condition. When using this function, the unit will check all inputs for such conditions so there is no requirement to assign the input to a specific relay output. Alternatively, the +/- key has been allocated as a Hot Key, which when pressed will give details of any **Device Fail** and provides prompts to **Reset** any failures to the **no-fault** condition.

## **Digital Input Parameters**

The following parameters are used to configure the use of the digital inputs.

### **Common Par.**

#### ***P1 and P2***

These parameters are common to each of the digital inputs and set specific operational criteria for particular functions.

#### ***P\*300 Max.Attempts***

When digital inputs are used to detect device failure this parameter determines the number of attempts that will be made before failing the device and putting it out of service. When the number of attempts is set to '0', there is no restriction on the number of starts. The digital inputs will provide a fail signal in the normal manner and initiate any action as required, but the device will not be put out of service. Any figure other than 0 will determine the number of attempts that will be made to start the device before putting it out of service until such time that the input is reset.

Set the number of attempts Min. 0, Max 99. **Default = 1**

### ***P\*301 Switch Mode***

When an external duty switch is used, this can be connected via the digital inputs and facilitate the selection of the duty device manually, thereby overriding the duty programmed within the unit.

This parameter determines the type of switch in use.

<b>Option</b>	<b>Description</b>
<b>0 = Standard (Default)</b>	A standard switch, e.g. rotary switch, can be used with one switch position and a digital input required for each pump.
1 = Binary	To reduce the number of digital inputs used, for manual duty selection, a binary switch can be supplied. Max. No. of digital inputs required being three.

### ***P\*302 Override Delay***

A digital input can be assigned to receive an input, which will override the setpoints of the pumps and start them, providing the level is above **the Min. Override (P\*303)**, immediately after the expiry of the Override Delay.

Enter the required delay time in minutes. **Default = 0.0 feet.**

### ***P\*303 Min Override***

Determines the minimum level required before an **Override Delay (P\*302)** will be in effect.

Enter the required level in **Measurement Units (P\*104)**.  
**Default = 0.0 feet.**

### ***P\*304 Input Delay***

This parameter determines the delay applied, from the time a device (relay) is called to “run” and when the status of the digital input is recognised as a valid input. If the digital input is used to detect a “running” signal this parameter should be set to reflect the time it takes from the device being called to “run” to the input being in its operational status.

Enter the required delay time in seconds. **Default = 10 seconds.**

### **P\*305 Input Filter**

This parameter is used to ignore spurious changes of state on the digital inputs and determines the time that a change of state has to be present before it is recognised as a valid input.

Enter the required filter time in seconds. **Default = 1 second.**

## **Digital Inputs**

### **P1 and P2**

The Twin provides 4 Digital Inputs on the Wall mount model and seven on the Fascia model.

The following parameters are used to configure the use of the digital inputs.

### **P\*372, P\*375, P\*378, P\*381, P\*384, P\*387, P\*390 - Type**

Determines the way digital inputs will be recognised by the *Ultra Twin*.

<b>Option</b>	<b>Description</b>
1 = Input N.C.	Ultra Twin recognises a <b>closed</b> condition, D.C. <b>signal</b> voltage <b>present</b> at the <b>input</b> , as a healthy/run condition.
2 = Input N.O.	<i>Ultra Twin</i> recognises an <b>open</b> condition, D.C. <b>signal</b> voltage <b>not present</b> at the input, as a healthy/run condition.

### **P\*373, P\*376, P\*379, P\*382, P\*385, P\*388, P\*391 - Function**

This parameter will set the function of the digital Input.

<b>Option</b>	<b>Description</b>
1 = Device Fail	Digital input is used to Fail, (put out of service), a device connected to the relay specified in <b>P*374, 377, 380, 383, 386, 389, 392 Assignment</b> .
2 = Duty	Digital input is used to select the device, (pump), connected to the relay specified in <b>P*374, 377, 380, 383, 386, 389, 392 Assignment</b> as the current duty device (pump).

<b>Option</b>	<b>Description</b>
3 = Override On	Digital input is used to provide a signal to instigate an Override and switch all <b>Pump</b> relays “ <b>ON</b> ”, as determined by <b>P*374, 377, 380, 383, 386, 389, 392 (Assignment), P*302 (Override Delay) and P*303 (Min. Override).</b>
4 = Override Off	Digital input is used to provide a signal to instigate an Override and switch all <b>Pump</b> relays “ <b>OFF</b> ”, as determined by <b>P*374, 377, 380, 383, 386, 389, 392 (Assignment), P*302 (Override Delay) and P*303 (Min. Override).</b>
5 = Reset. (Wall mount Input 4 only) (Fascia Input 7 only)	Input is used to <b>Reset all Device Fail</b> conditions. Alternatively, the +/- key can be used, whilst the in RUN, to <b>Reset any Device</b>
6 = Inhibit Meas.	Input is used to inhibit the measurement of the point it is allocated too as specified by <b>P*374, 377, 380, 383, 386, 389, 392 (Assignment).</b>

***P\*374, P\*377, P\*380, P\*383, P\*386, P\*389, P\*392 Assignment***

**When P\*373, 376, 379, 382, 385, 388, 391 = 1 (Device Fail) or 2 (Duty)**

This parameter assigns the digital input to the appropriate device relay that the **Function, (P\*373, 376, 379, 382, 385, 388, 391)**, is to be applied.

<b>Option</b>	<b>Description</b>
0 = None	Digital Input is not assigned to any relay.
<b>1 = Relay 1 (Default)</b>	Digital input is assigned to Device connected to Relay 1.
2 = Relay 2	Digital input is assigned to Device connected to Relay 2.
3 = Relay 3	Digital input is assigned to Device connected to Relay 3.
4 = Relay 4	Digital input is assigned to Device connected to Relay 4.
5 = Relay 5	Digital input is assigned to Device connected to Relay 5.
6 = Relay 6	Digital input is assigned to Device connected to Relay 6.

When **P\*373, 376, 379, 382, 385, 388, 391 = 3 (Override ON)** or **4 (Override OFF)**

This parameter assigns the digital input to the appropriate device relay that the **Function, (P\*373, 376, 379, 382, 385, 388, 391)**, is to be applied.

Option	Description
<b>0 = None (Default)</b>	Digital Input is not assigned to either point of measurement.
1 = Point 1	Digital input is assigned to operate on pump relays allocated to Point 1.
2 = Point 2	Digital input is assigned to operate on pump relays allocated to Point 2.
3 = Point 1 & 2	Digital input is assigned to operate on pump relays allocated to both Point 1 & 2

When **P\*373, 376, 379, 382, 385, 388, 391 = 6 (Inhibit Measurement)**

This parameter assigns the digital input to the appropriate device relay that the **Function, (P\*373, 376, 379, 382, 385, 388, 391)**, is to be applied.

Option	Description
<b>0 = Channel 1 (Default)</b>	Digital Input is assigned to Inhibit Measurement on Point 1.
1 = Channel 2	Digital Input is assigned to Inhibit Measurement on Point 2.

## Data Log Parameters

The data log parameters contain the following information.

### **Totaliser Audits**

*P1 or P2*

When **P1-100, P2-100 = 4 (OCM Head) or 5 (OCM Flow)**

***P1-460 to 479, P2-460 to 479 Total Audits***

The *Ultra Twin* can give independent Totaliser Audits for each point of measurement when the **Mode, (P1-100 or P2-100)**, selected is **OCM Head** or **Flow**. Parameters **P1-460, P2-460 to P1-479, P2-479** show the **date** and daily **flow** total for the last **ten days**, the first on the list are the most recent and last ones are the oldest. When all ten total audits are full the oldest is pushed out and all totals increment through to allow the new days total to be registered in the first day's total audit parameter allocation.

#### **Important Information**

In order to ensure the accuracy of Flow during a 24-hour period, ensure that the **Time P\*932** is set correctly. And if required, enable **Daylight Saving** for the appropriate time difference **P\*970 – P\*979**.

***P1-480, P2-480 Clear Logs***

This parameter enables **all** the Total Audits (P1-460 to 479, P2-460 to 479) to be cleared to factory default values.

### **Temperature**

*P1 or P2*

The following parameters give information on temperature conditions, for each point of measurement, as seen by the **Temperature source (P1-852, P2-852)** in °C. All of these parameters are read only and cannot be changed, though if P1-852, P2-852 are changed they will be reset.

***P1-580, P2-580 Minimum Temperature***

This parameter displays the minimum temperature recorded.

***P1-581, P2-581 Minimum Temperature Date***

This parameter displays the date when the minimum temperature was recorded.



***P1-582, P2-582 Minimum Temperature Time***

This parameter displays the time when the minimum temperature was recorded.

***P1-583, P2-583 Maximum Temperature***

This parameter displays the maximum temperature recorded.

***P1-584, P2-584 Maximum Temperature Date***

This parameter displays the date when the maximum temperature was recorded.

***P1-585, P2-585 Maximum Temperature Time***

This parameter displays the time when the maximum temperature was recorded.

***P1-586, P2-586 Current Temperature***

This parameter displays the current temperature.

**Pump Logs**

***P1 and P2***

***P\*511 Pump 1 Hours***

When Relay 1 is programmed as a Pump this parameter displays the current total running hours for Pump 1. Any value from 0 - 9999 can be entered to facilitate any update to the stored total for any reason e.g. a replacement pump being fitted.

***P\*512 Pump 1 Starts***

When Relay 1 is programmed as a Pump this parameter displays the current total pump starts for Pump 1. Any value from 0 - 9999 can be entered to facilitate any update to the stored total for any reason e.g. a replacement pump being fitted.

***P\*513 Pump 1 Starts/Hour***

When Relay 1 is programmed as a Pump this parameter displays the current pump Starts/Hour for Pump 1. Any value from 0 - 9999 can be entered to facilitate any update to the stored total for any reason e.g. a replacement pump being fitted.

### ***P\*521 – P\*523 Pump 2***

When Relay 2 is programmed as a Pump, these parameters contain the same information as above for Pump 2.

### ***P\*531 – P\*533 Pump 3***

When Relay 3 is programmed as a Pump These parameters contain the same information as above for Pump 3.

### ***P\*541 – P\*543 Pump 4***

When Relay 4 is programmed as a Pump These parameters contain the same information as above for Pump 4.

### ***P\*551 – P\*553 Pump 5***

When Relay 5 is programmed as a Pump These parameters contain the same information as above for Pump 5.

### ***P\*561 – P\*563 Pump 6***

When Relay 6 is programmed as a Pump These parameters contain the same information as above for Pump 6.

## **Volume**

### **When P1-100, P2-100 = 6 (Volume)**

Your *Ultra Twin* provides a variety of volume calculation features, **with 11** pre-programmed **vessel shapes**. See **Vessel Shape (P1-600, P2-600)** for more information. For each vessel you will need to know the **dimensions (P1-601 to 603, P2-601 to 603)** in **Measurement Units (P\*104)** which are required to calculate the **volume (P1-604, P2-604)** which will be displayed in the selected **Volume Units (P1-605, P2-605)**.

If your vessel shape does not correspond with any of the pre-programmed vessel shapes, then you can use the **universal calculations**. For this you will need a level/volume graph or chart provided by the vessel manufacturer or you can create one based on the dimensions of the vessel. You can enter up to 32 pairs of breakpoints, and the more you enter, the greater accuracy of the volume calculation will be.

## **Conversion**



*P1 or P2*

### ***P1-600, P2-600 Vessel Shape***

This parameter determines which vessel shape is used when utilising “Volume Conversion”.

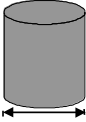
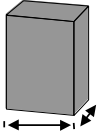
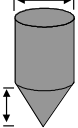
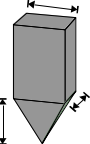
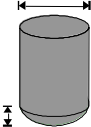
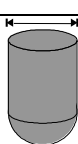
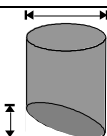
The choices are as shown in the table below, along with the **dimensions** that are required to be entered (**P1-601 to 603, P2-601 to 603**).

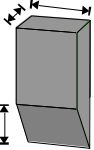
<b>Vessel Shape</b>	<b>P600 Value</b>	<b>Dimensions</b>
	<b>P1-600, P2-600 = 0</b> <b>Cylindrical Flat base</b> <b>(Default)</b>	Cylinder diameter
	P1-600, P2-600 = 1 Rectangular Flat base	Width and Breadth
	P1-600, P2-600 = 2 Cylindrical Cone base	Cylinder diameter and height of bottom
	P1-600, P2-600 = 3 Rectangular Pyramid base	Width and Breadth of rectangular section and height of bottom
	P1-600, P2-600 = 4 Cylindrical Parabola base	Cylinder diameter and height of bottom
	P1-600, P2-600 = 5 Cylindrical Half-sphere base	Cylinder Diameter
	P1-600, P2-600 = 6 Cylindrical Flat sloped base	Cylinder diameter and height of bottom

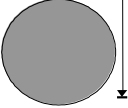
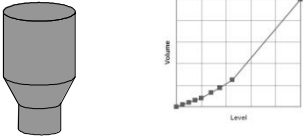
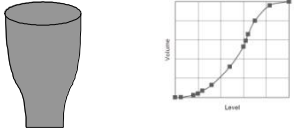
Vessel Shape	P600 Value	Dimensions
	P1-600, P2-600 = 7 Rectangular Flat sloped base	Width and Breadth of rectangular section and height of bottom
	P1-600, P2-600 = 8 Horizontal cylinder with flat ends	Cylinder diameter and tank length
	P1-600, P2-600 = 9 Horizontal cylinder with parabolic ends	Cylinder diameter, length of one end section, and tank length
	P1-600, P2-600 = 10 Sphere	Sphere diameter
	P1-600, P2-600 = 11 Universal Linear	No dimensions required, level and volume breakpoints used.
	P1-600, P2-600 = 12 Universal Curved	No dimensions required, level and volume breakpoints used.

**P1-601to 603, P2-601 to 603 Vessel Dimensions**

These three parameters are used to enter the dimension required to calculate the volume. The dimensions required are as shown below and are entered **Measurements Units (P\*104)**.

<b>Vessel Shape</b>	<b>P1-601 P2-601</b>	<b>P1-602 P2-602</b>	<b>P1-603 P2-603</b>
P1-600, P2-600 = 0 Cylindrical Flat base	Cylinder Diameter		
P1-600, P2-600 = 1 Rectangular Flat base		Width of rectangle	Breadth of rectangle
P1-600, P2-600 = 2 Cylindrical Cone base	Height of base	Cylinder Diameter	
P1-600, P2-600 = 3 Rectangular Pyramid base	Height of base	Width of rectangle	Breadth of rectangle
P1-600, P2-600 = 4 Cylindrical Parabola base	Height of base	Cylinder Diameter	
P1-600, P2-600 = 5 Cylindrical Half-sphere base	Cylinder Diameter		
P1-600, P2-600 = 6 Cylindrical Flat sloped base	Height of base	Cylinder Diameter	
P1-600, P2-600 = 7 Rectangular Flat sloped base	Height of base	Width of rectangle	Breadth of rectangle
P1-600, P2-600 = 8 Horiz. cylinder, flat ends	Length of Cylinder	Cylinder Diameter	
P1-600, P2-600 = 9 Horiz. Cyl. parabolic ends	Length of Cylinder	Cylinder Diameter	Length of one end
P1-600, P2-600 = 10 Sphere	Sphere Diameter		

**P1-604, P2-604 Calculated Volume**

This parameter displays the maximum volume that has been calculated by the *Ultra Twin* and is a Read Only parameter. The volume displayed will be shown in **volume units (P1-605, P2-605)** and is the total volume available between **empty level (P1-105, P2-105)** and 100% of **span (P1-106, P2-106)**.

### ***P1-605, P2-605 Volume Units***

This parameter determines the units that you wish to display, for volume conversion. It is used in conjunction with **P1-607, P2-607 (maximum volume)**, and the units are shown on the display (subject to P1-810, P2-810). The choices are:

Option	Description
0 = No Units	Volume will be totalised with <b>no units</b>
1 = Tons	Volume will be totalised in <b>Tons</b>
2 = Tonnes	Volume will be totalised in <b>Tonnes</b>
3 = Cubic metres	Volume will be totalised in <b>cubic metres</b>
4 = Litres	Volume will be totalised in <b>litres</b>
5 = UK Gallons	Volume will be totalised in <b>UK Gallons</b>
6 = US Gallons	Volume will be totalised in <b>US Gallons</b>
<b>7 = Cubic feet (Default)</b>	Volume will be totalised in <b>cubic feet</b>
8 = Barrels	Volume will be totalised in <b>barrels</b>
9 = lbs (pounds)	Volume will be totalised in <b>lbs (pounds)</b>

### ***P1-606, P2-606 Correction Factor***

This parameter is used to enter a correction factor, when required, such as the specific gravity of the material so that the volume calculated is relative to the actual amount of material that can be contained between **empty level (P1-105, P2-105)** and 100% of **span (P1-106, P2-106)**. **Default = 1**

### ***P1-607, P2-607 Max Volume***

This parameter displays the actual maximum volume that has been calculated by the *Ultra Twin*, i.e. **P1-604, P2-604 Calculated Volume x P1-606, P2-606 Correction Factor**, and is a Read Only parameter. The volume displayed will be shown in **P1-605, P2-605 Volume Units** and is the total volume available between **empty level (P1-105, P2-105)** and 100% of **span (P1-106, P2-106)**.

## **Breakpoints**

### ***P1 or P2***

#### ***P1-610 to 673, P2-610 to 673 Level/Volume Breakpoints***

These parameters are used to create a profile of the vessel when **P1-600, P2-600=11 (universal linear)** or **P1-600, P2-600 = 12 (universal curved)**. You should enter breakpoints in pairs, a reading for level and its corresponding volume. The more pairs you enter, the more accurate the profile will be. In the case of universal linear, then enter the level/volume at each of the points where the vessel changes shape. In the case of the universal curved, enter values around each arc tangent, as well as at the top and bottom.

You must enter at least two pairs, and you can enter up to 32 pairs.

#### ***Universal Linear (P1-600, P2-600 =11)***

This volume calculation creates a linear approximation of the level/volume relationship and works best if the vessel has sharp angles between each section.

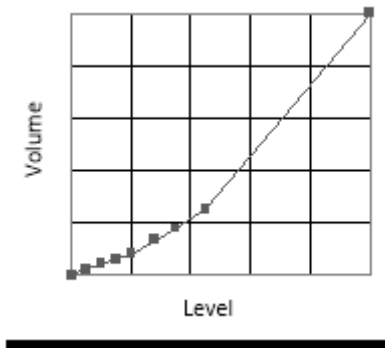

You should enter a level/volume breakpoint for each place where the vessel changes direction, and numerous where the section is slightly curved (mostly linear, but has got a small arc). You can enter any number of pairs between 2 and 32.

### **Universal Curved (P1-600, P2-600 =12)**

This volume calculation creates a curved approximation of the level/volume relationship, and works best if the vessel is non-linear, and there are no sharp angles.

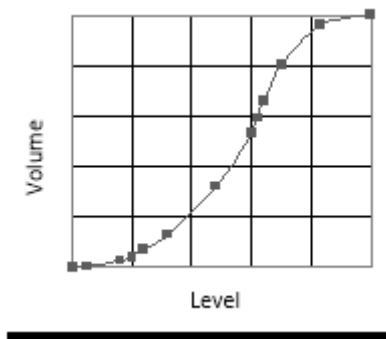

You should enter 2 level/volume breakpoints at the minimum and maximum levels, and several for each place where the vessel has got an arc. You can enter any number of pairs between 2 and 32.

## **Tables**

### ***P1 or P2***

#### ***P1-696, P2-696 Reset Breakpoints***

This parameter allows the resetting, to the default value, of all previously set breakpoints (P1-610 to 673, P2-610 to 673), without having to access them individually. When it is necessary to reset or amend particular breakpoints this can be achieved by directly accessing the desired parameter (P1-610 to 673, P2-610 to 673) and changing as required.

#### ***P1-697, P2-697 Number of Breakpoints Set***

This parameter allows you to review the number of breakpoints that have been set, without the need to access each individual one in turn, this is a “Read Only” parameter and no values can be entered.



## **OCM Parameters**

When P1-100, P2-100 = 4 (OCM Head) or 5 (OCM Flow)

### **PMD Setup**

*P1 or P2*

***P1-700, P2-700 Primary Measuring Device Type***

This parameter is used to select the **type** of **Primary Measuring Device** and enable additional parameters required to calculate the flow of the Primary Measuring Device chosen (P1-701, P2-701). Options are as follows:

**0 = Off (Default)**

1 = Exponent

2 = BS3680 Flume

3 = BS3680 Weir

4 = Not Available

5 = Special

6 = Universal

***P701 Primary Measuring Device***

Enter the Primary Measuring Device used.

**If P1-700, P2-700 = 1 (Exponent)**

Select from the following options:

1 = Suppressed Rectangular Weir

2 = Cipolletti (Trapezoidal) Weir

3 = Venturi Flume

4 = Parshall Flume

5 = Leopold Lagco Flume

6 = V- notch Weir,

7 = Others

**If P1-700, P2-700 = 2 (BS 3680 Flume)**

Select from the following options:

1 = Rectangular

2 = Rectangular with hump

3 = U-throated

4 = U-Throated with hump

**If P1-700, P2-700 = 3 (BS 3680 Weir)**

Select from the following options:

- 1 = Rectangular
- 2 = V-Notch 90 degree (full 90°)
- 3 = V-Notch 53 degree 8' (half 90°)
- 4 = V-Notch 28 degree 4' (quarter 90°)
- 5 = Broad crested (Rectangular) Weir

**If P1-700, P2-700 = 5 (Special)**

Select from the following options:

- 1 = Palmer-Bowlus Flume
- 2 = H-Flume
- 3 = V-Notch angle (other than BS3680)

**If P1-700, P2-700 = 6 (Universal)**

Where the Primary Measuring device does not match any of the devices contained in the above categories then a universal volume calculation can be performed. A head Vs flow chart is used, to enter a number of **Breakpoints** for head and flowrate (**P1-730 to 793, P2-730 to 793**), which is either provided by the manufacturer or created based on the dimensions of the device.

Select from the following options:

- 1 = Universal Linear flow calculation
- 2 = Universal Curved flow calculation

***P1-702, P2-702 Calculation***

Select the required **calculation method**, both will give the same answer, but the difference is the information required to complete the calculation. For ratiometric it is normally sufficient to know the maximum flow at the maximum head. Choose between:

- 1 = Absolute
- 2 = **Ratiometric (Default)**

### ***P1-703, P2-703 Minimum Head***

This parameter is used to enter the **distance**, above empty, that represents **zero head** and **flow**. This feature is used in Primary Measuring Devices where the zero reference is at a higher level than the channel bottom, at the point of measure. Enter distance in **Measurement Units P\*104**.

### ***P1-704, P2-704 Maximum Head***

Enter the **head** value that represents **maximum flow**, enter in **Measurement Units P\*104**.

Note any change to the value of this parameter will be reflected in P1-106, P2-106 (Span) and vice versa.

### ***P1-705, P2-705 Maximum Flow***

When **P1-702, P2-702 = 2 Ratiometric** enter the **flow rate** value that occurs at **maximum head (P1-704, P2-704)**, enter in **volume units (P1-706, P2-706)** per **time units (P1-707, P2-707)**.

When **P1-702, P2-702 = 1 Absolute**, and all relevant flow parameters have been entered, the **maximum flow** that occurs **at maximum head P1-704, P2-704** will be calculated, after the unit is returned to RUN mode, and displayed in this parameter in **volume units (P1-706, P2-706)** per **time units (P1-707, P2-707)**.

### ***P1-706, P2-706 Volume Units***

Select the Volume Units to be used to display and calculate the flow rate from the options below:

<b>Option</b>	<b>Description</b>
<b>1= Litres (Default)</b>	<b>Flow will be calculated and displayed in Litres</b>
<b>2= Cubic metres</b>	<b>Flow will be calculated and displayed in Metres<sup>3</sup></b>
<b>3= Cubic feet</b>	<b>Flow will be calculated and displayed in Feet<sup>3</sup></b>
<b>4= UK Gallons</b>	<b>Flow will be calculated and displayed in UK Galls.</b>
<b>5= US Gallons</b>	<b>Flow will be calculated and displayed in US Galls.</b>
<b>6= Mill. USG</b>	<b>Flow will be calculated and displayed in Millions of US Galls.</b>

### ***P1-707, P2-707 Time Units***

Select the Time Units to be used with the Volume Units to determine the desired flow rate from the options below:

<b>Option</b>	<b>Description</b>
<b>1= per Second (Default)</b>	<b>Flowrate</b> will be calculated and displayed in <b>Volume units/Second</b>
2= per Minute	<b>Flowrate</b> will be calculated and displayed in <b>Volume units/Minute</b>
3= per Hour	<b>Flowrate</b> will be calculated and displayed in <b>Volume units/Hour</b>
4= per Day	<b>Flowrate</b> will be calculated and displayed in <b>Volume units/Day</b>

### ***P1-708, P2-708 Flow Decimal***

This parameter determines the number of decimal places in the flow rate reading during run mode. It can be set between 1 and 3. **Default = 2**

### ***P1-709, P2-709 Flow Cut Off***

This parameter is used to select the minimum flow, in a % of flow rate, which is to be totalised. Enter values in % of maximum flow. **Default = 5%.**

## **Dimensions**

### ***P1 or P2***

#### ***P1-710, P2-710 Dimension A***

This parameter is used to enter dimension “A” of the Primary Measuring Device, where applicable, **see table below for further details.**

#### ***P1-711, P2-711 Dimension B***

This parameter is used to enter to enter dimension “B” of the Primary Measuring Device, where applicable, **see table below for further details.**

#### ***P1-712, P2-712 Dimension C***

This parameter is used to enter to enter dimension “C” of the Primary Measuring Device, where applicable, **see table below for further details.**

#### ***P1-713, P2713 Dimension D***

This parameter is used to enter to enter dimension “D” of the Primary Measuring Device, where applicable, **see table below for further details.**

<b>Primary Measuring Device P* = P1 and P2</b>	<b>P1-710 P2-710 Dim "A"</b>	<b>P1-711 P2-711 Dim "B"</b>	<b>P1-712 P2-712 Dim "C"</b>	<b>P1-713 P2-713 Dim "D"</b>
P*-700 = 1 Exponent P*-701 = 1 Supp. Rectangular Weir P*-702 = 1 Absolute	Crest Width	Not Required	Not Required	Not Required
P*-700 = 1 Exponent P*-701 = 2 Trapezoidal Weir P*-702 = 1 Absolute	Crest Width	Not Required	Not Required	Not Required
P*-700 = 1 Exponent P*-701 = 5 Leopold Lagco Flume P*-702 = 1 Absolute	Throat Diameter	Not Required	Not Required	Not Required
P*-700 = 1 Exponent P*-701 = 6 V-Notch P*-702 = 1 Absolute	V-Notch Angle	Not Required	Not Required	Not Required
P*-700 = 2 BS 3680 Flume P*-701 = 2 Rectangular P*-702 = Absolute or Ratiometric	Approach Width	Throat Width	Throat Length	Not Required
P*-700 = 2 BS 3680 Flume P*-701 = 2 Rectangular with hump P*-702 = Absolute or Ratiometric	Approach Width	Throat Width	Throat Length	Hump height
P*-700 = 2 BS 3680 Flume P*-701 = 3 U-Throated P*-702 = Absolute or Ratiometric	Approach Width	Throat Width	Throat Length	Not Required
P*-700 = 2 BS 3680 Flume P*-701 = 4 U-Throated with hump P*-702 = Absolute or Ratiometric	Approach Width	Throat Width	Throat Length	Hump Height
P*-700 = 3 BS 3680 Weir P*-701 = 1 Rectangular P*-702 = Absolute or Ratiometric	Approach Width	Crest Width	Crest Height	Not Required
P*-700 = 5 Special P*-701 = 2 H-Flume P*-702 = Absolute or Ratiometric	Flume Size	Not Required	Not Required	Not Required
P*-700 = 5 Special P*-701 = 3 V-Notch angle P*-702 = Absolute or Ratiometric	V-Notch Angle	Not Required	Not Required	Not Required

**P1-714, P2-714 Roughness Coefficient (Ks)**

When P1-700, P2-700 = 2, BS3680 Flume this parameter is used to enter the roughness coefficient of the flume in millimetres, **see table below for further details.**

Surface Classification	Value of Ks	
	Good Example mm	Normal Value mm
<b>Plastics, etc.</b> Perspex, PVC or other smooth faced		0.003
Asbestos cement		0.015
Resin-bonded glass-fibre moulded against smooth forms of sheet metal or well sanded and painted timber	0.03	0.06
<b>Metal</b>		
Smooth, machined and polished metal	0.003	0.006
Uncoated sheet metal, rust free	0.015	0.03
Painted metal	0.03	0.06
Galvanized metal	0.06	0.15
Painted or coated casting	0.06	0.15
Uncoated casting	0.15	0.3
<b>Concrete</b>		
In-situ or precast construction using steel formwork, with all irregularities rubbed down or filled in	0.06	0.15
In-situ or precast construction using plywood or wrought timber framework	0.3	0.6
Smooth trowelled cement rendering	0.3	0.6
Concrete with thin film of sewage slime	0.6	1.5
<b>Wood</b>		
Planned timber or plywood	0.3	0.6
Well sanded and painted	0.03	0.06

**P1-715, P2-715 Water Temperature**

When P1-700, P2-700 = 2, BS3680 Flume this parameter is used to enter the mean water temperature in °C.

### ***P1-717, P2-717 Exponent***

This parameter is used to enter the exponent value when:  
P1-700, P2-700 PMD Type = 1 (Exponent) and P1-701, P2-701 Primary  
M.D = 7 (Other).

### ***P1-718, P2-718 K Factor***

This parameter is used to enter the K Factor when:  
P1-700, P2-700 PMD Type = 1 (Exponent) and P1-702, P2-702 Calculation  
= 1 Absolute **see below table for further details.**

<b>Primary Measuring Device P* = P1 and P2</b>	<b>K-Factor</b>
P*-700 = 1 Exponent P*-701 = 1 Supp. Rectangular Weir	Automatically Calculated
P*-700 = 1 Exponent P*-701 = 2 Trapezoidal Weir	Automatically Calculated
P*-700 = 1 Exponent P*-701 = 3 Venturi Flume	Obtain value and enter
P*-700 = 1 Exponent P*-701 = 4 Parshall Flume	Automatically Calculated
P*-700 = 1 Exponent P*-701 = 5 Leopold Lagco Flume	Automatically Calculated
P*-700 = Exponent P*-701 = 6 V-Notch	Automatically Calculated
P*-700 = 1 Exponent P*-701 = 7 Other	Obtain value And enter

### ***P1-719, P2-719 Throat Width***

This parameter is used to select the Throat Width of the flume when:  
P1-700, P2-700 PMD Type = 1 (Exponent) and P1-701, P2-701 = 4  
(Parshall Flume). After selecting the Throat Width, the Exponent P1-717,  
P2-717 and K Factor P1-718, P2-718 will be set automatically.

## **Calculations**

### ***P1 or P2***

The following parameters P1-720 to 725, P2-720 to 725 are values  
calculated by the unit, dependent on application, and are “Read Only”,  
therefore have no default values.

### ***P1-720, P2-720 Area***

Displays the calculated value of the area when, P1-700, P2-700 = 2 (BS3690  
flumes).

### ***P1-721, P2-721 Cv***

Displays the calculated value for Cv when, P1-700, P2-700 = 2 (BS3680 flumes).

### ***P1-722, P2-722 Cd***

Displays the calculated value for Cd when, P1-700, P2-700 = 2 (BS3680 flumes).

### ***P1-723, P2-723 Ce***

Displays the calculated value for Ce when, P1-700, P2-700 = 3 (BS3680 weirs).

### ***P1-724, P2-724 Cu***

Displays the calculated value for Cu when, P1-700, P2-700 = 2 (BS3680 flume) and P1-701, P2-701 = 3 or 4 (U-Throated flume).

### ***P1-725, P2-725 Kb***

Displays the calculated value for Kb when, P1-700, P2-700 = 3 (BS3680 weirs) and P1-701, P2-701 = 1 (Rectangular weir).

## **Breakpoints**

### ***P1 or P2***

#### ***P1-730 to P1-793, P2-730 to P2-793 Breakpoints***

Where the Primary Measuring device does not match any of the pre-programmed devices contained in the *Ultra Twin*, then a universal volume calculation can be performed. A head Vs flow chart is used, to enter a number of **Breakpoints** for the **head** and **flow (P1-730 to 793, P2-730 to 793)**, which is either provided by the manufacturer or created based on the dimensions of the device.

Breakpoints should be entered in **pairs** of **head** and the corresponding **flow** for that head. The **first pair** entered must be for **zero head** and **flow** and the **last pair** entered must be for **maximum head** and **flow**. The higher number of breakpoints (pairs) entered then the greater accuracy there will be. There are a maximum number of 32 breakpoints (pairs) for head and flow that can be entered.



## **Tables**

### ***P1 and P2***

#### ***P1-796, P2-796 Reset Breakpoints***

This parameter allows the resetting, to the default value, of all previously set breakpoints (P1-730 to 793, P2-730 to 793), without having to access them individually. When it is necessary to reset or amend particular breakpoints this can be achieved by directly accessing the desired parameter (P1-730 to -793, P2-730 to 793) and changing as required.

#### ***P1-797, P2-797 Number of Breakpoints Set***

This parameter allows you to review the number of breakpoints that have been set, without the need to access each individual one in turn, this is a “Read Only” parameter and no values can be entered.

## **Average Flow**

### ***P1 or P2***

#### ***P1-863, P2-863 Average Flow***

This parameter will display the Average Flow for the time period set in **Average Time (P1-864, P2-864)**. It is read only and cannot be changed.

#### ***P1-864, P2-864 Average Time***

This parameter will set the time period over which the Average Flow (P1-863, P2-863) is to be calculated before being displayed.

## **Display Parameters**

### **Options**

#### ***P1 or P2***

#### ***P1-800, P2-800 Display Units***

This parameter determines whether the reading displayed is in **Measurement Units (P\*104)**, or as a **percentage of span**.

Option	Description
<b>1 = Measured (Default)</b>	Display is in selected units dependant on Mode ( <b>P1-100, P2-100</b> )
<b>2 = Percentage</b>	Display is in <b>percentage</b> of span dependant on Mode ( <b>P1-100, P2-100</b> ).

#### ***P1-801, P2-801 Decimal Places***

This parameter determines the number of decimal places on the reading during run mode.

Minimum = 0 (No decimal places), Maximum 3 = (3 decimal Places)

**Default = 2** (2 decimal Places)

### ***P1-802, P2-802 Display Offset***

The value of this parameter is added to the reading before it is displayed, in **Measurement Units (P\*104)**.

It does not affect the relay setpoints or the mA output, only the reading on the display.

You could use this feature if for example you wanted to reference the reading to sea level, where you would enter the distance between **Empty Level (P1-105, P2-105)** and sea level. If the empty level point is below sea level, then enter a negative value.

### ***P1-804, P2-804 Display Conversion***

The reading is multiplied by the value of this parameter before being displayed. The default is 1.0, but if for example you wanted to display the reading in yards, then set the **Measurement Units (P\*104)** to feet, and set **P1-804, P2-804** to 3.

### ***P1-805, P2-805 Display Source***

This parameter determines which point(s) of measurement the display will relate to.

<b>Option</b>	<b>Description</b>
1= Point 1	Displays <b>Point 1</b> calculated values in <b>chosen Measurement Units</b> .
2= Point 2	Displays <b>Point 2</b> calculated values in <b>chosen Measurement Units</b> .
3= Avg. 1 & 2	Displays calculated <b>average</b> values of <b>Point 1 &amp; 2</b> in <b>chosen Measurement Units</b> .
4= Sum 1 + 2	Displays calculated <b>sum</b> values of <b>Point 1 + 2</b> in <b>chosen Measurement Units</b> .
5= Diff. 1 - 2	Displays calculated differential values of <b>Point 1 - 2</b> in <b>chosen Measurement Units</b> .

#### **Important Information**

When the display is to be used to show the value of the **average, differential** or **sum** of two points of measurement, then **both points** must be set to the **same** units of measurement. In the case of **flow (P1-100 and P2-100)** are set for **4 (OCM Head)** or **5 (OCM Flow)**, then **P1-706, P2-706 (Volume Units)** & **P1-707, P2-707 (Time Units)** must be the same. In case the of **Volume** then **P1-100 and P2-100** are set for **6 (Volume)** then **P1- 605, P2-605 (Volume Units)** must be the same.

## **Failsafe**

*P1 or P2*

### ***P1-808, P2-808 Fail-safe Mode***

By default, if a fail-safe condition occurs, then the display, relays and the mA output are held at their last **known** values until a valid reading is obtained.

If required, then you can change this so that the unit goes to **high** (100% of span), or **low** (empty) as follows:

<b>Option</b>	<b>Description</b>
<b>1 = Known (Default)</b>	Remain at the last <b>known</b> value
<b>2 = High</b>	Will fail to the <b>high</b> value (100% of Span).
<b>3 = Low</b>	Will fail to the <b>low</b> value (empty)

— See Also **P\*218, P\*228, P\*238, P\*248, P\*258, P\*268 - Relay Fail-safe and P\*840 – mA 1 Output Fail-safe and P\*898 – mA 2 Fail-safe.**

#### **Important Information**

In the event of a **fail-safe** condition occurring, the displays, relays and mA Outputs can be configured to fail to a condition which is independent of each other. To set independent **Relay Failsafe** see **P\*218, P\*228, P\*238, P\*248, P\*258, P\*268**. For independent **mA 1 Output Failsafe** see **P\*840** and **mA 2 Output Failsafe** see **P\*898**.

### ***P1-809, P2-809 Fail-safe Time***

In the event of a fail-safe condition the failsafe timer determines the time before fail-safe mode is activated. **Default = 2mins**

If the timer activates, the unit goes into **fail-safe**, as determined by **P1-808, P2-808 (Display), P\*218, 228, 238, 248, 258, 268 (Relays), P\*840 (mA 1 Output) and P\*898 (mA 2 Output)**. When this happens, you will see the message “**Failed Safe!**” on the display, along with a message explaining why (lost echo or transducer fault, for example)

When a valid measurement is obtained then the display(s), relays and mA output(s) will be restored and the timer is reset.

## **Auxiliary**

### ***P1 or P2***

#### ***P1-810, P2-810 Units***

This parameter determines whether the selected units of measurement are displayed on the auxiliary line of the display in run mode.

Option	Description
0 = No	Measurement units <b>will not</b> be displayed
<b>1 = Yes (Default)</b>	Measurement units <b>will</b> be displayed

#### ***P1-811, P2-811 Alarms Messages***

This parameter determines whether notification messages are displayed on the auxiliary line of the display in run mode when an alarm relay is switched on or off. The message is in the form “Alarm High ON”, where the ‘High’ is determined by the setting of the relay **Alarm ID (P\*212, 222, 232, 242, 252, 262)**.

Option	Description
<b>0 = No (Default)</b>	Alarm messages <b>will not</b> be displayed
1 = Yes	Alarm messages <b>will</b> be displayed

#### ***P1-812, P2-812 Pump Messages***

This parameter determines whether notification messages are displayed on the auxiliary line of the display in run mode when a pump relay is switched on or off. The message is in the form “General 1 ON”, where the number displayed is the number of the relay.

Option	Description
<b>0 = No (Default)</b>	Pump messages <b>will not</b> be displayed
1 = Yes	Pump messages <b>will</b> be displayed

#### ***P1-813, P2-813 Control Messages***

This parameter determines whether notification messages are displayed on the auxiliary line of the display in run mode when a control relay is switched on or off. The message is in the form “Time ON”.

Option	Description
<b>0 = No (Default)</b>	Control messages <b>will not</b> be displayed
1 = Yes	Control messages <b>will</b> be displayed

### **P1-814, P2-814 Miscellaneous Messages**

This parameter determines whether notification messages are displayed on the auxiliary line of the display in run mode when a miscellaneous relay is switched on or off. The message is in the form “Clock ON”.

Option	Description
<b>0 = No (Default)</b>	Misc. messages <b>will not</b> be displayed
1 = Yes	Misc. messages <b>will</b> be displayed

### **P1-815, P2-815 Auxiliary Mode**

The auxiliary display can be used to give additional information on calculated values of a **point(s)** of measurement, as **determined** by **P1-816, P2-816 Auxiliary Source**.

The information available to be displayed will be dependent on the selected **Mode P1-100, P2-100**, and the options are as follows:

Option	Description
1 = Distance	<b>Values</b> related to <b>distance</b> will be <b>displayed</b> .
<b>2 = Level (Default)</b>	<b>Values</b> related to <b>level</b> will be <b>displayed</b> .
3 = Space	<b>Values</b> related to <b>space</b> will be <b>displayed</b> .
4 = Head	<b>Values</b> related to <b>head</b> will be <b>displayed</b> .
5 = Flow	<b>Values</b> related to <b>flow</b> will be <b>displayed</b> .
6 = Volume	<b>Values</b> related to <b>volume</b> will be <b>displayed</b> .
7 = Totaliser (R)	<b>Values</b> related to <b>totaliser(s)</b> will be <b>displayed</b> .

### **P1-816, P2-816 Auxiliary Source**

This parameter determines which point or points of measurement, dependent on the selected **Mode (P1-100 and P2-100)**, that the auxiliary display will relate to and the options are as follows:

Option	Description
<b>0 = Off (Default)</b>	Auxiliary display <b>not used</b> to display values
1= Point 1	Displays <b>Point 1</b> calculated values.
2= Point 2	Displays <b>Point 2</b> calculated values.
3= Avg. 1 & 2	Displays calculated <b>average</b> values of <b>Point 1 &amp; 2</b> .
4= Sum 1 + 2	Displays calculated <b>sum</b> values of <b>Point 1 + 2</b> .
5= Diff. 1 - 2	Displays calculated <b>differential</b> values of <b>Point 1-2</b> .

### Important Information

When the auxiliary display is to be used to show the value of the **average**, **differential** or **sum** of two points of measurement, then **both points** must be set to the **same** units of measurement. In the case of **flow P1-100** and **P2-100** are set for **4 (OCM Head)** or **5 (OCM Flow)**, then **P1-706, P2-706 (Volume Units)** & **P1-707, P2-707 (Time Units)** must be the same. And in case of the **Volume** then **P1-100** and **P2-100** are set for **6 (Volume)** then **P1- 605, P2-605 (Volume Units)** must be the same.

### When P1-815, P2-815 = 7 (Totaliser(R))

Option	Description
0 = Off (Default)	Auxiliary display <b>not used</b> to display values
1= Totaliser 1 (R)	Displays <b>Totaliser 1 (R)</b> in auxiliary display.
2= Totaliser 2 (R)	Displays <b>Totaliser 2 (R)</b> in auxiliary display.

When a resettable totaliser (Totaliser (R)) is selected to be displayed, the auxiliary display will scroll between the resettable totaliser and the relevant totaliser units.

The resettable totaliser can be reset whilst in run mode via the “Totaliser” hot key  by pressing “0” whilst Total (R) is displayed.

## Totaliser

### *P1 or P2*

The *Ultra Twin* has two totalisers which can be used to record and totalise flow, by default totaliser 1 (P1-820) will be allocated to point 1 and totaliser 2 (P2-820) to point 2, but when both points of measurement are being used to calculate **OCM Head** or **OCM Flow (P1-100 and P2-100 = 4 or 5)** either totaliser can be allocated the average of point 1 & 2, or the sum of 1 + 2. Both totalisers have an associated resettable totaliser P1-821 Totaliser 1 (R) and P2-821 Totaliser 2 (R) which can be displayed on the auxiliary display and reset whilst in run mode, with its mode of operation being determined by the Totaliser Mode P1-824, P2-824.

### *P1-820, P2-820 Totaliser 1&2*

Displays the current value of the non-resettable totaliser(s). During run mode, these totalisers can be viewed via the “Totaliser” hot key  Unlike the resettable totaliser these totalisers cannot be reset whilst in run mode, it can however be reset whilst in program mode by accessing **P1-820 Totaliser 1, P2-820 Totaliser 2** and entering **zero**.

### **P1-821, P2-821 Totaliser (R )1&2**

Displays the current value of the resettable totaliser(s), these **totalisers** can be allocated to appear, during **run mode**, on the auxiliary display line (**P1-816, P2-816**) or alternatively accessed via the “Totaliser” hot key 

### **P1-822, P2-822 Totaliser Decimal Places**

This parameter determines the number of decimal places in the totaliser(s) during run mode. It can be set between 1 and 3. **Default = 2**

### **P1-823, P2-823 Totaliser Multiplication Factor**

Use this parameter if the totaliser increments by to large or small amount, enter the factor by which the actual flow rate is multiplied by before incrementing the totaliser.

E.g. if volume is being calculated and displayed in ltrs and it is desired to increment the totaliser in cubic metres select  $7 = *1000$ .

When viewing, the totaliser display will state, “Units are: L\*1000”, and the totaliser will be incremented every 1000 litres

Options are:

Option	Description
1= 1/1000	Totaliser will increment every 1/1000 <sup>th</sup> units of volume
2= 1/100	Totaliser will increment every 1/100 <sup>th</sup> units of volume
3= 1/10	Totaliser will increment every 1/10 <sup>th</sup> units of volume
<b>4= 1 (Default)</b>	Totaliser will increment every 1 units of volume
5= 10	Totaliser will increment every 10 units of volume
6= 100	Totaliser will increment every 100 units of volume
7= 1,000	Totaliser will increment every 1000 units of volume
8= 10,000	Totaliser will increment every 10,000 units of volume
9= 100,000	Totaliser will increment every 100,000 units of volume
10= 1,000,000	Totaliser will increment every 1,000,000 units of volume

### **P1-824, P2-824 Totaliser Allocation**

This parameter determines which point(s) of measurement the totaliser(s) will react to.

Option	Description
<b>0 = Off (Default)</b>	Totaliser will be <b>disabled</b>
1 = Point 1 (P1-824)	<b>Totaliser 1</b> allocated to <b>Point 1</b>
2 = Point 2 (P2-824)	<b>Totaliser 2</b> allocated to <b>Point 2</b>
3= Avg. 1 & 2	<b>Totaliser</b> allocated to <b>Average</b> flow of <b>Point 1</b>
4= Sum 1 + 2	<b>Totaliser</b> allocated to <b>Sum</b> flow of <b>Point 1 + 2</b>

### Important Information

When the totaliser is to be used to totalise the **average** or **sum** of two points of flow measurement, then **both points** must be set to the **same** units of measurement i.e. **P1-100** and **P2-100** are set for **4 (OCM Head)** or **5 (OCM Flow)**, then **P1-706, P2-706 (Volume Units)** & **P1-707, P2-707 (Time Units)** must be the same, also the totalisers must have the **same** multiplication factor applied, **P1-823, P2-823 (Total.Multi)**.

## **Bargraph**

*P1 or P2*

### ***P1-829, P2-829 Bargraph***

By default, the bar graph will be representative of the **level** being measured, as a **percentage** of the **Span P1-106, P2-106**. This parameter is automatically set to the correct default option when selecting the **Mode P1-100, P2-100** but can be changed if required.

The options, dependant on the **value** entered for **Mode P1-100, P2-100** are as follows:

**P1-100, P2-100 = 1 (Distance), 2 (Level) or 3 (Space)**

Option	Description
<b>2 = Level (Default)</b>	Bargraph will be representative of level.

**P1-100, P2-100 = 4 (OCM Head) or 5 (OCM Flow)**

Option	Description
<b>2 = Level (Default)</b>	Bargraph will be representative of <b>level</b> .
<b>4 = Head</b>	Bargraph will be representative of <b>head</b> .
<b>5 = Flow</b>	Bargraph will be representative of <b>flow</b> .

**P1-100, P2-100 = 6 (Volume)**

Option	Description
<b>2 = Level (Default)</b>	Bargraph will be representative of <b>level</b> .
<b>6 = Volume</b>	Bargraph will be representative of <b>volume</b> .



## mA Output 1 Parameters

### Range

*P1 and P2*

**P\*830 mA1 Range**

This parameter determines the range of the mA output, from the following.

Option	Description
0= Off	mA output disabled.
1= 0 to 20 mA	mA output directly proportional to the <b>mA mode (P*831)</b> , so if the reading is 0% then the mA output is 0 mA. If the reading is 100% then the mA output is 20 mA.
<b>2= 4 to 20 mA (Default)</b>	mA output directly proportional to the <b>mA mode (P*831)</b> , so if the reading is 0% then the mA output is 4 mA. If the reading is 100% then the mA output is 20 mA.
3= 20 to 0 mA	mA output inversely proportional to the <b>mA mode (P*831)</b> , so if the reading is 0% then the mA output is 20 mA. If the reading is 100% then the mA output is 0 mA.
4= 20 to 4 mA	mA output inversely proportional to the <b>mA mode (P*831)</b> , so if the reading is 0% then the mA output is 20 mA. If the reading is 100% then the mA output is 4 mA.

### Operation

*P1 and P2*

**P\*831 mA1 Mode**

This parameter determines how the mA Output relates to what is measured. By **default**, it will be representative of the selected **Mode (P1-100)**, but, dependant on the Mode P1-100 it can be set to operate as follows:

**P1-100 = 1 (Distance), 2 (Level) or 3 (Space)**

Option	Description
<b>0 = Default</b>	mA output relative to <b>Mode P1-100</b>
1 = Distance	mA output relative to <b>distance</b> .
2 = Level	mA output relative to <b>level</b> .
3 = Space	mA output is relative to <b>space</b> .

## P1-100 = 4 (OCM Head) or 5 (OCM Flow)

Option	Description
<b>0 = Default</b>	mA output relative to Mode P1-100
1 = Distance	mA output relative to distance.
2 = Level	mA output relative to level.
3 = Space	mA output is relative to space.
4 = OCM Head	mA output is relative to OCM Head
5 = OCM Flow	mA output is relative to OCM Fow

## P1-100 = 6 (Volume)

Option	Description
<b>0 = Default</b>	mA output relative to <b>Mode P1-100</b>
1 = Distance	mA output relative to <b>distance</b> .
2 = Level	mA output relative to <b>level</b> .
3 = Space	mA output is relative to <b>space</b> .
6 = Volume	mA output is relative to <b>volume</b>

## Setpoint

### *P1 and P2*

By **default**, the mA output will represent the **empty (0 or 4mA)** dependant on **P\*830 (mA Range)** and **100%** of the operational **span (20mA)**, but you may wish to have the output represent a section of the operational span. For example, the application has an operational span of 20 feet but **output** is to **represent empty (0 or 4mA)** dependant on **P\*830 (mA Range)** to a **level of 15 feet (20mA)**. If so **P\*834 (Low Value)** should be set to **0.00** feet and **P\*835 (High Value)** should be set to **15 feet**.

### *P\*834 mA1 Low Value*

This parameter sets, in **Measurement Units (P\*104)**, the value of ‘level’, ‘distance’ or ‘space’, depending on the selected **mA Out Mode (P\*831)** at which the low mA output will occur (**0 or 4mA** dependant on (**P\*830**) **mA Range**)

**Default = 0.000 feet**

### *P\*835 mA1 High Value*

This parameter sets, in **Measurement Units (P\*104)**, the value of ‘level’, ‘distance’ or ‘space’, depending on the selected **mA Out Mode (P\*831)** at which the high mA output will occur (**20mA**).

**Default = 19.685 feet**

## **Limits**

### ***P1 and P2***

#### ***P\*836 mA1 Low Limit***

This parameter sets the lowest value that the mA output will drop to, the default is 0mA, but you can override this if the device you connect to cannot for example accept less than 2mA, yet you want to use the 0-20mA range.

**Default = 0.00mA**

#### ***P\*837 mA1 High Limit***

This parameter sets the highest value that the mA output will rise to, the default is 20 mA, but you can override this if the device you connect to cannot for example accept more than 18 mA, yet you want to use the 0-20 mA range.

**Default = 20.00mA**

## **Trim**

### ***P1 and P2***

#### ***P\*838 mA1 Low Trim***

If the remote device you are connected to is not calibrated, and not showing the correct **low value** (reading), then you can trim it using this parameter. You can either type in the offset directly or use the arrow keys to move the output up and down until you get the expected result (reading) on the remote device that is connected.

#### ***P\*839 mA1 High Trim***

If the remote device you are connected to is not calibrated, and not showing the correct **high value** (reading), then you can trim it using this parameter. You can either type in the offset directly or use the arrow keys to move the output up and down until you get the expected result (reading) on the remote device that is connected.

## **Failsafe**

### ***P1 and P2***

#### ***P\*840 mA1 Fail-safe Mode***

This parameter determines what happens to the mA output in the event of the unit going into fail-safe mode. The **default** is to do the same as the **system fail-safe (P1-808)**, but this can be overridden to force the mA output to an independent fail-safe mode as follows:

<b>Option</b>	<b>Description</b>
<b>0 = Default</b>	mA output will fail as per <b>P1-808</b> .
<b>1 = Hold</b>	mA output will retain its last known value.
<b>2 = Low</b>	mA output will fail to its <b>low</b> condition.
<b>3 = High</b>	mA output will fail to its <b>high</b> condition.

## **Allocation**

### ***P1 and P2***

#### ***P\*841 mA1 Allocation***

By default, the mA output 1 will be representative of the reading obtained, as determined by the **Mode P1-100**.

If required, mA output 1 can be configured to be representative of the average, difference or sum of two points of measurement.

E.g. Both **P1-100** and **P2-100 = 5 OCM Flow** then **mA Output 1** can be configured to give an output representative of flow on **point 1** or **flow on point 2** or the **average flow** of the **two points** or the sum of the **flow for both points**.

The options available are as follows:

<b>Option</b>	<b>Description</b>
<b>1= Point 1 (Default)</b>	mA 1 Output relates to <b>Point 1</b> .
<b>2= Point 2</b>	mA 1 Output relates to <b>Point 2</b> .
<b>3= Avg. 1 &amp; 2</b>	mA 1 Output relates to <b>average</b> of <b>Pt 1 &amp; Pt2</b> .
<b>4= Sum 1 + 2</b>	mA 1 Output relates to <b>differential</b> of <b>Pt 1 &amp; Pt2</b> .
<b>5= Diff. 1 – 2</b>	mA 1 Output relates to <b>sum</b> of <b>Pt 1 &amp; Pt2</b> .

### **Important Information**

When mA Output 1 is to be representative of the **average** or **sum** of two points of measurement, then **both points** must be set to the **same** units of measurement. In the case of **flow P1-100** and **P2-100** are set for **4 (OCM Head)** or **5 (OCM Flow)**, then **P1-706, P2-706 (Volume Units)** & **P1-707, P2-707 (Time Units)** must be the same. And in the case of **Volume** then **P1-100** and **P2-100** are set for **6 (Volume)** then **P1- 605, P2-605 (Volume Units)** must be the same.

### **Important Information**

When **both mA Output 1** and **mA Output 2** are **allocated** to the **same point** of measurement, in order for them to output the same reading, both of the **mA low value (P834/P892)** and **mA high value (P835/P893)** must be the **same** for each mA Output.

## mA Output 2 Parameters

### Range

*P1 and P2*

**P\*890 mA2 Range**

This parameter determines the range of the mA output, from the following.

Option	Description
0= Off	mA output disabled.
1= 0 to 20 mA	mA output directly proportional to the <b>mA mode (P*891)</b> , so if the reading is 0% then the mA output is 0 mA. If the reading is 100% then the mA output is 20 mA.
<b>2= 4 to 20 mA (Default)</b>	mA output directly proportional to the <b>mA mode (P*891)</b> , so if the reading is 0% then the mA output is 4 mA. If the reading is 100% then the mA output is 20 mA.
3= 20 to 0 mA	mA output inversely proportional to the <b>mA mode (P*891)</b> , so if the reading is 0% then the mA output is 20 mA. If the reading is 100% then the mA output is 0 mA.
4= 20 to 4 mA	mA output inversely proportional to the <b>mA mode (P*891)</b> , so if the reading is 0% then the mA output is 20 mA. If the reading is 100% then the mA output is 4 mA.

### Operation

*P1 and P2*

**P\*891 mA2 Mode**

This parameter determines how the mA Output relates to what is measured. By **default**, it will be representative of the selected **Mode (P2-100)**, but it can be set to operate as follows:

**P2-100 = 1 (Distance), 2 (Level) or 3 (Space)**

Option	Description
<b>0 = Default</b>	mA output relative to <b>Mode P1-100</b>
1 = Distance	mA output relative to <b>distance</b> .
2 = Level	mA output relative to <b>level</b> .
3 = Space	mA output is relative to <b>space</b> .

## P2-100 = 4 (OCM Head) or 5 (OCM Flow)

Option	Description
<b>0 = Default</b>	mA output relative to Mode P1-100
1 = Distance	mA output relative to distance.
2 = Level	mA output relative to level.
3 = Space	mA output is relative to space.
4 = OCM Head	mA output is relative to OCM Head
5 = OCM Flow	mA output is relative to OCM Flow

## P2-100 = 6 (Volume)

Option	Description
<b>0 = Default</b>	mA output relative to <b>Mode P1-100</b>
1 = Distance	mA output relative to <b>distance</b> .
2 = Level	mA output relative to <b>level</b> .
3 = Space	mA output is relative to <b>space</b> .
6 = Volume	mA output is relative to <b>volume</b>

## Setpoint

### *P1 and P2*

By **default**, the mA Output will represent the **empty (0 or 4mA)** dependant on **P\*890 (mA Range)** and **100%** of the operational **span (20mA)**, but you may wish to have the output represent a section of the operational span. For example, the application has an operational span of 20 feet, but **output** is to represent **empty (0 or 4mA)** dependant on **P\*890 (mA Range)** to a **level of 15 feet (20mA)**. If so **P\*892 (Low Value)** should be set to **0.00 feet** and **P\*893 (High Value)** should be set to **15 feet**.

### *P\*892 mA2 Low Value*

This parameter sets, in **Measurement Units (P\*104)**, the value of 'level', 'distance' or 'space', depending on the selected **mA Out Mode (P\*891)** at which the low mA output will occur (**0 or 4mA** dependant on (**P\*890**) **mA Range**)

**Default = 0.000 feet**

### *P\*893 mA2 High Value*

This parameter sets, in **Measurement Units (P\*104)**, the value of 'level', 'distance' or 'space', depending on the selected **mA Out Mode (P\*891)** at which the high mA output will occur (**20mA**).

**Default = 19.685 feet**

## **Limits**

### ***P1 and P2***

#### ***P\*894 mA2 Low Limit***

This parameter sets the lowest value that the mA output will drop to, the default is 0mA, but you can override this if the device you connect to cannot for example accept less than 2mA, yet you want to use the 0-20mA range.

**Default = 0.00mA**

#### ***P\*895 mA2 High Limit***

This parameter sets the highest value that the mA output will rise to, the default is 20 mA, but you can override this if the device you connect to cannot for example accept more than 18 mA, yet you want to use the 0-20 mA range.

**Default = 20.00mA**

## **Trim**

### ***P1 and P2***

#### ***P\*896 mA2 Low Trim***

If the remote device you are connected to is not calibrated, and not showing the correct **low value** (reading), then you can trim it using this parameter. You can either type in the offset directly, or use the arrow keys to move the output up and down until you get the expected result (reading) on the remote device that is connected.

#### ***P\*897 mA2 High Trim***

If the remote device you are connected to is not calibrated, and not showing the correct **high value** (reading), then you can trim it using this parameter. You can either type in the offset directly, or use the arrow keys to move the output up and down until you get the expected result (reading) on the remote device that is connected.



## **Failsafe**

### ***P1 and P2***

#### ***P\*898 mA2 Fail-safe Mode***

This parameter determines what happens to mA output 2 in the event of the unit going into fail-safe mode. The **default** is to do the same as the **system fail-safe (P2-808)**, but this can be overridden to force the mA output to an independent fail-safe mode as follows:

<b>Option</b>	<b>Description</b>
<b>0 = Default</b>	mA output will fail as per <b>P2-808</b> .
1 = Hold	mA output will retain its last known value.
2 = Low	mA output will fail to its <b>low</b> condition.
3 = High	mA output will fail to its <b>high</b> condition.

## **Allocation**

### ***P1 and P2***

#### ***P\*899 mA2 Allocation***

By default, the mA output 1 will be representative of the reading obtained, as determined by the **Mode P2-100**.

If required, mA output 2 can be configured to be representative of the average, difference or sum of two points of measurement.

E.g. Both **P1-100** and **P2-100 = 6 Volume** then **mA Output 2** can be configured to give an output representative of **volume on point 1** or **volume on point 2** or the **average volume** of the **two points** or the sum of the **volume for both points**.

The options available are as follows:

<b>Option</b>	<b>Description</b>
<b>1= Point 1 (Default)</b>	mA 1 Output relates to <b>Point 1</b> .
2= Point 2	mA 1 Output relates to <b>Point 2</b> .
3= Avg. 1 & 2	mA 1 Output relates to <b>average</b> of Pt 1 & Pt2.
4= Sum 1 + 2	mA 1 Output relates to <b>differential</b> of Pt 1 & Pt2.
5= Diff. 1 – 2	mA 1 Output relates to <b>sum</b> of Pt 1 & Pt2.

### **Important Information**

When mA Output 1 is to be representative of the **average** or **sum** of two points of measurement, then **both points** must be set to the **same** units of measurement. In the case of **flow P1-100** and **P2-100** are set for **4 (OCM Head)** or **5 (OCM Flow)**, then **P1-706, P2-706 (Volume Units)** & **P1-707, P2-707 (Time Units)** must be the same. And in the case of **Volume** then **P1-100** and **P2-100** are set for **6 (Volume)** then **P1- 605, P2-605 (Volume Units)** must be the same.

### **Important Information**

When **both mA Output 1** and **mA Output 2** are **allocated** to the **same point** of measurement, in order for them to output the same reading, both of the **mA low value (P834/P892)** and **mA high value (P835/P893)** must be the **same** for each mA Output.

## Compensation Parameters

### Offset

*P1 or P2*

#### ***P1-851, P2-851 Measurement Offset***

The value of this parameter is added to the measured distance, in **Measurement Units (P\*104)**.

This Offset will be added to the level, as derived from the transducer, and will affect everything including the reading on the display, the relay setpoints and the mA output(s) allocated to the relevant point.

### Temperature

*P1 or P2*

#### ***P1-852, P2-825 Temperature Source***

This parameter determines the source of the temperature measurement. By **default**, it is set to **automatic (P1-852, P2-852=1)**, which will automatically detect if a temperature sensor is available from the transducer(s). If for any reason, no temperature input is received, then the **Fixed Temp** value is used, as set by **P1-854, P2-854**.

The temperature source can be specifically set as follows:

Option	Description
<b>1 = Automatic (Default)</b>	Will automatically select transducer temperature sensor, if available, or fixed temperature (P1-854, P2-854) if no temperature sensor found.
2 = Xducer	Always uses temperature reading from transducer.
3 = Fixed	Always uses fixed temperature (P1-854, P2-854)
4 = Ext Range "A"	Uses an optional external temperature sensor with an operating range of -25°C to 50°C.
5 = Ext Range "B"	Uses an optional external temperature sensor with an operating range of -25°C to 125°C.

### ***P1-853, P2-853 Allocation***

This parameter determines which **transducer** is used to measure the **temperature** when **P1-852, P2-852 = 1 (Automatic)** or **2 (Xducer)**

Option	Description
<b>1 = Point 1</b> <b>(Default P1-853)</b>	Temperature reading will be obtained from Xducer on Point 1.
<b>1 = Point 2</b> <b>(Default P2-853)</b>	Temperature reading will be obtained from Xducer on Point 2.

### ***P1-854, P2-854 Fixed Temperature***

This parameter sets the temperature, in degrees centigrade to be used if **P1-852, P2-852 (Temperature Source) = 3 (Fixed)**. **Default = 20°C**

## **Velocity**

*P1 or P2*

### ***P1-860, P2-860 Sound Velocity***

This parameter allows for the velocity of sound to be changed according to the atmosphere the transducer is operating in. By default, the velocity is set for sound travelling in air at an ambient temperature of 20 degrees centigrade. **Default = 342.72m/sec**

### ***P1-861, P2-861 Cal.Dist***

This parameter is used to re-calibrate the speed of sound for the relevant point of measurement.

With the material at a steady level, **view** the value of **P1-861** or **P2-862**, which will indicate the **current distance** as calculated by the *Ultra Twin* with respect to the current **Velocity P1-860, P2-860**. Physically **measure** the **distance** from the face of the **transducer** to the surface of the **material level** and enter this value, in **Measurement Units P\*104** and **P1-860, P2-860** will be automatically updated to compensate for any difference between the displayed and entered values.

## **Stability Parameters**

### **Damping**

*P1 or P2*

Damping is used to damp the display, to enable it to keep up with the process but ignore minor surface fluctuations.

#### ***P1-870, P2-870 Fill Damping***

This parameter determines the **maximum rate** at which the unit will respond to an **increase in level**. It should be set slightly higher than the maximum vessel fill rate. **Default = 32.8084 feet/min**

#### ***P1-871, P2-871 Empty Damping***

This parameter determines the **maximum rate** at which the unit will respond to a **decrease in level**. It should be set slightly higher than the maximum vessel empty rate. **Default = 32.8084 feet/min**

### **Indicator**

*P1 or P2*

#### ***P1-872, P2-872 Fill Indicator***

This parameter determines the rate at which the LCD **fill** indicator activates. **Default = 32.8084 feet/min**

#### ***P1-873, P1-873 Empty Indicator***

This parameter determines the rate at which the LCD **empty** indicator activates. **Default = 32.8084 feet/min**

### **Rate**

*P1 or P2*

#### ***P1-874, P2-874 Rate Update***

This parameter determines the way in which the rate is calculated. If set to **continuous (P874=0)**, then the rate is calculated and displayed continuously, i.e. any change seen from shot to shot is calculated and displayed, but if set to use **values P874=1(Default)** then the **values** set in **P875** and **P876** are used to calculate and display the rate.

### ***P1-875, P2-875 Rate Time***

This parameter is the period (in seconds) over which the material level rate of change is averaged before the **Rate Value (P877)** is updated. If the **Rate Distance (P876)** is exceeded before the **Rate Time (P875)** has expired, then the **Rate Value (P877)** will be updated immediately. **Default = 60sec.**

### ***P1-876, P2-876 Rate Distance***

This parameter is the rate **Measurement Units (P104)** over which the material level must change before the **Rate Value (P877)** is updated. If the **Rate Time (P875)** expires before the **Rate Distance (P876)** is exceeded, then the **Rate Value (P877)** will be updated immediately. **Default = 0.164 feet.**

### ***P1-877, P2-877 Rate Value***

This parameter displays the current rate of change of material level, in **Measurement Units (P104)** per minute. It is read only.

### ***P1-878, P2-878 Lower Cutoff***

This parameter is used to select the minimum Rate to be calculated, and can be used to eliminate unwanted updates from effects of ripples/waves on the surface of the material.

## **Filters**

### ***P1 or P2***

The following parameters can be used to filter out unwanted changes of level caused by a 'rippled' or agitated surface.

### ***P1-880, P2-880 Gate Mode***

This parameter determines the operation of the gate that is established around the echo being processed and is used to track the echoes movement and update the level measurement indication on the display. Please consult Pulsar for further information and assistance on changing the value of this parameter, **Default = 0 (Fixed)**

### ***P1-881, P2-881 Fixed Distance***

This parameter determines the width of gate to be used in tracking an echo and under normal circumstances will not require changing, but it can be increased in the cases where the surface is moving extremely fast (in excess of 32.8084 feet/min) to ensure smooth processing of the changing level.

### ***P1-882, P2-882 Process Filter***

This parameter determines the number of ‘cycles’ that will be taken before a change in level is processed and the display updated.

Option	Description
1 = Fast	level will be updated every cycle
2 = Medium	level will be updated every 8 cycles
<b>3 = Slow (Default)</b>	level will be updated every 16 cycles

### ***P884 Peak Percentage***

When P1-102, P2-102 = 2 (Solids), this parameter can be used to determine the point at which the measurement is taken, within the established gate of the selected echo, in order to compensate for any error that maybe caused by “angles of repose” presented by the way the material settles. Please consult Pulsar for further information and assistance on changing the value of this parameter.

## **Echo Processing Parameters**

### **Transducer 1 Status**

#### ***P1-900 Transducer 1 Status***

This parameter shows the current state of the transducer on Point 1. The value means the following.

Option	Description
0= OK	Transducer working correctly.
1= Disabled	Transducer is not being used (mA input is being used instead, so P101=1)
2= Stuck High	Indicates that the power and signal lines on the transducer terminals are crossed over, or the signal line is shorted to earth.
3= Not Found	No transducer is detected.

#### ***P1-901 Echo Confidence1***

This parameter displays the most recent echo confidence from the transducer on Point 1. It is useful to help find the best mounting location for the transducer, where you should aim to get the highest figure. It is a percentage of confidence that the echo reporting the level is the correct one.

### ***P1-902 Echo Strength1***

This parameter displays the most recent echo strength figure from the transducer on Point 1, where a higher figure indicates a better returned echo.

### ***P1-903 Average Noise1***

This is the mean noise reading from the transducer on Point 1. It is measured while the transducer is not firing, and gives an indication of the average amount of electrical noise present on the cabling.

### ***P1-904 Peak Noise1***

This is the peak noise reading from the transducer on Point 1. It is measured while the transducer is not firing, and gives an indication of the maximum amount of electrical noise present on the cabling.

### ***P1-905 Sensitivity***

This parameter determines the sensitivity of the unit. Please consult Pulsar for further information and assistance on changing the value of this parameter.

### ***P1-906 Side Clearance***

This parameter is used to set the distance by which the DATEM trace will “stand-off” from around unwanted echoes such as obstructions. Please consult Pulsar for further information and assistance on changing the value of this parameter.

## **Transducer 2 Status**

### ***P2-910 – P2-916 Transducer 2***

These parameters contain the same information as detailed in Transducer 1 Status, for Transducer 2.



## System Parameters

### Passcode

*P1 and P2*

#### ***P\*921 Enable Code***

Enables the passcode (**P\*922**), which means the passcode must be entered to go into program mode. If **disabled** (set to **0**), then no passcode is required, and ENTER is used to enter program mode. **Default =1 (Enabled)**

#### ***P\*922 Passcode***

This is the passcode that must be used to enter program mode. The **default** is **1997**, but this can be changed to another value from 0 to 9999.

### Backup

*P1 and P2*

#### ***P\*925 Parameter Backup & Restore***

This parameter is used to make a backup of all parameters, for example to ensure a default set is maintained within the unit. If alterations are made to the parameters that do not work as intended, then the backup set can be restored into the unit.

You can make two separate backup copies if you wish, called backup 1 and backup 2, and restore from either.

The options are:

<b>Option</b>	<b>Description</b>
1= Backup 1	Make backup to area 1 of all parameters
2= Backup 2	Make backup to area 2 of all parameters
3= Restore 1	Restore all parameters from area 1
4= Restore 2	Restore all parameters from area 2

## **System Information**

### ***P1 and P2***

*The following three parameters do not affect how the unit performs, but details, contained in them, may be required, by Pulsar, when making technical enquiries.*

### ***P\*926 Software Revision***

This parameter will display the current software revision. It is read only, and cannot be changed. The **software revision** can also be viewed, while in **RUN** mode, by pressing the **decimal point key**.

### ***P\*927 Hardware Revision***

This parameter will display the current hardware revision. It is read only, and cannot be changed.

### ***P\*928 Serial Number***

This parameter will display the serial number of the unit. It is read only, and cannot be changed. The **serial number** can also be viewed, while in **RUN** mode, by pressing the **decimal point key**.

### ***P\*929 Site Identification***

This parameter allows you to give each unit an individual reference number, for identification purposes. You can set any number between 1 and 99999.

### ***P\*930 Factory Defaults***

This parameter resets all parameter values, on both points P1 and P2, to the original Factory Set values that were installed when the unit was tested, before despatch to you.

To **reset** parameters, enter **1 (Yes)**, and press **ENTER**, then you will see a message "**Entr if sure**", you should press **ENTER** again. If you press any other key at this point, the parameters will not be reset, and you will see a message confirming this.

Once you have done this, program the unit, to the desired application.

## **Date & Time**

### ***P1 and P2***

The date and time is used, to control specific relay functions and date stamp certain events that are contained in the Data Logs. It is also used in conjunction with the system watchdog that keeps an eye on the times the unit has started.

### ***P\*931 Date***

This parameter display the **current date**, in the format as set by **P\*933 (Date Format)**, and can be reset if required.

### ***P\*932 Time***

This parameter displays the **current time** and can be reset if required, in the format HH: MM (24-hour format). This is set initially at the factory for UK time.

### ***P\*933 Date Format***

This parameter allows you to alter the format that the date is displayed to your choice of DD: MM: YY, MM: DD: YY or YY: MM: DD. The default is MM:DD: YY.

## **LED Colour**

### ***P1 and P2***

Each relay has an associated LED, located on the unit's front panel, which indicates the status of the relay. By default, the LED of any relay that has been programmed but is in its "OFF" state will be illuminated 'yellow'. When "ON" **alarm** relays will cause the **LED** to illuminate **Red** and **pump, control** and **miscellaneous** relays will cause the **LED** to illuminate **green**. LED's of any relays that have not been programmed will not be illuminated. Customised settings for the colour of LED's can be achieved by using the following parameters.

### ***P\*935 Off Relay Colour***

This parameter selects the colour that a **programmed relay** should be when it is in its "OFF" state. The **default** is **3 = yellow**, but can be changed to 'no colour', red or green.

### ***P\*936 Alarm Relay Colour***

This parameter selects the colour that an **alarm** relay should be when it is in its "ON" state. The **default** is **1 = red**, but can be changed to 'no colour', green or yellow.

### ***P\*937 Pump Relay Colour***

This parameter selects the colour that a **pump** relay should be when it is in its “**ON**” state. The **default** is **2 = green**, but can be changed to ‘no colour’, red or yellow.

### ***P\*938 Control Relay Colour***

This parameter selects the colour that a **control** relay should be when it is in its “**ON**” state. The **default** is **2 = green**, but can be changed to ‘no colour’, red or yellow.

### ***P\*939 Miscellaneous Relay Colour***

This parameter selects the colour that a **miscellaneous** relay should be when it is in its “**ON**” state. The **default** is **2 = green**, but can be changed to ‘no colour’, red or yellow.

All relays that are not programmed will show, ‘no colour’, i.e. they are off.

## **Watchdog**

### ***P1 and P2***

You can check how many times the unit has been switched on, and look at the date and time of the last ten starts. This can be useful if there have been power failures or if for any reason the *Ultra Twin* restarts due to a fault condition. The *Ultra Twin* can be backed up from a battery which automatically cuts in during power failure, battery backed up units will continue uninterrupted operation and therefore will not register a loss of mains power. If, however, the battery was to fail during a mains power interruption, a start-up would be recorded once power has been restored.

The following parameters can be accessed by directly entering the parameter number. To do this, enter the **program mode** and then **type** in the appropriate **parameter number**.

### ***P\*940 Number of Starts***

This parameter shows how many times the unit has been powered up.

### ***P\*941-P\*960 Start Date & Time***

Parameters **P\*941** and **P\*942** show the **date** and **time** that the unit was last started. There are **ten start dates & times** recorded, which are parameters **P\*943-P\*960**. The first on the list are the most recent, and the last ones are the oldest. These are read only, and cannot be changed.

## **Daylight Saving Time**

### ***P1 and P2***

#### **Important Information**

In order to ensure the correct operation of Daylight Saving Time **P\*932 Time** should be checked, and adjusted if necessary, to ensure that it is set for the current valid time.

#### ***P\*970 DST Enable***

When **Enabled** (set to **1**) the internal clock will be automatically adjusted to compensate for the difference between standard time and **Daylight Saving Time**. **Default = 0 (Off)**

#### ***P\*971 DST Difference***

This parameter sets the time difference between standard time and **Daylight Saving Time**. The time difference is entered in HH:MM. **Default = 01:00**

#### ***P\*972 DST Start Time***

This parameter is used to set the **time** of day at which **Daylight Saving Time** will **start**, the time is entered in the format HH: MM (24-hour format). **Default = 02:00**

#### ***P\*973 Start Day***

Use this parameter to enter the **day** of the week (**P\*974**) that **Daylight Saving Time** is to **start**.

<b>Option</b>	<b>Description</b>
2= Monday	<b>DST will start on a Monday</b>
3= Tuesday	<b>DST will start on a Tuesday</b>
4= Wednesday	<b>DST will start on a Wednesday</b>
5= Thursday	<b>DST will start on a Thursday</b>
6= Friday	<b>DST will start on a Friday</b>
7= Saturday	<b>DST will start on a Saturday</b>
<b>8= Sunday (Default)</b>	<b>DST will start on a Sunday</b>

### **P\*974 Start Week**

This parameter will determine the **week** of the month (**P\*975**) in which **Daylight Saving Time** is to **start**.

<b>Option</b>	<b>Description</b>
1= Week 1	<b>DST will start on day (P*973) in the first week (P*974) of the month (P*975).</b>
2= Week 2	<b>DST will start on day (P*973) in the second week (P*974) of the month (P*975).</b>
3= Week 3	<b>DST will start on day (P*973) in the third week (P*974) of the month (P*975).</b>
4= Week 4	<b>DST will start on day (P*973) in the fourth week (P*974) of the month (P*975).</b>
<b>5= Last (Default)</b>	<b>DST will start on day (P*973) in the last week (P*974) of the month (P*975).</b>

### **P\*975 Start Month**

This parameter is used to select the **month**, in which **Daylight Saving Time** will **start**.

<b>Option</b>	<b>Description</b>
1= January	<b>DST will start during the month of January</b>
2= February	<b>DST will start during the month of February</b>
<b>3=March (Default)</b>	<b>DST will start during the month of March</b>
4= April	<b>DST will start during the month of April</b>
5= May	<b>DST will start during the month of May</b>
6= June	<b>DST will start during the month of June</b>
7= July	<b>DST will start during the month of July</b>
8= August	<b>DST will start during the month of August</b>
9= September	<b>DST will start during the month of September</b>
10= October	<b>DST will start during the month of October</b>
11= November	<b>DST will start during the month of November</b>
12= December	<b>DST will start during the month of December</b>

### **P\*976 DST End Time**

This parameter is used to set the **time** of day at which **Daylight Saving Time** will **end** the time is entered in the format HH: MM (24-hour format).  
**Default = 02:00.**

### **P\*977 End Day**

Use this parameter to enter the **day** of the week (**P\*974**) that **Daylight Saving Time** is to **end**.

<b>Option</b>	<b>Description</b>
2= Monday	<b>DST will end on a Monday</b>
3= Tuesday	<b>DST will end on a Tuesday</b>
4= Wednesday	<b>DST will end on a Wednesday</b>
5= Thursday	<b>DST will end on a Thursday</b>
6= Friday	<b>DST will end on a Friday</b>
7= Saturday	<b>DST will end on a Saturday</b>
<b>8= Sunday (Default)</b>	<b>DST will end on a Sunday</b>

### **P\*978 End Week**

This parameter will determine the **week** of the month (**P\*975**) in which **Daylight Saving Time** is to **end**.

<b>Option</b>	<b>Description</b>
1= Week 1	<b>DST will end on day (P*977) in the first week (P*978) of the month (P*979).</b>
2= Week 2	<b>DST will end on day (P*977) in the second week (P*978) of the month (P*979).</b>
3= Week 3	<b>DST will end on day (P*977) in the third week (P*978) of the month (P*979).</b>
4= Week 4	<b>DST will end on day (P*977) in the fourth week (P*978) of the month (P*979).</b>
<b>5= Last (Default)</b>	<b>DST will end on day (P*977) in the last week (P*978) of the month (P*979).</b>

### **P\*979 End Month**

This parameter is used to select the **month**, in which **Daylight Saving Time** will **end**.

<b>Option</b>	<b>Description</b>
1= January	<b>DST will end</b> during the month of <b>January</b>
2= February	<b>DST will end</b> during the month of <b>February</b>
3= March	<b>DST will end</b> during the month of <b>March</b>
4= April	<b>DST will end</b> during the month of <b>April</b>
5= May	<b>DST will end</b> during the month of <b>May</b>
6= June	<b>DST will end</b> during the month of <b>June</b>
7= July	<b>DST will end</b> during the month of <b>July</b>
8= August	<b>DST will end</b> during the month of <b>August</b>
9= September	<b>DST will end</b> during the month of <b>September</b>
<b>10= October (Default)</b>	<b>DST will end</b> during the month of <b>October</b>
11= November	<b>DST will end</b> during the month of <b>November</b>
12= December	<b>DST will end</b> during the month of <b>December</b>

### **Device Comm.**

#### **RS232 Set Up**

*P1 and P2*

##### **P\*061 Comms Baud**

This parameter is used to set the speed (Baud Rate) of the RS232 communications and can be changed to suit the connecting device.  
**Default = 19200**

#### **RS 485 Set Up (Optional)**

*P1 and P2*

Please refer to the relevant communications manual for availability of parameters and details of options.



## **Remote Alarm**

### ***P1 and P2***

When a Modem is connected to, via the RS232 port, (Consult Pulsar or your local distributor for further details), the following parameters are used to set up the *Ultra* Twin so that when the level reaches a specific alarm point, as determined by the setting of the relay(s) the unit will dial and connect to a remote telephone number to provide details of the event.

### ***P\*145 Tel. No.1***

This parameter is used to enter the number of '0's that appear at the beginning of the telephone number to be dialled that is to receive the message.

<b>Option</b>	<b>Description</b>
0= None	No '0's present at the beginning of the telephone number to be dialled.
<b>1 = Add 0 (Default)</b>	1 '0' present at the beginning of the telephone number to be dialled.
2= Add 00	2 '0's present at the beginning of the telephone number to be dialled.

### ***P\*146 Tel. No2***

This parameter is used to enter to enter the next 6 digits, following the '0's, of the telephone number to be dialled. If there are less than 6 digits following the '0's then just enter the digits required, if there are more than 6 digits following the '0's then enter the first 6 digits and then proceed to P\*147 and enter the remaining digits.

### ***P\*147 Tel. No3***

This parameter is used to enter any remaining digits of the telephone number to be dialled after completion of P\*145 and P\*146 above.

### **Example**

Telephone number to be dialled is: 0 1234 123456

P\*145 Tel. No. 1 = 1(One '0' at the beginning of the telephone number)

P\*146 Tel. No. 2 = 123412 (The next 6 digits following the '0's).

P\*147 Tel. No. 3 = 3456 (Remaining digits of telephone number).

## ***P\*148 Call Type***

This parameter determines what type of connection is made via the modem.

<b>Option</b>	<b>Description</b>
<b>0= Off (Default)</b>	Remote alarm function is disabled
1 = Ring	This option initiates a connection to a remote modem/computer which will then allow remote communication with the unit. Please consult Pulsar or your local distributor for further details.
2= SMS	This option initiates a predetermined message which is sent to the remote telephone number detailing date and time the alarm was initiated, the site ID, alarm condition and level at the time the alarm was initiated.

## **Test Parameters**

### **Simulation**

*P1 or P2*

#### ***P1-980, P2-980 Simulate***

Test mode is used to simulate the application and confirm that all parameters and relay setpoints have been entered as expected. During simulation, there is a choice of whether the relays will change state (hard simulation) or not (soft simulation), but the LED's will always change colour as programmed, and the current output will change. If you want to test the logic of the system that the relays are connected to then select a hard simulation, but if you don't want to change the relay state, then select a soft simulation.

There are two simulation modes, automatic and manual. Automatic simulation will move the level up and down between empty level or the pre-determined **Start Level (P1-983, P2-983)** and Pump/Control relay switch points, if you wish to change the direction of the level movement e.g. to go beyond relay setpoints, this can be done by using the arrow keys. In manual simulation, using the arrow keys will allow you to move the level up and down as required.

The choices for you to enter are as follows.

- 1= Manual soft simulation
- 2= Automatic soft simulation
- 3= Manual hard simulation
- 4= Automatic hard simulation

To return to program mode, press CANCEL and test mode will end.

**Note**

Pump start delay (which by default is 10 seconds) is set to 0 during simulation.

## **Test Setup**

### ***P1 and P2***

#### ***P\*981 Increment***

By **default**, simulation mode will move by **0.328 feet** steps in **manual** simulation and by **0.328 feet/min** in **automatic** simulation. Altering the increment can change this value.

#### ***P\*982 Rate***

In automatic mode, the rate at which the level will move up and down, is determined by distance, **P\*981 Increment** and the time, **P\*982 Rate** which by **default** is set to **1min** and can be changed as required. To increase the rate at which the level moves increase the **Increment (P\*981)** or decrease the **Rate (P\*982)**. To decrease the rate at which the level moves decrease the **Increment (P\*981)** or increase the **Rate (P\*982)**.

#### ***P\*983 Start Level***

When using automatic simulation, this parameter can be used to pre-determine the point at which the simulated level will start at and return to. This can be used to simulate the lowest point to which the level would normally operate.

### ***P\*984 Inc. Change***

When using automatic simulation, you can incrementally increase or decrease the rate whilst running simulation. The rate is increased /decreased incrementally by the value **P\*984 (Incremental Change)** by using the “**decimal point**” key to increase and the “**plus/minus**” key to decrease the rate of change. **Default = 0.328 feet**

## **Hardware**

### ***P1 or P2***

#### ***P\*990 Self-Test***

If you enter 1 for this parameter, then the unit will perform a self-test. This will confirm that the various parts of the circuitry are working correctly. You will see confirmation messages that the clock and the EEPROM are working correctly, and error messages for any parts that fail.

#### ***P\*991 Hard Test***

When this parameter is selected, the unit will test the following in turn.

- **LED's.** Watch them change colour as shown on the display, and press, ENTER, if they operated as shown.
- **Relays.** Press a numeric key corresponding to the number of the relay you wish to test, and the relay will change state each time the key is pressed. If you press any other key, other than a valid relay number, then the test will end.
- **Segments.** All the segments on the LCD are lit up, so you can see if they all work. Press, ENTER, to end the test. The LED's all go green at the same time.
- **Keys.** You should press each key, to confirm it works, with a counter showing how many more keys you have to press. Be sure to press the **CANCEL** key last, as this will show if all keys were pressed or not. If they were not, then an error message is displayed.

#### ***P\*992 mA Out Test***

This parameter will allow you to select either mA Output 1 or mA Output 2 and force a specified current on to the output in order to test the equipment that it is connected to the output and to make sure the unit is working correctly. The figure you enter will be generated by the mA output.

### ***P\*994 Transducer Test***

If you enter 1 for this parameter it will continually fire the transducers, so you can check the wiring, until you press any key to cancel.

### ***P\*995 Keys Test***

You should press each key, to confirm it works, with a counter showing how many more keys you have to press. Press the **CANCEL** key last, as this will confirm if all keys were pressed or not. If they were not, then an error message is displayed.

## Chapter 7 Troubleshooting

This section describes many common symptoms, with suggestions as to what to do.

Symptom	What to Do
Display blank, transducer not firing.	Check power supply, voltage selector switch and fuse.
Displays “No Xducer”	Check wiring to transducer.
Displays “Xducer Flt”	There is a fault with the transducer wiring, so check wiring to transducer.
Incorrect reading being displayed for current level.	Measure actual distance from transducer head to surface of material. Enter Program Mode and directly access P21 (Set Distance) type in the measured distance, ENTER, ENTER again when prompted, wait until SET displayed and return to Run Mode, display should now update to correct reading.
Material level is consistently incorrect by the same amount.	Check empty level, (P1-105, P2-105) display offset, (P1-802, P2-802) and measurement offset (P1-851, P2-851).
LED's change colour at relevant relay switch points but relays do not change state.	Check supply to unit and ensure voltage selector set to correct position.

Incorrect disposal can cause adverse effects to the environment.

Dispose of the device components and packaging material in accordance with regional environmental regulations including regulations for electrical \ electronic products.

### **Transducers**

Remove power, disconnect the Transducer, cut off the electrical cable and dispose of cable and Transducer in accordance with regional environmental regulations for electrical \ electronic products.

### **Controllers**

Remove power, disconnect the Controller and remove battery (if fitted). Dispose of Controller in accordance with regional environmental regulations for electrical \ electronic products.

Dispose of batteries in accordance with regional environmental regulations for batteries.



 EU WEEE Directive Logo

This symbol indicates the requirements of Directive 2012/19/EU regarding the treatment and disposal of waste from electric and electronic equipment.





