

# **APLISENS**





**MANUFACTURE OF PRESSURE TRANSMITTERS  
AND CONTROL INSTRUMENTS**

## **USER'S MANUAL**

**SMART LEVEL PROBES TYPE:  
SGE-25.SMART; SGE-25S.SMART,  
SGE-25C.SMART, SGE-25S.SMART/TYTAN  
HYDROSTATIC LEVEL PROBES  
SGE-25; SGE-25S; SGE-25C; SGE-16.**

**WARSAW JULY 2011**

## Symbols used

Symbol	Description
	Warning to proceed strictly in accordance with the information contained in the documentation in order to ensure the safety and full functionality of the device.
	Information particularly useful during installation and operation of the device.
	Information particularly useful during installation and operation of a type Ex device.
	Information on disposal of used equipment

## **BASIC REQUIREMENTS AND SAFE USE**



- **The manufacturer will not be liable for damage resulting from incorrect installation, failure to maintain the device in a suitable technical condition, or use of the device other than for its intended purpose.**

- Installation should be carried out by qualified staff having the required authorizations to install electrical and pressure-measuring devices. The installer is responsible for performing the installation in accordance with these instructions and with the electromagnetic compatibility and safety regulations and standards applicable to the type of installation.

- The device should be configured appropriately for the purpose for which it is to be used. Incorrect configuration may cause erroneous functioning, leading to damage to the device or an accident.

- If a device is not functioning correctly, disconnect it and send it for repair to the manufacturer or to a firm authorized by the manufacturer



In order to minimize the risk of malfunction and associated risks to staff, the device is not to be installed or used in particularly unfavourable conditions, where the following dangers occur:

- possibility of mechanical impacts, excessive shocks and vibration;

- excessive temperature fluctuation, exposure to direct sunlight;

- condensation of water vapour, dust, icing.



Installation of intrinsic safety versions should be performed with particular care, in accordance with the regulations and standards applicable to that type of installation.

Changes to the products manufacturing documentation may forestall a paper user updating. Current Instruction Manual is available at Producer [http. on www.aplisens.pl](http://www.aplisens.pl).

## CONTENTS.

<b>I. APPENDIX EX.03 (SGE–25.SMART, SGE–25S.SMART, SGE–25C.SMART)</b> .....	<b>2</b>
<b>II. APPENDIX EX.04 (SGE–25, SGE–25S, SGE–25C)</b> .....	<b>4</b>
<b>1. INTRODUCTION</b> .....	<b>6</b>
<b>2. USER MATERIALS</b> .....	<b>6</b>
<b>3. APPLICATIONS OF PROBES</b> .....	<b>6</b>
<b>4. IDENTIFYING MARKS. ORDERING PROCEDURE</b> .....	<b>6</b>
<b>5. TECHNICAL DATA</b> .....	<b>7</b>
<u>5.1. TECHNICAL DATA. SGE-25.SMART, SGE-25S.SMART, SGE-25C.SMART, SGE-25S.SMART/TYTRAN PROBES</u> .....	7
<u>5.2. TECHNICAL PARAMETERS OF THE SGE-25</u> .....	8
<u>5.3. TECHNICAL PARAMETERS OF THE SGE-25S</u> .....	9
<u>5.4. TECHNICAL PARAMETERS OF THE SGE-25C</u> .....	9
<u>5.5. TECHNICAL PARAMETERS OF THE SGE-16</u> .....	9
<u>5.6. SGE-25, SGE-16, SGE-25S, SGE-25C. ELECTRICAL PARAMETERS</u> .....	9
<u>5.7. SGE-25, SGE-25S, SGE-25C, SGE-16 PROBES WITH CABLE IN VERSION THREE WIRES; WITH VOLTAGE OUTPUT SIGNALS, OR LOW VOLTAGE OUTPUT SIGNALS ("NN"). TECHNICAL PARAMETERS</u> .....	10
<u>5.8. CONSTRUCTION MATERIALS: (FOR WHOLE PROBES)</u> .....	10
<u>5.9. INGRESS PROTECTION RATING:</u> .....	10
<b>6. TECHNICAL DESCRIPTION</b> .....	<b>10</b>
<u>6.1. PRINCIPLES OF OPERATION</u> .....	10
<u>6.2. CONSTRUCTION</u> .....	10
<u>6.3. ELECTRONIC CIRCUIT OF THE PROBES</u> .....	11
<b>7. PLACE OF INSTALLATION</b> .....	<b>11</b>
<u>7.2. HIGH AND LOW AMBIENT TEMPERATURES AND MEDIUM TEMPERATURES</u> .....	11
<b>8. INSTALLATION AND CONNECTION</b> .....	<b>11</b>
<u>8.1. MECHANICAL INSTALLATION</u> .....	11
<u>8.2. ELECTRICAL CONNECTION</u> .....	11
<b>9. SETTINGS AND REGULATION</b> .....	<b>12</b>
<u>9.1. SETTINGS OF SGE-25, SGE-16, SG-25C AND SGE-25S PROBES</u> .....	12
<u>9.2. SETTINGS OF SGE-25.SMART, SGE-25S.SMART PROBES</u> .....	12
<u>9.3. SGE-25.SMART, SGE-25S.SMART. MEASUREMENT RANGES. DEFINITIONS</u> .....	12
<u>9.4. CONFIGURATION AND CALIBRATION</u> .....	12
<b>10. INSPECTIONS, REPAIRS AND SPARE PARTS</b> .....	<b>13</b>
<u>10.1. REGULAR INSPECTIONS</u> .....	13
<u>10.2. ADDITIONAL INSPECTIONS</u> .....	13
<u>10.3. SPARE PARTS</u> .....	14
<b>11. PACKING, STORAGE AND TRANSPORT</b> .....	<b>14</b>
<u>11.1. PACKING, TRANSPORT</u> .....	14
<u>11.2. STORAGE</u> .....	14
<b>12. GUARANTEE</b> .....	<b>14</b>
<b>13. ADDITIONAL INFORMATION</b> .....	<b>14</b>
<b>14. FIGURES</b> .....	<b>15</b>
FIGURE 1 SGE-25.SMART AND SGE-25S.SMART PROBES – DIMENSIONS.....	15
FIGURE 2. SGE-25.SMART AND SGE-25S.SMART PROBES – CONNECTION METHOD.....	15
FIGURE 3. SGE-25, SGE-16,SGE-25C AND SGE-25S PROBES – DIMENSIONS.....	16
FIGURE 3A. CONNECTION OF SGE-25, SGE-25S AND SGE-25C IN A THREE-WIRE SYSTEM (0...10V OUTPUT SIGNAL) .....	16
FIGURE 3B. CONNECTION OF SGE-25, SGE-16, SGE-25S AND SG-25C IN A TWO-WIRE SYSTEM (4...20MA OUTPUT SIGNAL) .....	16
FIGURE 4. THE PROBE IN EX-VERSION WITH A CABLE WITH AN TEFLON SHIELD. ....	17

# I. APPENDIX Ex.03 (SGE-25.SMART, SGE-25S.SMART, SGE-25C.SMART)



SMART LEVEL PROBES  
type: SGE-25.SMART, SGE-25S.SMART, SGE-25C.SMART  
Ex VERSIONS

## 1. Introduction

- 1.1 This "Appendix Ex.03" applies only to smart level probes SGE-25.SMART, SGE-25S.SMART, SGE-25C.SMART in Ex versions, marked on the rating plate as shown in 2.2 and denoted Ex in the Product Certificate.
- 1.2 The appendix contains supplementary information relating to the Ex versions of the SGE-25.SMART, SGE-25S.SMART, SGE-25C.SMART probes. During installation and use of ex probes reference should be made to DTR.SG...05 in conjunction with "Appendix Ex.03".

## 2. Use of SGE-25.SMART probes in danger zones

- 2.1. The probes are produced in accordance with the requirements of the following standards: EN 60079-0:2009, EN 50303:2000, EN 60079-26:2007, EN 60079-11:2007
- 2.2. The probes may operate in areas where there is a risk of explosion, in accordance with the rating of the explosion protection design:



II 1G Ex ia IIC T4/T5/T6 Ga  
II 1G Ex ia IIB T4/T5/T6 Ga (for probe with teflon-shielded cable)  
I M1 Ex ia I Ma  
KDB 11ATEX140X

## 3. Identifying marks

The above mentioned probes in Ex-version, must have a rating plate containing the information specified in paragraph 4 of DTR. SG...05, and also at least the following:

- CE mark and number of notified unit: 1453 in the case of GIG KDB, mark
- designation of explosion protection design, certificate number,
- values of parameters such as Ui, li, Ci,
- year of manufacture,
- inscription: " Version Exi SA "- for probes with the protection against overvoltage (surge arrester)

## 4. User information.

Together with the probes ordered, the user will receive: User's Manual numbered DTR.SG...05 with Appendix Ex, and also the Product Certificate.

## 5. Permitted input parameters of the SGE-25.SMART, SGE-25S.SMART, SGE-25C.SMART probes. (based on data from the KDB 11ATEX140X certificate and certification documentation.)

-Permitted input parameters for power supply with a linear characteristic.

$$U_i = 28V \text{ DC} \quad I_i = 0,1A$$

-Permitted input parameters for power supply with a "rectangular" characteristic and trapezoidal characteristic

$$U_i = 24V \text{ DC} \quad I_i = 0,05A$$

$P_i$  for all type of power supply see table.

$P_i$ [W]	$T_a$ [°C]	Temperature class
0,7	60	T6
	80	T5, T4, group I
1,2	50	T6
	70	T5
	80	T4, group I

$T_a$  – ambient temperature (temperature of measuring medium)

Input inductance and capacity:  $C_i = 11nF$ ,  $L_i = 1,0mH$

### 5.1. Special conditions for safe use:

Version of device with surge arrester, marked on the plate "Exi SA", does not meet the 500V rms isolation test required by EN-60079-11:2007. This must be taken into account when installing the equipment.

## 6. Supply examples.

Power supply with a “linear” characteristic may be e.g. a typical barrier with parameters:  
 $U_o=28V$   $I_o=0.093A$   $R_w=300\Omega$ .

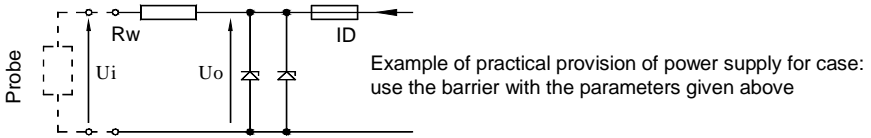

Fig.1. Power supply from a source with linear characteristic”

Example of power supply from a source with trapezoidal characteristic (see Fig.2).

$U_o=24V$   $I_o=0,05A$

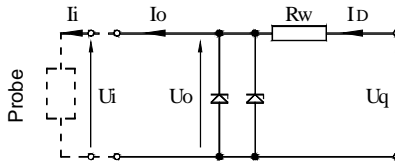

Fig. 2. Power supply from a source with trapezoidal characteristic

$$\text{If } U_o < \frac{1}{2} U_q \text{ then } U_q = \frac{4P_o}{I_i}, \quad R_w = \frac{U_q}{I_o}, \quad P_o = \frac{U_o(U_q - U_o)}{R_w}$$

For power supply with rectangular characteristic:

Supplementary attentions:

The supply of power from a source with a rectangular characteristic means that the voltage of the Ex power supply remains constant until current limitation activates.

The protection level of power supplies with a “rectangular” characteristic is normally “ib”.

The probe powered from such a supply is also a Ex device with protection level “ib”.

Example of practical provision of power supply with a rectangular characteristic:

use a stabilized power supply with  $U_o=24V$  with protection level „ib” and current limited to  $25mA < I_o < 30mA$

### 6.1. The protection level

The probe is Ex device with protection level „ia” when the powered circuit have protection level „ia”.

The probe is Ex device with protection level „ib” when the powered circuit have protection level „ib”.

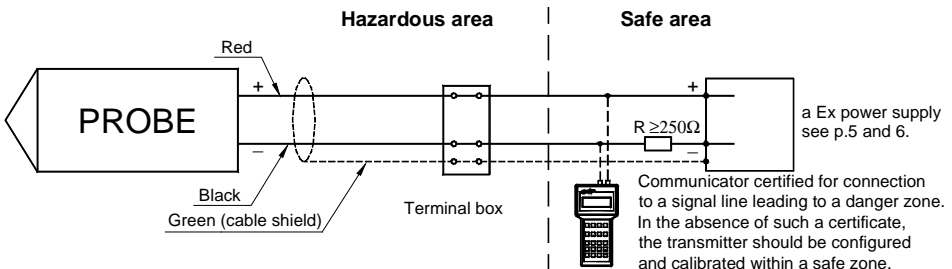

Fig.3. SGE–25.SMART, SGE–25S.SMART, SGE–25C.SMART probes in Ex version – connection method



**Devices in the measurement loop of the probe should be connected in accordance with Intrinsic safety and explosion protection standards.**



**It is not permitted to repair or otherwise interfere with the probe’s electrical circuits in any way. Damage and possible repair may be assessed only by the manufacturer or another authorized party.**

## II. APPENDIX Ex.04 (SGE–25, SGE–25S, SGE–25C)

DTR.SG...05. Appendix Ex.04(ENG)  
(SGE–25, SGE–25S, SGE–25C)



HYDROSTATIC LEVEL PROBES type: SGE–25, SGE–25S, SGE–25C  
Ex VERSIONS

### 1. Introduction

- 1.1 This "Appendix Ex.04" applies only to hydrostatic level probes SGE-25, SGE-25C and SGE-25S in Ex versions, marked on the rating plate as shown in 2.2 and denoted Ex in the Product Certificate.
- 1.2 The appendix contains supplementary information relating to the Ex versions of the SGE–25, SGE–25C, SGE–25S probes. During installation and use of Ex probes reference should be made to DTR.SG...05 in conjunction with "Appendix Ex.04".

### 2. Use of probes in danger zones

- 2.1. The probes SGE–25, SGE–25S are produced in accordance with the requirements of the following standards: EN 60079-0:2006, EN 50303:2004, EN 60079-26:2007, EN 60079-11:2007
- 2.2. The probes may operate in areas where there is a risk of explosion, in accordance with the rating of the explosion protection design:

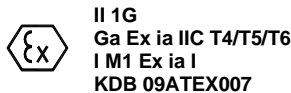

### 3. Identifying marks

The above mentioned probes in Ex-version, must have a rating plate containing the information specified in paragraph 4 of DTR. SG...05, and also at least the following:

- CE mark and number of notified unit: 1453 in the case of GIG KDB, mark
- designation of explosion protection design, certificate number,
- values of parameters such as Ui, li, Ci,
- year of manufacture

### 4. User information.

Together with the probes ordered, the user will receive: User's Manual numbered DTR.SG...05 with Appendix Ex.04, and also the Product Certificate.

### 5. Permitted input parameters of the SGE–25, SGE–25S, SGE–25C probes (based on data from the KDB 09ATEX007 certificates, and certification documentation.)

-permitted input parameters for power supply with a linear characteristic.

$$U_i = 28V \text{ DC} \quad I_i = 0,1A$$

-permitted input parameters for power supply with a "rectangular" characteristic and "trapezoidal" characteristic

$$U_i = 28V \text{ DC} \quad I_i = 0,08A$$

Input inductance and capacity:  $C_i = 30nF, I_i = 750\mu H$

$P_i$  for all type of power supply see table.

$P_i$ [W]	$T_p$ [°C]	Temperature class	$P_i$ [W]	$T_p$ [°C]	Temperature class
1,8	53	T6	1,3	60	T6
	68	T5		75	T5, T4, group I
	75	T4, group I		65	T6
1,6	56	T6	1,0	75	T5,T4, group I
	71	T5		69	T6
	75	T4, group I	0,7	75	T5,T4, group I

$T_p = T_m$   
 $T_p = T_a$

- for  $T_m > T_a$   
- for  $T_m < T_a$

$T_m$  – temperature of measuring medium  
 $T_a$  – ambient temperature

## 6. Supply examples

Power supply with a linear characteristic may be e.g. a typical barrier with parameters:

$$U_o=28V \quad I_o=0.093A \quad R_w=300\Omega.$$

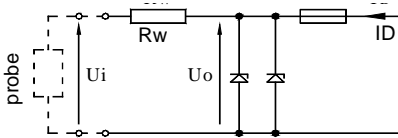

Example of practical provision of power supply for case: use the barrier with the parameters given above

Fig.1. Power supply from a source with linear characteristic"

Example of power supply from a source with trapezoidal characteristic (see Fig.2).

$$U_o=28V \quad I_o=0,08A$$

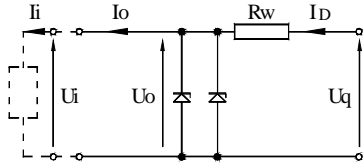

Fig. 2. Power supply from a source with trapezoidal characteristic"

$$\text{If } U_o < \frac{1}{2} U_q \quad \text{then} \quad U_q = \frac{4P_i}{I_o}, \quad R_w = \frac{U_q}{I_o}, \quad P_o = \frac{U_o(U_q - U_o)}{R_w}$$

For power supply with rectangular characteristic:

The supply of power from a source with a rectangular characteristic means that the voltage of the Ex power supply remains constant until current limitation activates.

The protection level of power supplies with a "rectangular" characteristic is normally "ib".

The probe powered from such a supply is also a Ex device with protection level "ib".

Example of practical provision of power supply with a "rectangular" characteristic:

– use a stabilized power supply with  $U_o=24V$  with protection level „ib" and current limited to  $I_o=50mA$ .

### 6.1. The protection level

The probe is Ex device with protection level „ia" when the powered circuit have protection level „ia".

The probe is Ex device with protection level „ib" when the powered circuit have protection level „ib".

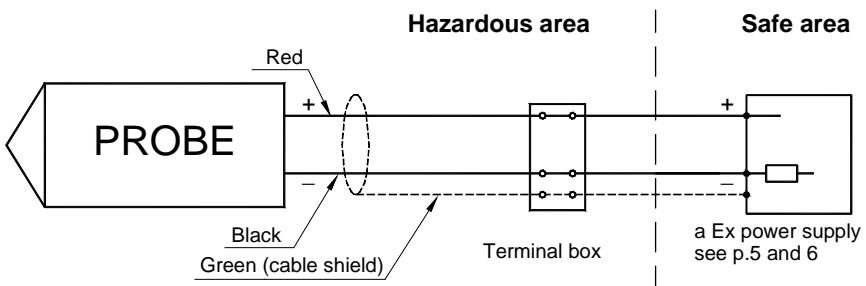

Fig.3. SGE-25, SGE-25S, SGE-25C probes in Ex version – connection method



**Devices in the measurement loop of the probe should be connected in accordance with intrinsic safety and explosion protection standards.**



**It is not permitted to repair or otherwise interfere with the probe's electrical circuits in any way. Damage and possible repair may be assessed only by the manufacturer or another authorized party**

## 1. INTRODUCTION

1.1. This manual is intended for users of **SGE-25.SMART**, **SGE-25S.SMART**, **SGE-25C.SMART**, **SGE-25S.SMART/TYTAN**, **SGE-25**, **SGE-25S**, **SGE-25C** and **SGE-16** hydrostatic level probes containing the data and guidelines necessary to understand the functioning of the probes and how to operate them. It includes essential recommendations concerning installation and use, as well as emergency procedures. SG probes have two version of output electrical signals: 4 – 20mA in two wire cable and voltage output signals with cable in version three wires (see p.5.7.3.).

1.2. The **SGE-25**, **SGE-25S**, **SGE-25C** and **SGE-25SMART**, **SGE-25S.SMART**, **SGE-25C.SMART** are also made in Ex version.



Additional data on the probes in Ex version is contained in the appendix designated „DTR.SG...05(ENG). Appendix.Ex.04” or „DTR.SG...05(ENG). Appendix.Ex.03”.

During installation and use of the probes in Ex version, reference should be made to **DTR.SG...05** in conjunction with **Appendix Ex**.

1.3. The level probes: **SGE-25**, **SGE-25S**, **SGE-25C**, **SGE-25SMART**, **SGE-25S.SMART**, **SGE-25C.SMART** in realization for sea uses are complied with Det Norske Veritas (DNV) Rules for Classification of Ships, High Speed & Light Craft and Det Norske Veritas' Offshore Standards. Certificate **No. A -11311** for application in following Location Classes: Temperature **C**, Humidity: **B**, Vibrations: **B**, EMC: **B**, Enclosure: **D** (see Standard for Certification no 2.4)



## 2. USER MATERIALS

The level probes are delivered in single and/or multiple packs.

Together with the probe are delivered:

- Product certificate, which is also as the warranty card
- Declaration of conformity - on request,
- Copy of ATEX certificate – on request
- User's Manual numbered „DTR.APT.SG...05(ENG)”.

Items b), c), d) are available at: [www.aplisens.pl](http://www.aplisens.pl)

## 3. APPLICATIONS OF PROBES

The **SGE-25.SMART**, **SGE-25S.SMART**, **SGE-25C.SMART**, **SGE-25S.SMART/TYTAN**, **SGE-25**, **SGE-25S**, **SGE-25C** and **SGE-16** probes are designed to measure the depth of liquid in wells, swimming pools, watercourses, boreholes etc.

The **SGE-25S.SMART** and **SGE-25S**, probes are also designed for the measurement of levels of liquid waste and of dense or viscous.

The **SGE-16** probe, due to its small diameter, is designed for the measurement of water levels in wells and boreholes, wherever it is necessary to insert probes into pipes of small diameter for which it is impossible to use the **SGE-25**.

The probes convert an input pressure (being a measure of the level of the medium) into a standard 4÷20 mA signal transmitted in a two-wire system (probes **SGE-25**, **SGE-16**, **SGE-25C**, **SGE-25S**) and a digital communication signal in the „HART” system (probes **SGE-25.SMART**, **SGE-25S.SMART**, **SGE-25C.SMART**, **SGE-25S.SMART/TYTAN**), or in special versions into a 0÷10V signal transmitted in a three-wire system (applicable only to the **SGE-25**, **SGE-25S**, **SGE-25C**, **SGE-16** models).

Probes fitted with cables with an additional Teflon shield may be used with food products and with reactive substances.

## 4. IDENTIFYING MARKS. ORDERING PROCEDURE

### 4.1. Identifying marks on a rating plate

Every probe carries a rating plate containing at least the following information: CE mark, numbers of notified institutions and designations of certificates obtained, name of manufacturer, type, factory number, basic range, output signal, power supply voltage.

Probes for marine uses are equipped in additional rating plates with the DNV certificate number, and signs of environmental classes.

### 4.2. Ordering procedure

See the catalogue cards.



## 5. TECHNICAL DATA

### **5.1. Technical data. SGE-25.SMART, SGE-25S.SMART, SGE-25C.SMART, SGE-25S.SMART/TYTAN probes**

#### **5.1.1. SGE-25.SMART, SGE-25S.SMART . Measurement Ranges**

Type of probe	Basic range (FSO)	Maximum range (measurement limits)	Minimum set range	Ability to shift the start of the range	Overpressure limit (without hysteresis)
SGE-25.SMART	0÷10 m H <sub>2</sub> O	-1÷11,5 m H <sub>2</sub> O	0,8 m H <sub>2</sub> O	0÷10 m H <sub>2</sub> O	100 m H <sub>2</sub> O
SGE-25S.SMART	0÷100 m H <sub>2</sub> O	-5÷115 m H <sub>2</sub> O	8 m H <sub>2</sub> O	0÷100 m H <sub>2</sub> O	700 m H <sub>2</sub> O

#### **SG-25C.SMART Measurement ranges:**

0÷2, 0÷4, 0÷10 mH<sub>2</sub>O

Overpressure limit 10 x range

#### **SG-25S.SMART/TYTAN Measurement ranges:**

Basic range 0÷16 mH<sub>2</sub>O

Minimum set range 1,6 mH<sub>2</sub>O

#### **5.1.2. SGE-25.SMART. Metrological parameters.**

Accuracy	≤ ± 0,1 % for the basic range ≤ ± 0,3 % for the minimum set range
Long term stability	≤ 0,1 % (FSO) for 2 years.
Thermal error	< ± 0,08 % (FSO) / 10° C < ± 0,2 % for the whole thermal compensation range
Thermal compensation range	-25 ÷ 80° C
Error due to supply voltage changes	0,002% (FSO) / 1V

#### **5.1.3. SGE-25S.SMART. Metrological parameters.**

Accuracy	≤ ± 0,16 % for the basic range ≤ ± 0,4 % for the minimum set range
Thermal error	< ± 0,08 % (FSO) / 10° C < ± 0,2 % for the whole thermal compensation range.
Additional absolute zero error related to changes in the medium temperature	up to 80 Pa/10° C
Thermal compensation range	-25 ÷ 80° C
Error due to supply voltage changes	0,002% (FSO) / 1V

#### **5.1.4. SGE-25C.SMART. Metrological parameters.**

Accuracy	1%
Thermal error of zero	≤0,6%/10°C
Thermal error of span	≤0,4%/10°C
Hysteresis, repeatability	0,05%

#### **5.1.5. SGE-25S.SMART/TYTAN. Metrological parameters.**

Accuracy	≤0,2% for the basic range
Thermal error	≤0,4%/10°C for the basic range
Thermal error	≤0,3%/10°C for the whole thermal compensation range

### 5.1.6. SGE-25.SMART, SGE-25S.SMART. Electrical parameters

Power supply for normal-version 10,5...36 V DC



Power supply for Ex-version see "Appendix Ex.03 SGE-25.SMART, SGE-25S.SMART"

Output signal	4...20 mA or inverse 20...4 mA two wire transmission
Load resistance	$R[\Omega] \leq \frac{U_{sup} [V] - 10,5 V}{0,0225 A}$
Communication	Communication take place via a 4..20 mA signal using specialized APLISENS equipment, (see 9).
Resistance required for communication	250...1100 $\Omega$
Minimum supply voltage for specified load resistance $R_L[\Omega]$	$U_{min.}[V] = R_L[\Omega] \times 0,02 A + 10,5 V$
Damping of the sensing module	0,3 s
Damping added electronically	0...30 s
Voltage for insulation testing	
– normal version	500 V AC or 750 V DC
– "Exi S.A." version	100 V DC
Excess voltage protection	see. 10.2.3.

### 5.1.7. SGE-25.SMART and SGE-25S.SMART. Permitted Environmental Conditions.

Process temperature limit	-30...80° C – for the basic range 0...10 m H <sub>2</sub> O
	-30...50° C – for the basic range 0...100 m H <sub>2</sub> O



Maximum process temperature for Ex-version see "Appendix Ex.03 SGE-25.SMART, SGE-25S.SMART"



The medium must not be allowed to freeze in the immediate vicinity of the probe.

### 5.2. Technical Parameters of the SGE-25

Any measurement range	1...500 m H <sub>2</sub> O for normal version
	1...100 m H <sub>2</sub> O for Ex version
Recommended standard ranges	4, 10, 20, 50, 100 m H <sub>2</sub> O

	Measurement Range		
	1m H <sub>2</sub> O	4m H <sub>2</sub> O	0...10m H <sub>2</sub> O ÷ 500m H <sub>2</sub> O
Overpressure Limit (repeatable–without hysteresis)	40 x range	25 x range	10 x range(max. 700 m H <sub>2</sub> O)
Accuracy	0,6%	0,3 %	0,2 %
Thermal error	typical 0,3% / 10° C max 0,4% / 10° C		typical 0,2% / 10° C max 0,3% / 10° C

Special version with increased accuracy (SGE-25 level probe, measurement range 0..10 m H<sub>2</sub>O, accuracy – 0,1%, Total error at 0...25° C – 0,3%.)

Hysteresis, repeatability	0,05%
Long term stability	0,1% or 1 cm H <sub>2</sub> O for 1 year
Thermal compensation range	0 ÷ 25° C – standard, -10 ÷ 70° C – for special version
Process temperature limit	-25 ÷ 50° C – for ranges > 20m H <sub>2</sub> O, -25 ÷ 75° C – for ranges ≤ 20m H <sub>2</sub> O,



Maximum process temperature for Ex-version see "Appendix Ex.04 SGE-25, SGE-25S".



The medium must not be allowed to freeze in the immediate vicinity of the probe.

### **5.3. Technical Parameters of the SGE-25S.**

Any measurement range 2...20 m H<sub>2</sub>O for normal and Ex-version.  
 Recommended standard ranges 2, 4, 10 m H<sub>2</sub>O

	Measurement Range		
	2m H <sub>2</sub> O	4m H <sub>2</sub> O	0...10m H <sub>2</sub> O ±20m H <sub>2</sub> O
Overpressure Limit (repeatable–without hysteresis)	20 x range	20 x range	10 x range
Accuracy	1,5%	1%	0,5%
Thermal error of zero	typical 0,4% / 10° C max 0,6% / 10° C		typical 0,2% / 10° C max 0,3% / 10° C
Thermal error of span	typical 0,3% / 10° C max 0,4% / 10° C		typical 0,2% / 10° C max 0,3% / 10° C

Hysteresis, repeatability 0,05%  
 Thermal compensation range 0 ÷ 25° C – standard  
 Process temperature limit -25 ÷ 75° C



**Maximum process temperature for Ex-version see “Appendix Ex.04 SGE–25, SGE–25S”.**



**The medium must not be allowed to freeze in the immediate vicinity of the probe.**

### **5.4. Technical Parameters of the SGE-25C**

Measurement ranges 0...2; 0...4; 0...10 m H<sub>2</sub>O  
 Accuracy 1%  
 Hysteresis, repeatability 0,05%  
 Overpressure limit (repeatable – without hysteresis) 10 x range  
 Thermal error of zero 0,6% / 10° C  
 Thermal error of span 0,4% / 10° C  
 Process temperature limit -25 ÷ 75° C  
 Thermal compensation range 0 ÷ 25° C

### **5.5. Technical Parameters of the SGE-16**

Measurement ranges 10; 20; 50; 100m H<sub>2</sub>O  
 Accuracy 0,5%  
 Hysteresis, repeatability 0,05%  
 Overpressure limit (repeatable – without hysteresis) 2 x range  
 Process temperature limit 0 ÷ 50° C  
 Thermal compensation range 0 ÷ 25° C

### **5.6. SGE-25, SGE-16, SGE-25S, SGE-25C. Electrical parameters**

Output signal 4 ÷ 20mA, two wire transmission  
 Load resistance  $R[\Omega] \leq \frac{U_{sup} [V] - 10,5 V}{0,02 A}$   
 (for current output)  
 Power supply for normal-version 10,5 ÷ 36V DC for 4...20mA output



**Power supply for Ex-version see “Appendix Ex.04 SGE–25, SGE–25S”**

## **5.7. SGE-25, SGE-25S, SGE-25C, SGE-16 probes with cable in version three wires; with voltage output signals, or low voltage output signals ("NN").**

### **Technical Parameters**

**5.7.1. Ranges and metrological parameters in accordance with the data according to points 5.1 to 5.5 as for the probes in a two-wire version**

#### **5.7.2. Electrical parameters**

**For SGE-25, SGE-25S, SGE-25C**

Supply voltage	12 ÷ 30V DC
Output signal	0 ÷ 10V
Load resistance	$R \geq 20 \text{ k}\Omega$
Current consumption	to 3 mA

#### **5.7.3. Electrical parameters**

**For SGE-25, SGE-25S, SGE-25C, SGE-16**

low voltage version ("NN")

Supply voltage	3,1 ÷ 14,1V DC
Output signals:	0 ÷ 2V, 0 ÷ 2,5V, 0 ÷ 3,3V, 0,5 ÷ 4,5V, 0 ÷ 5V, 0 ÷ 10V

Other output signals can be negotiated; by reconciling the output signal should be used dependence:

$$U_{outmax} \leq U_{supl} - 1,5V$$

Rezystancja obciążenia  $R \geq 20 \text{ k}\Omega$

Time constants in the standard implementation of about 20 ms

Other values of time constants up to 0.5 seconds after agreement

## **5.8. Construction Materials: (for whole probes).**

Diaphragm:	Stainless steel 316L (00H17N14M2)-for SGE-16, SGE-25S, SGE-25S.SMART
Diaphragm:	Hastelloy C276 – for SGE-25, SGE-25.SMART, SGE-25C
Sensing module:	Stainless steel 316L (00H17N14M2)
Casing for electronic parts:	Steel pipe, 316L (00H17N14M2)
Liquid filling the interior of the sensing module:	Silicone oil
Cable shield:	polyurethane
Additional cable shield:	Teflon (fitted by arrangement)

## **5.9. Ingress protection rating:**

SGE-25.SMART, SGE-25S.SMART, SGE-25, SGE-25S, SGE-25C and SGE-16 IP68

## **6. TECHNICAL DESCRIPTION.**

### **6.1. Principles of Operation**

The hydrostatic level probes work by converting changes in the resistance of a piezoresistive bridge, while are proportional to the pressure (of a hydrostatic column of liquid), into a standard current output signal. The active sensing device is a silicon diaphragm with in-diffused piezoresistors. The (non-uniformized) electrical signal obtained from the piezoresistive bridge is proportional to the input pressure (depth) and is converted by the electronic circuit into an output signal.

### **6.2. Construction.**

**6.2.1.** The probes are in the shape of a hermetically closed cigar, containing the active sensing device with silicon and sealing diaphragm, as well as a plate with the electronic components.

The **SGE-25S.SMART** and **SGE-25S** probes additionally fitted with a diaphragm seal enabling depth measurements to be carried out on dense media and media with suspended matter and impurities, such as liquid waste (fig. 1, 3).

The output signal is passed through a special cable with a capillary used to connect the negative side of the measuring diaphragm to the atmosphere. All metal parts of the probes are made of 00H17N14M2 stainless steel (316L), and Hastelloy C276 (see section 5.7.), and the cable has a polyurethane shield.

**6.2.2.** Special versions of the probes can be produced with cables shielded by an additional teflon layer.

The shield covers the parts of the cable while is immersed in the medium being measured, as well as a necessary additional segment.

The Teflon shield (in Ex version) is additional equipped in stainless steel cord escorted electrostatic charges (see fig. 4.).

**6.2.3.** The probes are fitted with elements ensuring excess voltage protection: „transil” diodes between the wires, and plasma surge arresters between the wires and the casing. The plasma surge arresters are assembled in normal and "Exi SA" only.

### **6.3. Electronic circuit of the probes**

Electronic circuit can be produced in two versions:

#### **6.3.1. The digital version (SGE-25.SMART and SGE-25S.SMART probes).**

The electronic circuit changes the signal from the sensing module into digital signal and input to a microprocessor, which controls the probe's operation. Using data input during the production process, the processor processes the conversion curve, adjusts for thermal errors and carries out linearization. After processing, the digital signal is again converted into an analogue 4÷20mA current signal, with a superimposed digital communication signal.

For communication with the probe via the signal line a special Aplisens communicator KAP is used.

#### **6.3.2. The analog version (SGE-25, SGE-25S, SGE-25C and SGE-16 probes).**

The electronic circuit changes the signal from the sensing module into an output signal 4...20 mA.

The electronic circuit is equipped in filter elements assured resistance on conducted and radiated disturbances and electric impulse.

The electronics board is hermetically flooded hardenable silicone resin in the stainless steel casing.

## **7. PLACE OF INSTALLATION**

**7.1.** The level probes installed in places where liquid levels are measured in wells, swimming pools, tanks, boreholes etc. The probe is immersed in the medium being measured. A special cable extends above the level of the medium; this can be connected directly to another device or to a terminal box.

### **7.2. High and Low Ambient Temperatures and Medium Temperatures.**

When measuring liquids whose solidification point is above the ambient temperature, the medium should not be allowed to freeze around the probe, this applies in particular to water in the case of open-air installations. For maximum medium temperatures see sect. 5.



**Data for versions Ex in accordance with Appendix Ex.03, Appendix Ex.04.**

## **8. INSTALLATION AND CONNECTION**

### **8.1. Mechanical Installation**

The probe can be suspended from the power supply cable, but where there is a danger that it may catch on protruding elements it is recommended that the probe be suspended on a steel cable using the supporting handle (not applicable to **SGE-16**). If the cable is to be exposed to current or turbulence, it should be installed in a protective tube, e.g. one made from PCV.



**Directly before location the probe in measured medium to take off from diaphragm seals SGE-25S, SGE-25S.SMART, SGE-25C the securing cover.**

**Protect the level probe from impacts during installation.**



The probe with an additional Teflon shield suspend on a steel cable or on a internal cable (do not catch for teflon).

The probe in Ex-version with a cord for earthing suspend on a steel cable using the lifting handle

### **8.2. Electrical Connection.**

The method of making electrical connections is shown in figure 2, 3A, 3B (for Ex version in figure 3 „Appendix Ex”).

If the transmission line leads to remote premises via the open air, it is recommended that a terminal box, be fitted, e. g. the Aplisens type PP, in order to connect the probe's cable to the remaining section of the transmission line. The box should have an IP65 ingress protection rating, and but should not be so airtight as to prevent the probe's active sensing device from "breathing" via a capillary embedded in the cable.

The opening of the capillary should not be allowed to become dirty, and water should not be allowed to enter the capillary.

Where the transmission line is very long, it is recommended that the section leading from the end of the probe cable be made from twisted pair cable, and it is desirable that entry points to other devices be fitted with excess voltage protection, e. g. the Aplisens UZ-2 system.

The cable of the probe and the remaining section of the transmission line should be protected from mechanical damage.

## 9. SETTINGS AND REGULATION.

### 9.1. Settings of SGE-25, SGE-16, SG-25C and SGE-25S probes

The **SGE-25**, **SGE-16**, **SGE-25C** and **SGE-25S** are factory set to the range stated in the order. The user does not have access to the “zero” and “range” potentiometers. Setting may be adjusted by the manufacturer only.

### 9.2. Settings of SGE-25.SMART, SGE-25S.SMART probes

In **SGE-25.SMART** and **SGE-25S.SMART** probes with smart electronic, user can make e.g. set „zero” and measurement ranges.

### 9.3. SGE-25.SMART, SGE-25S.SMART. Measurement ranges. Definitions.

**9.3.1.** The maximum range of level, while the probe can measure is called „**basic range**” (for specifications of “basic range” see 5.1.1.).

The width of the basic range is the difference between the upper and lower limits of the basic range.

The internal characteristic conversion curve for the basic range is coded in the probe’s memory.

This is the reference curve used when making any adjustments which affect the probe’s output signal.

**9.3.2.** When the probe is in use the term “set range” is used.

The set range is the range whose lower end-point corresponds to an output current of 4mA and whose upper end-point corresponds to a current of 20mA (or 20mA and 4mA respectively when the conversion curve inverted). The set range may cover the whole of the basic range or only a part of it. The width of the set range is the difference between the upper and lower limits of the set range. The probe may be set to any range within the basic range of level values, subject the restrictions set out in the table in 5.1.1.

### 9.4. Configuration and Calibration.

**9.4.1.** The **SGE-25.SMART** and **SGE-25S.SMART** probes has features which enable metrological and identification parameters to be set and altered. The configurable metrological parameters affecting the probe’s output signal include the following:

- a) unit in which the measured level is expressed on the display
- b) upper end-point of the set range
- c) lower end-point of the set range
- d) time instant
- e) type of characteristic curve: linear or radical

Parameters of an informational nature which cannot be altered include the following:

- f) upper limit of the basic range
- g) lower limit of the basic range
- h) minimum set range

**9.4.2.** Other identification parameters, not effecting the output signal, include: device address, device code, factory identification code, factory device code, number of preambles (3÷20), UCS, TSD, program version, electronics version, flags, factory number, label tag, description tag, date tag, message, record number, sensing module number.

The process of setting the parameters listed in 9.4.1 and 9.4.2 is called “Configuration”.

**9.4.3.** It is possible to adjust the probe’s **zero point**, for example to compensate for deviation resulting from a change in position of installation.

The probes may also be **calibrated**, by taking readings with the input pressure controlled using a standard device. This process and zero-point adjustment are called “Calibration”.

**9.4.4.** Configuration and Calibration of the probe are carried out using an Aplisens KAP-03 or KAP-03Ex communicator, certain Hart communicators or a PC with Hart/RS232 converter and Aplisens Raport-2 software.

A description of the functions or the KAP... communicator is contained in KAP... Communicator Operating Manual, and information on the Hart/RS232 converter can be found on the Hart/RS232/01 Converter information sheet.



A list of Hart protocol commands implemented for SGE-25.SMART, SGE-25S.SMART probes is contained in the IO.HART operating instructions available at [www.aplisens.pl](http://www.aplisens.pl)



**After configuration it is important to protect the transducers using command HART [247]. During work transmitter should be safe prior to entries. This prevents accidental or intentional changes configurational data. The protection function is accessible in KAP03 communicator, “Raport’s-2” software, as well as, in applying DD or DMT programs libraries.**

## 10. INSPECTIONS, REPAIRS AND SPARE PARTS

### 10.1. Regular inspections.

**10.1.1.** Regular inspections should be carried out in accordance with the regulations to which the user subject. An inspection should be made of the external condition of the probe, during which:

- Check that there are no signs of mechanical damage in the form of impact marks or dents;
- Check the condition of the cable, which should not show signs of wearing, bending or fraying of the external coating; check the condition of the packing gland.

Every two years or in accordance with regulations applicable to the user, check the zero point (4mA).

**10.1.2.** Check the „zero point“ (**SGE-25, SGE-25S, SGE-25C**) bring the probe up above the surface of the liquid and read the output current. In case of excessive deviation of the zero reading, return the probe to the manufacturer for adjustment of the conversion curve or adjust the zero point of a device used in conjunction with the probe (e.g. monitor, regulator, controller).

**10.1.3.** Check the „zero point“ **SGE-25.SMART, SGE-25S.SMART** see 10.1.2.

### 10.2. Additional Inspections.

If the probe is installed in a place where it might have been subject to mechanical damage, wearing cable covering, excess pressure, hydraulic impulses, sedimentation, crystallization or erosion of the diaphragm, or excess electrical voltage, inspections should be made as necessary.

Check the state of the diaphragm and cable, clean the diaphragm, check the zero point.

#### **10.2.1. Faults in the Transmission Line.**

If there is no current in the line or the value of the current is random, check the transmission line, the connections with the terminal adapters, connectors etc.

If the transmission line is in good order, check whether the probe is functioning correctly.

#### **10.2.2. Protection from Excess Voltage.**

The probe may be in danger from excess voltage caused by connection faults or atmospheric electrical discharge.

Protection from excess voltage between the wires of the transmission line is provided by TVS diodes installed in all types of probe (see the table, column 2).

In order to protect against excess voltage between the transmission line and the casing or earth (not prevented by the diodes connected between the transmission wires), additional protection is provided in the form of plasma surge arresters (see the table, column 3).

Also external protective devices may be used, e.g. the UZ-2 Aplisens system, or others.

Internal protection of transmitters:

1	2	3
Type of transmitter	Protection between wires (TVS diodes) – permitted voltage	Protection between wires and earth and/or casing – type of protection, permitted voltage
SG-25.SMART series	68V DC	Plasma surge arresters - 230V DC (Performance of normal and Exi SA)

The voltage in the protective elements must not exceed the maximum permitted values given in columns 2 and 3 of the table.



The insulation test voltages (500V AC or 750V DC) given in 5.1.1 for probe without plasma surge arresters.

In case of a large surge of excess voltage between the wires of the line, the safety diode may sustain damage due to a low-resistance short circuit (a diode damaged in this way still provides protection to the probe's circuits).

Symptoms of damage:

- when the probe is connected to the power supply, the value of the current exceeds 20 mA, and the voltage on the probe is of an order of several hundred mV (in extreme cases a particularly strong surge may cause circuits or wires inside the probe to burn out; the current is then 0 mA and there is full voltage in the output circuit).

- when the probe is not connected to a power supply, the resistance of the probe should be measured; this is approximately 10Ω and is equal to the value of the limiting resistors + resistance of the damaged diode.

Damage to the gas-filled spark gap (Plasma surge arresters) is much less likely than damage to the diode, and may lead to a short circuit or a lowering of the resistance of the spark gap.

### 10.2.3. Damage Caused by Overpressure

Another possible reason for malfunctioning of the probe is damage caused by overpressure, which may result from such factors as

- a) Freezing of the medium,
- b) Dynamic effects of a strong current of liquid on the diaphragm seal while the probe is being washed (applies mainly to the **SGE-25S**, **SGE-25S.SMART** model);
- c) Striking or scraping of the diaphragm with a hard object, such as a screwdriver;

If excess pressure on the probe has caused damage to the silicon or sealing diaphragm, the probe can no longer be used. Symptoms of such damage are generally such that the output current falls below 4 mA or rises above 20 mA, and the probe fails to react to input pressure.

### 10.2.4. Cleaning the Diaphragm Seal

Impurities which have accumulated on the diaphragm during operation should not be removed by mechanical means such as scraping, scrubbing etc., as this may cause damage. The only permitted method is to dissolve the impurities, possibly aiding their removal with a light brush.

Sedimentation on the diaphragm may affect the conversion curve.

Examples of ways of cleaning the diaphragms:

- a. In the case of boiler scale on and around the diaphragm, the lower part of the probe including the diaphragm should be immersed for approximately 20 minutes, for example in a 10% solution of Kamix, which is available from the manufacturer.
- b. Deposits of petroleum-derived substances should be softened and rinsed off with a solvent of detergent
- c. Deposits of organic substances or food products (juice, syrup etc.) should be softened in warm water up to 85° C, or in detergent in the case of fats.

**i** After removing sedimentation, parts which have come into contact with the solvent substance should be thoroughly rinsed, and the health and safety regulations relating to the chemical in question should be adhered to.

**Do not use substances which might cause corrosion of the diaphragm seal.**

## 10.3. Spare Parts.

The following parts of the probe can be replaced when worn or damaged: cable, seals on the packing gland. The cable may be replaced by the manufacturer only.

## 11. PACKING, STORAGE AND TRANSPORT

### 11.1. Packing, Transport.

The probes should be packed in such a way as to protect them from damage during transportation, in single or multiple packs. The cable should be rolled into a loop  $\geq 300$  mm in diameter, secured so as to prevent the coils from moving relative to each other and the whole from moving within the package. Avoid breakage to the cable at the point where it enters the packing gland. Packing should take place in closed rooms, where the air temperature is not lower than +15°C, relative humidity does not exceed 85%.

Land, sea or air transport may be used, provided that direct action of atmospheric effects is prevented.

### 11.2. Storage

The probes should be stored in multiple packs in covered rooms, free of vapours and reactive substances, with an air temperature between +5°C and +40°C and relative humidity not greater than 85%.

## 12. GUARANTEE.

The manufacturer guarantees the proper functioning of the probes **SGE-25.SMART**, **SGE-25S.SMART**, **SGE-25**, **SGE-16**, **SGE-25C** for a period of 24 months starting from the date of purchase (probe **SGE-25S** for a period of 12 months), as well as servicing carried out under the guarantee and following the guarantee period.

## 13. ADDITIONAL INFORMATION

Related standards:

PN-EN 60529:2003

PN-EN61010-1

Ingress protection rating of casing (IP code)

Safety requirements for automated electrical measuring devices and laboratory devices. General requirements.



14. FIGURES

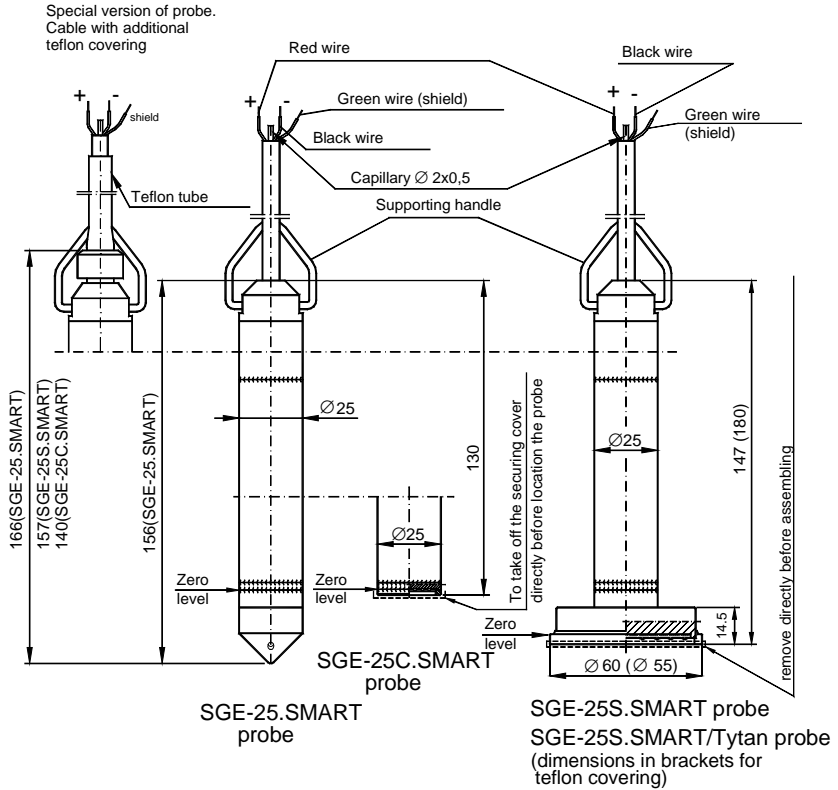

Figure 1 SGE-25.SMART and SGE-25S.SMART probes – dimensions

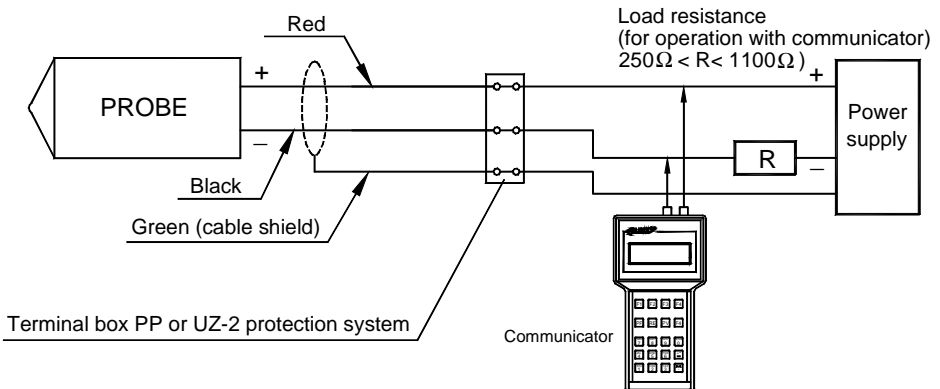

Figure 2. SGE-25.SMART and SGE-25S.SMART probes – connection method

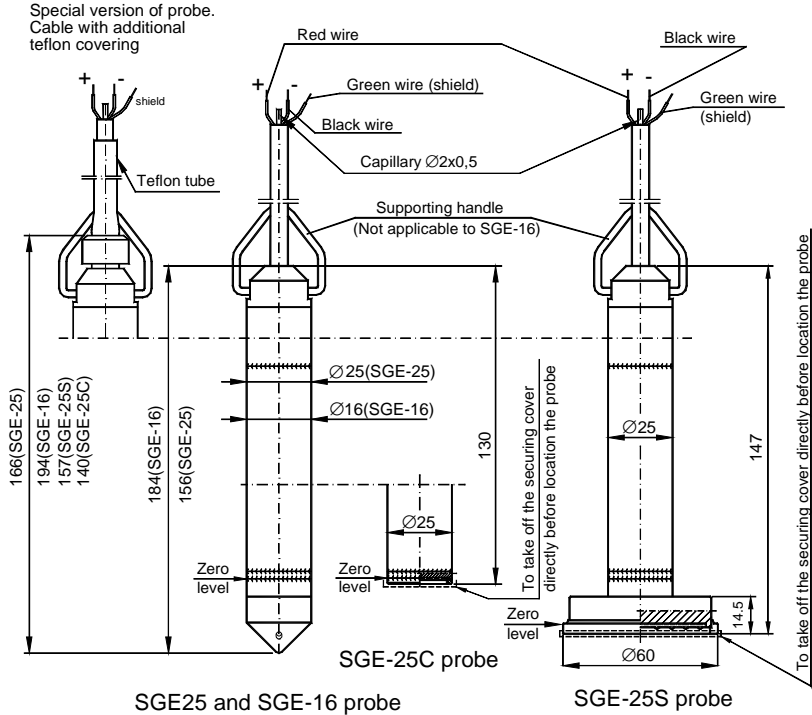

Figure 3. SGE-25, SGE-16,SGE-25C and SGE-25S probes – dimensions

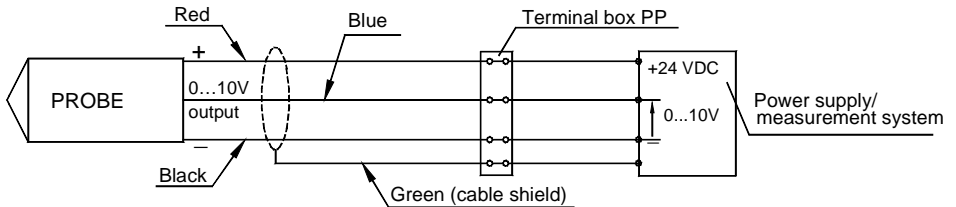

Figure 3A. Connection of SGE-25, SGE-25S and SGE-25C in a three-wire system (0...10V output signal).  
Not applicable to Ex version.

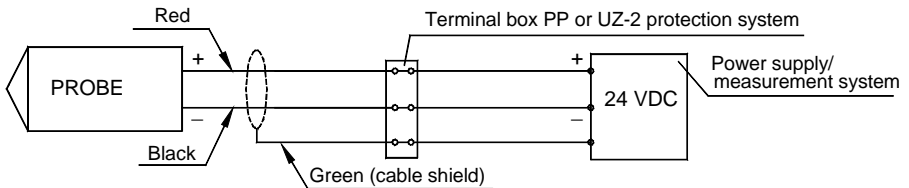

Figure 3B. Connection of SGE-25, SGE-16, SGE-25S and SG-25C in a two-wire system  
(4...20mA output signal).  
Not applicable to Ex version.

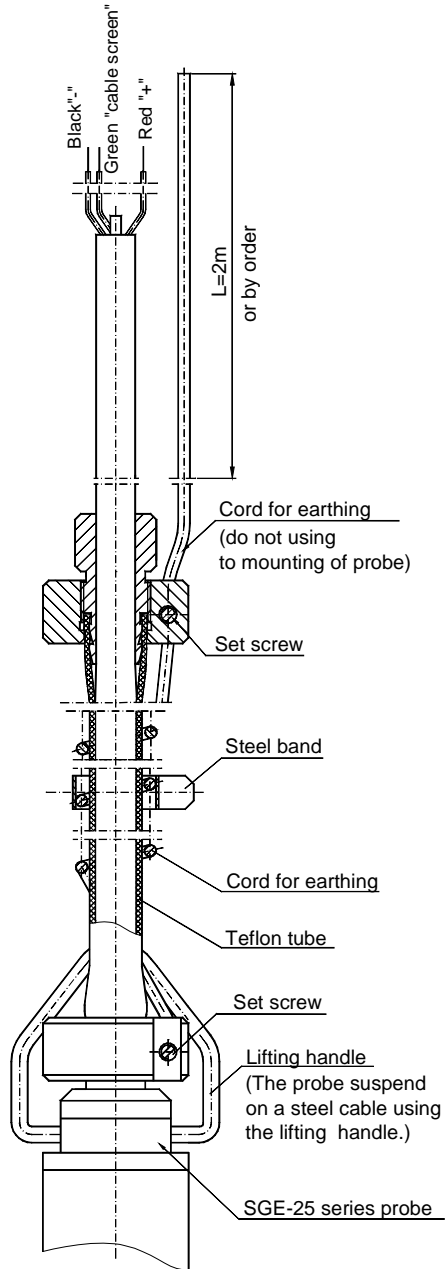

Figure 4. The probe in Ex-version with a cable with Teflon shield.

