

Vortex Flowmeter

User's Manual



Content

I. Summary.....	2
II . Working Principle.....	2
III. Basic Parameter.....	3
3.1 Flow Range.....	3
IV. Wiring.....	6
4.1 Terminal Board Wiring.....	6
V. LCD Display.....	8
VI. Production Process Using HART-Config Tool.....	9
VII. Data Entry.....	10
7.1 Basic Function of Keys.....	10
7.2 Enter or Exit Menu Mode.....	11
7.3 Data Entry Method.....	11
7.4 Local Configuration Function.....	13
7.5 Totalizer Flow Unit Table.....	17
VIII. Parameter Description.....	17
8.1 K- Factor.....	17
8.2 Five-point Linearity Correction.....	17
8.3 Pulse Factor Description.....	17
8.4 Output Original Pulses Description.....	18
8.5 Temperature and Pressure Compensation.....	18
IX. Vortex Flow Meter Installation Condition.....	19
9.1 Flange or wafer vortex flow meter installation notice.....	19
9.2 Installing a insertion vortex flowmeter.....	21

I. Summary

Vortex Flowmeter is one kind of main flowmeters in the international for detection and metering the liquid, gas and steam. It is widely used in Petroleum, chemical, metallurgy, heat supply industry, etc.

Features:

- Detecting element does not touch with flow medium, with high reliability yand strong flexibility for medium
- No moving parts, wear resistance, structure is simple and fastness
- Good earthquake resistance
- The allowed working temperature is wide from -40°C to +350°C
- Wide range, High accuracy
- Pulse signal output or two-wire system 4-20mA current signal output

II. Working Principle

Setting a triangular prism vortex generator in the flowmeter, regular vortex will be generated at both the sides of triangular prism, which is called Karman swirl. As showed on the drawing 1.1, vortex are arranged regularly at the downstream of vortex generator. Suppose the vortex generation frequency is F , the average flow velocity of medium is V , d is the width of the surface of triangular prism incident flow, and D for the nominal diameter of flowmeter. Then we get the computation formula:

$$f = Sr \frac{\bar{V}}{(1 \sim 1.25d/D) d}$$

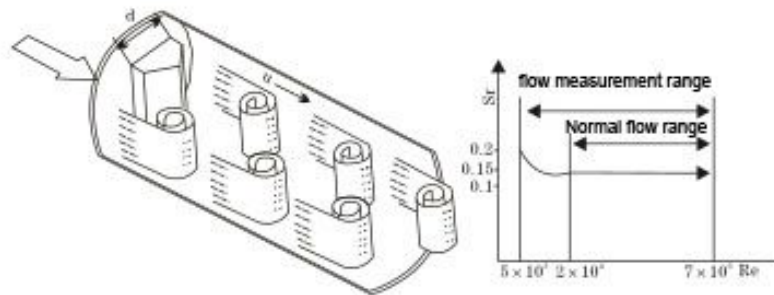

PIC 1: The working principle of Vortex flowmeter

III. Basic Parameter

Measured Medium	Liquid, Gas, Steam	
Medium Temp.	-40~+200°C; -40~+280°C; 40~+350°C	
Nominal Pressure	1.6MPa; 2.5MPa; 4.0MPa; 64MPa(Other pressure can be custom)	
Accuracy	±1.0%,±1.5%	
Measuring range ratio	1:8-1:30(Standard air condition as reference), 1:8-1:40(Normal Temperature as reference)	
Flow range	Liquid:0.4-7.0m/s; Gas:4.0-60.0m/s; Steam:5.0-70.0m/s	
Specifications	DN15~DN600	
Material	1Cr18Ni9Ti	
Reynolds number	Normal $2 \times 10^4 - 7 \times 10^6$	
Resistance coefficient	$Cd \leq 2.6$	
Vibration acceleration allowed	$\leq 0.2g$	
Ex-proof class	IP65 ExiaIICT6 Ga	
Ambient condition	Ambient Temp.	-40°C-65°C(Non Display on site); -20°C-55°C(Display on site)
	Relative humidity	$\leq 5\% \sim 93\%$
	Pressure	86-106kPa
Power Supply	12-24V/DC or 3.6V battery powered	
Signal Output	Pulse frequency signal 2-3000Hz, Low level $\leq 1V$, high level $\geq 6V$	
	Two-wire system 4-20 signal(isolated output), Load ≤ 500	

3.1 Flow Range

Full tube vortex flowmeter measuring range (Check table 1, table 2, table 3, table 4)

Table 1: Vortex flowmeter for gas:

Diame ter	Meter factor/m ³	Normal Gas and Steam			
		Measuring	Frequency	CH Selection	Amplificati

mm		range m ³ /h	Setting Hz		on factor
15	350000	3-50	300~3900	CH3	500
20	145000	5-80	200~3000	CH3	500
25	80000	6-120	150~2500	CH3	500
32	35000	10-150	100~2200	CH3	500
40	19000	16-320	80~2000	CH3	500
50	9100	25-500	50~1200	CH3	500
65	4260	40-800	40~900	CH3	500
80	2300	60-1250	30~800	CH3	500
100	1200	100-2000	25~600	CH3	500
125	580	150-3000	20~500	CH3	500
150	345	200-4500	15~400	CH3	500
200	145	300-8000	10~320	CH3	500
250	73	500-12000	8~240	CH3	500
300	43	800-18000	7~200	CH3	500
350	27	1000-24000	6~180	CH3	500
400	18	1500-30000	5~150	CH3	500
450	13	2000-40000	4~130	CH3	500
500	9	2500-50000	4~120	CH3	500
600	5	3000-70000	3~100	CH3	500

Table 2: The flow range of vortex flowmeter for liquid.

Size mm	Meter factor/m ³	Liquid(Water)			
		Measuring range m ³ /h	Frequency Setting Hz	CH Selection	Amplification factor
15	350000	0.8-9	40~800	CH2	500
20	145000	1.2-15	30~600	CH2	500
25	80000	2-18	18~360	CH2	500
32	35000	2.5-30	15~300	CH2	500
40	19000	3 -48	10~250	CH2	500
50	9100	5-75	9~190	CH2	500
65	4260	8-120	8~160	CH2	500
80	2300	14-180	51~20	CH2	500
100	1200	22-300	4~100	CH2	500
125	580	40-450	3~90	CH2	500
150	345	56-660	2~60	CH2	500
200	145	100-1200	2~50	CH2	500
250	73	150-1800	2~40	CH2	500
300	43	200-2500	2~35	CH2	500
350	27	280-3500	1~30	CH2	500
400	18	380-4500	1~25	CH2	500
450	13	480-6000	1~20	CH2	500
500	9	600-7000	1~18	CH2	500

600	5	800-10000	1~15	CH2	500
-----	---	-----------	------	-----	-----

Table 3: The flow range of vortex flowmeter for saturated steam.

Abs Pre.P(Mpa)	0.2	0.3	0.4	0.5	0.6	0.7	0.8	0.9	1.0	1.2	1.4	1.6	1.8	2.0
Temp.T(°C)	120.2	133.5	143.62	151.84	158.94	158.94	170.41	175.36	179.68	187.96	195.04	201.37	207.11	212.37
Density kg/m³	1.129	1.651	2.163	2.669	3.170	2.669	4.162	4.665	5.147	6.127	7.106	8.085	9.065	10.05
DN20 Qmin	9	11	12	13	15	16	17	18	19	20	22	24	25	26
QMax	60	83	108	134	158	183	208	233	257	306	355	404	453	503
Measurable Up Limit	80	102	130	160	190	220	250	279	309	368	426	485	544	603
Measurable Low Limit	9	11	12	13	15	16	17	18	19	20	22	24	25	26
DN25 Qmin	14	17	19	21	23	25	27	28	30	33	35	37	39	42
QMax	93	133	173	215	254	293	333	372	412	490	568	647	725	804
Measurable Up Limit	136	198	260	320	380	440	499	559	618	735	853	970	1088	1206
Measurable Low Limit	14	17	19	21	23	25	27	28	30	33	35	37	39	42
DN40 Qmin	35	42	48	54	59	63	67	71	75	82	88	94	99	104
QMax	233	332	433	534	634	733	832	931	1029	1225	1421	1617	1813	2010
Measurable Up Limit	400	498	649	801	951	1100	1249	1397	1544	1838	2132	2426	2720	3015
Measurable Low Limit	32	38	44	48	53	57	60	64	67	73	79	84	89	94
DN50 Qmin	52	64	73	81	88	95	100	107	112	122	132	140	149	157
QMax	400	498	649	801	951	1100	1249	1397	1544	1838	2132	2426	2720	3015
Measurable Up Limit	667	826	1080	1335	1585	1834	2081	2328	2574	3054	3553	4043	4533	5025
Measurable Low Limit	52	64	73	81	88	95	100	107	112	122	132	140	149	157
DN65 Qmin	88	106	121	135	147	158	168	178	187	204	220	234	248	261
QMax	667	826	1080	1335	1585	1834	2081	2328	2574	3054	3553	4043	4533	5025
Measurable Up Limit	933	1320	1730	2135	2536	2934	3330	3724	4118	4902	5685	6468	7252	8040
Measurable Low Limit	88	106	121	135	147	158	168	178	187	204	220	234	248	261
DN80 Qmin	140	170	194	215	235	252	269	284	299	326	350	375	397	418
QMax	1166	1650	2160	2700	3170	3660	4160	4655	5150	6130	7100	8080	9060	10000
Measurable Up Limit	1400	1980	2596	3240	4015	4644	5270	5896	6520	7760	9000	10240	11480	12730
Measurable Low Limit	105	127	145	161	176	189	201	213	224	345	263	280	298	313
DN100 Qmin	175	212	242	269	293	315	336	355	374	408	439	468	496	522
QMax	1166	1650	2160	2700	3170	3660	4160	4655	5150	6130	7100	8080	9060	10050
Measurable Up Limit	2332	3300	4320	5400	6430	7320	8320	9310	10300	12260	14200	16160	19120	20100
Measurable Low Limit	175	212	242	269	293	315	336	355	374	408	439	468	496	522
DN125 Qmin	262	317	363	404	440	473	504	533	560	611	658	702	744	783
QMax	1866	2640	3460	4270	5070	5870	6660	7450	8240	9800	11370	12940	14500	16080
Measurable Up Limit	3500	4950	6490	8000	9510	11000	12500	14000	15440	18400	21300	24260	27200	30200
Measurable Low Limit	262	317	363	404	440	473	504	533	560	611	658	702	744	783
DN150 Qmin	437	529	605	673	733	788	840	888	934	1091	1097	1171	1239	1305
QMax	292	4130	5408	6670	7930	9170	10400	11640	12870	15320	17770	20210	22600	25120
Measurable Up Limit	4666	6600	8650	10680	1268	14670	16650	18620	20590	24500	28420	32340	36260	40200
Measurable Low Limit	350	423	484	538	586	631	672	711	747	815	878	936	990	1044
DN200 Qmin	700	847	969	1076	1173	1261	1344	1421	1494	1630	1756	1873	1983	2088
QMax	4666	6600	8650	10680	12680	14670	16650	18620	20590	24500	28420	32240	36260	40200
Measurable Up Limit	9330	13200	17300	21360	25360	29340	33300	37240	41180	47000	56850	64680	72520	80400
Measurable Low Limit	610	740	848	942	1026	1104	1176	1243	1308	1427	1536	1638	1735	1827
DN250 Qmin	1050	1270	1614	1759	1892	2016	2132	2241	2336	2634	2808	3013	3219	3426
QMax	6998	9906	12980	16010	19020	22000	24970	27930	30880	36760	42640	48500	54390	60300
Measurable Up Limit	13997	19810	25960	32030	38040	44000	49940	55860	61760	73520	85270	97000	108780	120600
Measurable Low Limit	875	1056	1210	1345	1466	1577	1680	1776	1868	2038	2195	2340	2480	2610
DN300 Qmin	1750	2116	2422	2690	2932	3153	3359	3550	3736	4076	4389	4682	4958	5220
QMax	11664	16510	21630	26690	31700	36670	41620	46550	51470	61270	71010	80850	90650	10050
Measurable Up Limit	20995	29720	38930	48040	57050	66000	74900	83800	92650	110300	127900	145530	16320	180900
Measurable Low Limit	1050	1270	1453	1614	1759	1892	2016	2132	2241	2446	2634	2808	2975	3132

Table 4: Density and Relative Pressure and Temperature of superheated steam(Kg/m³)

Absolute pressure MPa	Temperature (°C)					
	150	200	250	300	350	400
0.1	0.52	0.46	0.42	0.38		
0..15	0.78	0.70	0.62	0.57	0.52	0.49
0.2	1.04	0.93	0.83	0.76	0.69	0.65
0..25	1.31	1.16	1.04	0.95	0.87	0.81
0.33	1.58	1.39	1.25	1.14	1.05	0.97
0.35	1.85	1.63	1.46	1.33	1.22	1.13
0.4	2.12	1.87	1.68	1.52	1.40	1.29
0.5		2.35	2.11	1.91	1.75	1.62
0.6		2.84	2.54	2.30	2.11	1.95
0.7		3.33	2.97	2.69	2.46	2.27
0.8		3.83	3.41	3.08	2.82	2.60
1..0		4.86	4.30	3.88	3.54	3.26
1.2		5.91	5.20	4.67	4.26	3.92
1.5		7.55	6.58	5.89	5.36	4.93
2.0			8.968	7.97	7.21	6.62
2.5			11.5	10.1	9.11	8.33
3.0			14.2	12.3	11.1	10.1
3.5			17.0	14.6	13.0	11.8
4.0				17.0	15.1	13.6

IV. Wiring

4.1 Terminal Board Wiring

The terminal board is used for connects the external power supply, output pulse, the external pressure sensor and temperature sensor.

The following are common wiring.

4.1.1 24VDC Power supply+4-20mA+HART+External Pressure and Temperature sensors

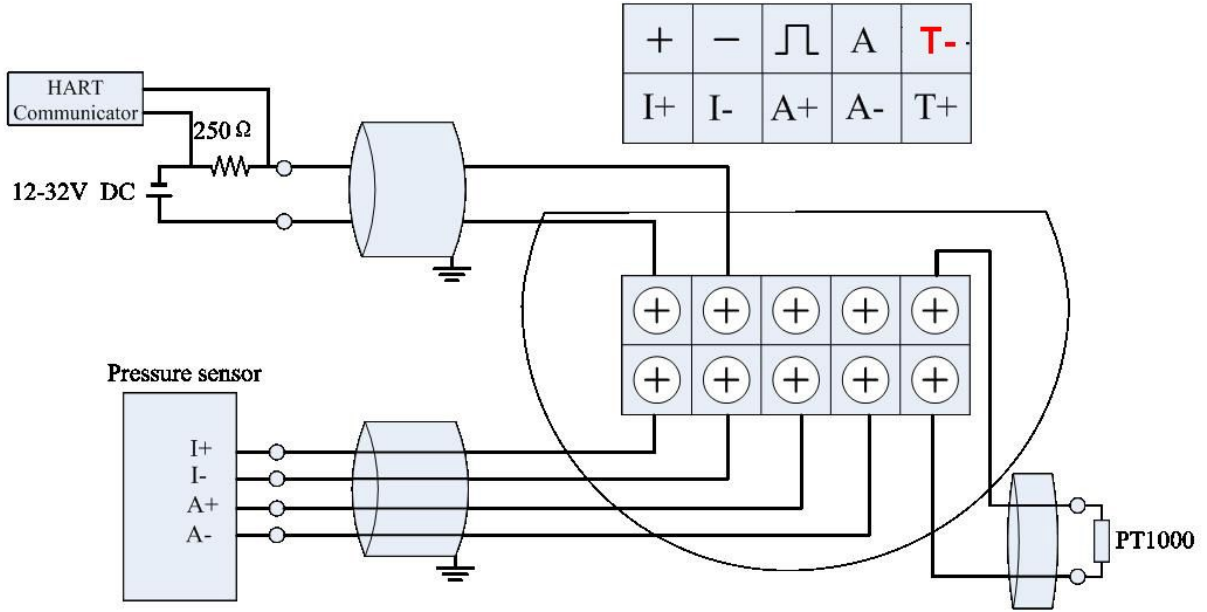

4.1.2 24VDC+RS485+Pulse Output+External Pressure and Temperature sensors

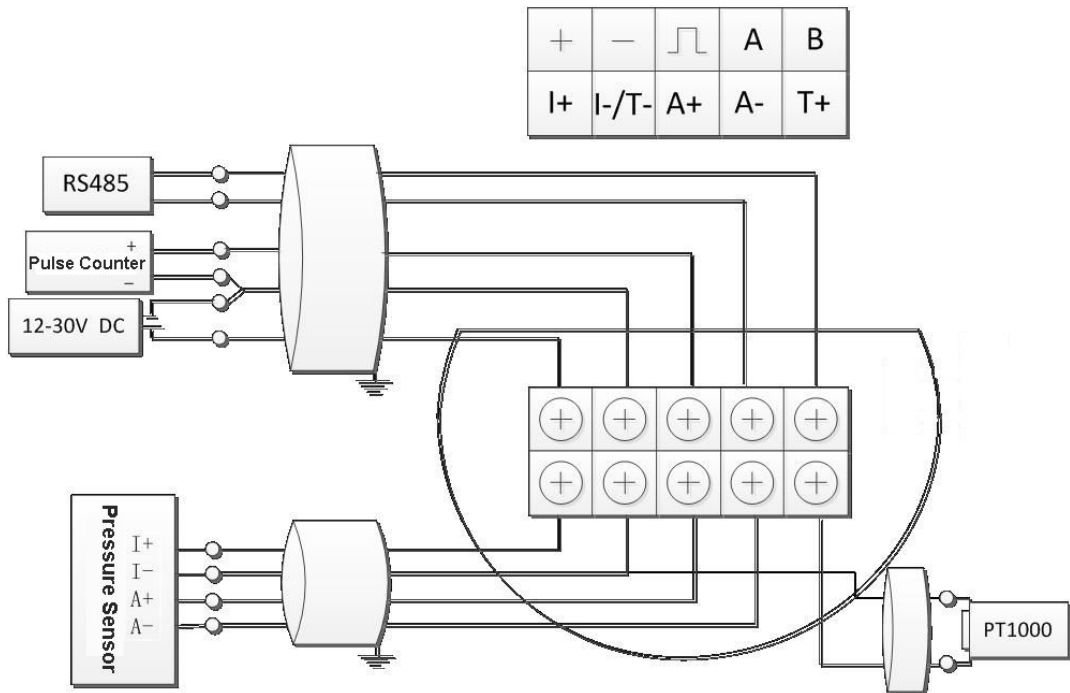

4.1.3 24VDC+4~20mA output+ HART

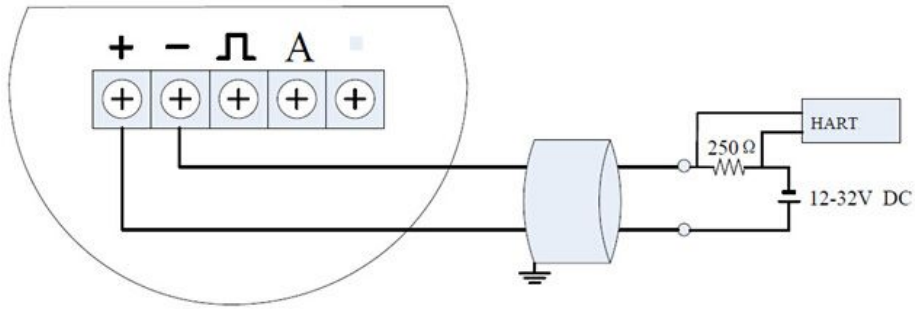

4.1.4 24VDC+Pulse Output+ RS485

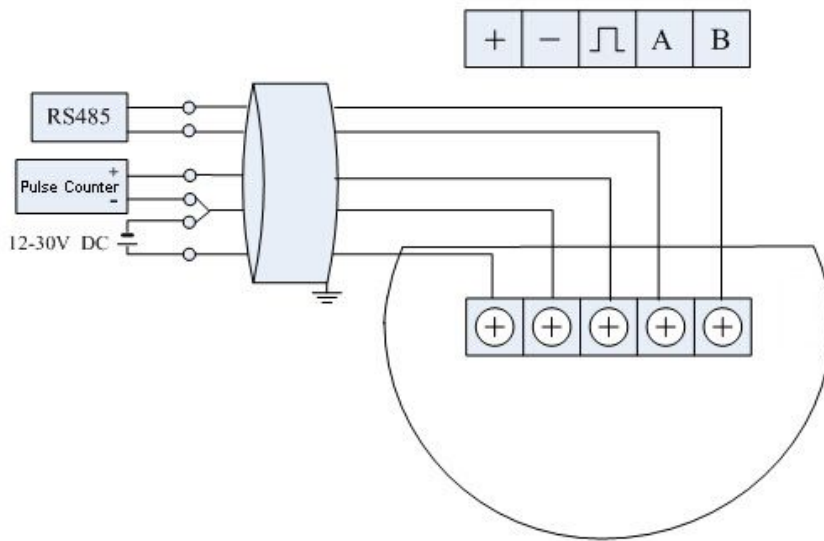

V. LCD Display

LCD Full display is as Figure 3-1:

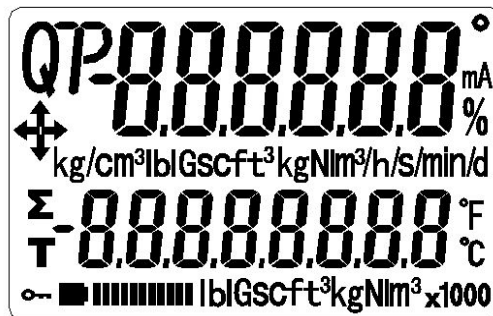

Figure 3-1 LCD Screen

Two-line LCD display. Instant flow rate and totalized flow value can be displayed simultaneously with high-brightness backlight, as Figure 3-2.



Figure 3-2 Instant flow rate and totalized flow value

Short press M to set the second line display which are the frequency, pressure, temperature, density, current, or percentages.

The following table describes the Prompt and variables.

Prompt	Σ	F	d	P	T	I	%
variable	totalized flow	frequency	density	pressure	temperature	current	percentage

Notes:

- In write protection mode, display .
- Measured value is lower than the lower limit alarm value, flashing the "down arrow".
- Measured value is higher than the upper limit alarm value, flashing the "up arrow".
- If enable automatic measure pressure, and the pressure signal abnormality (sensor fault), flashing the "left arrow".
- If enable automatic measure temperature, and the temperature signal abnormality (sensor fault), flashing the "right arrow".

VI. Production Process Using HART-Config Tool

Connect the flow meter as shown in Figure 4-1.

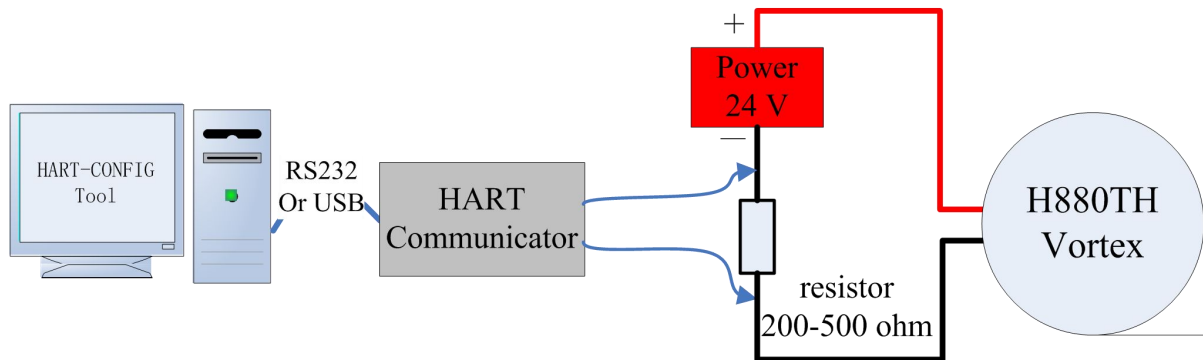
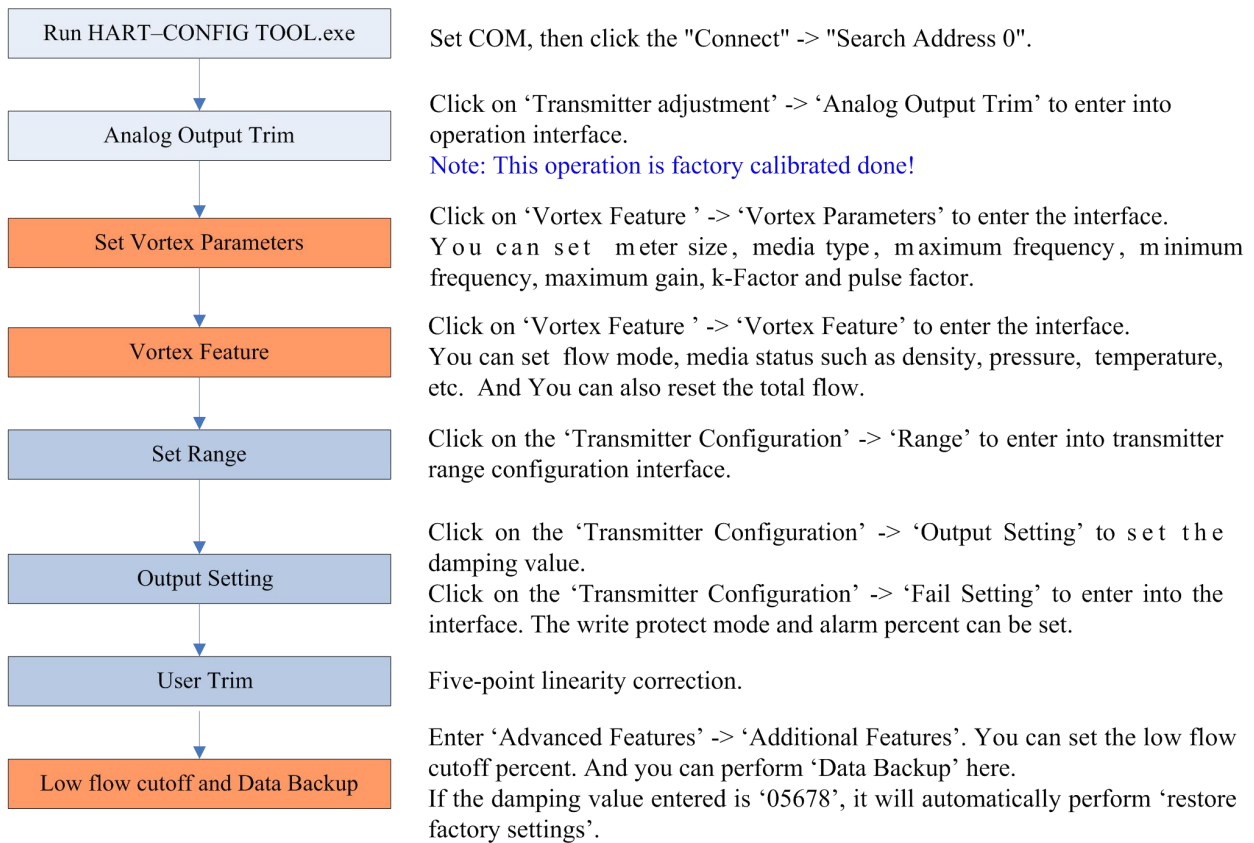

Figure 4-1 HART communication connection diagram

Run HART-CONFIG TOOL, follow these steps to complete the production process of vortex flowmeters.



Note: This color means that these items must be done. This color means that these items must be done, and easily forgotten or incorrectly set.

VII. Data Entry

7.1 Basic Function of Keys

Data is entered using the 3 keys M, S and Z on the display.

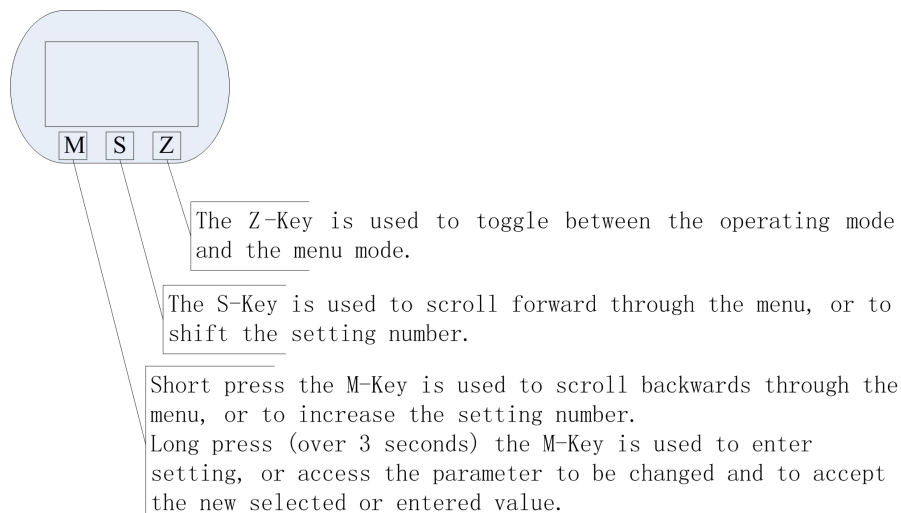

7.2 Enter or Exit Menu Mode

7.2.1 Enter Menu Mode

In the operating mode, press the "Z" key to enter the menu mode (data entry).

7.2.2 Exit Menu Mode

In the menu mode, press the "Z" key to enter the operating mode.

7.3 Data Entry Method

There are two ways to set parameters, one is numeric, and the other is from table .

7.3.1 'Numeric' Method

- Long press the M-Key to enter setting, and the sign flag will start flashing.
- Short press the M-Key to select the sign.
- Press the S-Key to shift the setting number. The number bit will start flashing, which means that you can set. Press M-Key to increase the setting number.
- Press the S-Key to shift the setting number again. All bits can be set according to the same operation.
- After setting all 6-bits, press S-Key to set decimal point position. And five decimal points will flash simultaneously, which means that you can set. Short press M-Key to change the decimal point position.
- After completion of data entry, you can long press M-Key to save (access) the parameter. Or Press Z-Key to give up.

For example, the original range limit is 200, the new input range limit is 400.

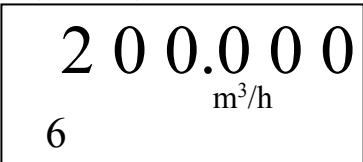
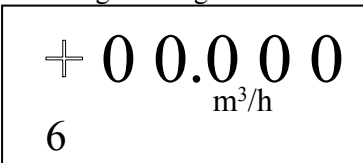
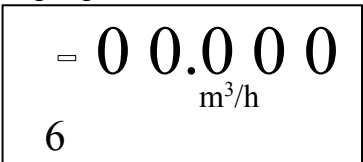
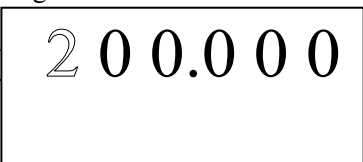
<ul style="list-style-type: none"> ➤ Press the Z-key to enter the menu mode. ➤ Press M-Key or S-Key to scroll backwards or forwards the menu until display 6 in the bottom-left. Then you can set the range limit. 	<p>Setting the range limit</p> 
<ul style="list-style-type: none"> ➤ Long press M-Key to enter setting, and the sign flag will start flashing. 	<p>Enter setting the range limit</p> 
<ul style="list-style-type: none"> ➤ Short press the M-Key to select the sign between "+" and "-". "-" means input is negative (less than 0, vortex flowmeter range limit must be a positive number). 	<p>Setting negative data</p> 
<ul style="list-style-type: none"> ➤ Press the S-Key, the first bit "2" will start flashing, which means you can change this bit. 	<p>Setting first bit</p> 

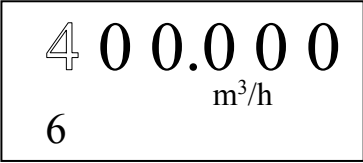
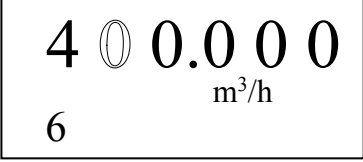
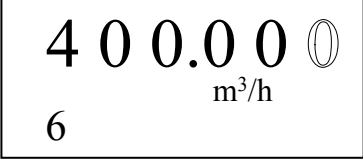
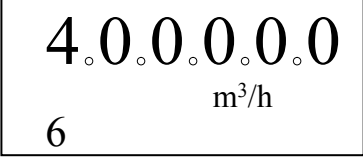
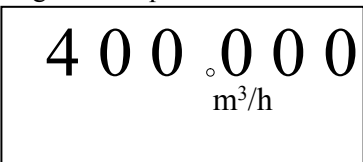
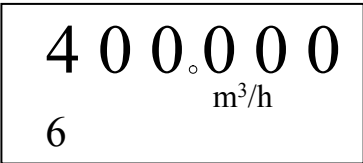
	m ³ /h 6
➤ Press the M-Key until display “4”.	Setting first bit 
➤ Press S-Key, the second bit “0” will start flashing, which means you can change this bit. ➤ Press M-Key to set new data.	Setting the second bit 
➤ Press the S-Key to shift the setting number again. All bits can be set according to the same operation.	Setting the last bit 
➤ After setting all 6-bits, press S-Key to set decimal point position. And five decimal points will start flashing simultaneously, which means that you can set.	Setting decimal point 
➤ Short press M-Key to change the decimal point position.	Setting decimal point  
➤ After completion of data entry, you can long press M-Key to save (access) the parameter. Or Press Z-Key to give up.	

7.3.2 From Table Method

- Long press M-Key to enter setting, and the menu options will start flashing.
- Short press M-Key or S-Key to scroll backwards or forwards the menu.

- Long press M-Key to save (access) the parameter.



7.4 Local Configuration Function

The character “88” on the bottom-left of LCD corresponding menu item:

character	Menu	Setting method	Notes
01	Write Protect	from table	ON / OFF
02	Low Alarm Limit	numeric	Unit: %
03	High Alarm Limit	numeric	Unit: %
04	Flow mode	from table	LIq_0: Liquid volume LIq_1: Liquid mass GAS_0: Gas volume GAS_1: Gas mass ST_0: Steam volume ST_1: Steam mass ST_2 : Saturated steam mass (temperature compensation) ST_3 : Saturated steam mass (pressure compensation)
05	Flow unit	from table	Nm ³ /h, Nm ³ /m, Nm ³ /s, m ³ /d, m ³ /h, m ³ /m, m ³ /s, l/h, l/m, l/s, t/d, t/h, t/m, kg/d, kg/h, kg/m, kg/s, g/h, g/m, g/s, Note: Totalizer flow's unit based on the flow unit.
06	Range (Qmax)	numeric	Qmax value for selected flow mode (= 20 mA)
07	Density	numeric	Gas density (unit: Kg/m ³) Liquid density (unit: g/cm ³)
08	Gas pressure (Gauge)	numeric	Unit: kpa.
09	Gas temperature (Degrees C)	numeric	Unit: °C.
10	Low flow cutoff value	numeric	Range: 0% ~ 20%
11	Damping	numeric	Range: 0 ~ 64S
14	Total reset	from table	When Lcd display ACC_y, press M-Key to reset the total and overflow counter.
15	Number of total overflows	read only	Display of the number of total overflows; max. 99,999 1 overflow = 10,000,000
40	Trim 4mA		Steps: 1. Long press M-Key, enter trim; 2. Short press M-key to decrease current. Press S-Key to increase current. Stepping is 12 microamperes.
41	Trim 20mA		

			3. Long press M-Key to save new trim value. Or press Z-Key to exit without saving.
50	Opcode	numeric	Input ****50, set 51~ 57 menu. Input ****40, set 40~ 41 menu. Input ****60, set 60 menu. Input ****62, set 62 menu. Input ****63, set 63 menu. Input ****70, set 70~77 menu.
51	Signal status	read only	LCD display: 450.00 51 2 - 10 status: 450.00 is the gain, 51 is indicator, 2 is channel, 10 is signal amplitude, it must be greater than 9.
52	Meter size and media type	from table	Options: 15mm, 20mm, 25mm, 32mm, 40mm, 50mm, 65mm, 80mm, 100mm, 125mm, 150mm, 200mm, 250mm, 300mm, 350mm, 400mm, 450mm, 500mm, 600mm; Note: Maximum frequency, minimum frequency, maximum gain and average calibration K- Factor should be reset , if meter size or media type changed. Media type is gas, setting interface: <div style="border: 1px solid black; padding: 10px; width: fit-content; margin: 10px auto;"> <p style="text-align: center;">52 G A S</p> </div> Media type is liquid, setting interface: <div style="border: 1px solid black; padding: 10px; width: fit-content; margin: 10px auto;"> <p style="text-align: center;">d - 2 5</p> <p style="text-align: center;">52 L I q</p> </div> If you change the meter size and media type, you must re-set from 53 to 56.
53	Maximum frequency	numeric	According to the meter size and measuring media, set the corresponding maximum frequency.
54	Minimum	numeric	According to the meter size and measuring

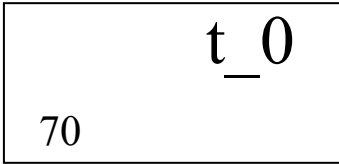
	frequency		media, set the corresponding minimum frequency.
55	Maximum gain	numeric	Between 200 and 1000 suggested. Typically about 500.
56	k-Factor	numeric	Set average calibration k-Factor
57	Pulse factor	numeric	Set the output pulse number corresponding 1m3.
60	Five-point linearity correction	numeric	<p>Where P is the reference frequency, Y is the correction coefficient K.</p> <p>When input frequency value, the lower right corner shows P_i, $i=1,2,3,4,5$. When $i = 1$, LCD show as follows:</p> <div style="border: 1px solid black; padding: 10px; text-align: center;"> <p>100.00 60 P1</p> </div> <p>When input coefficient value, the lower right corner shows Y_i, $i=1,2,3,4,5$. When $i = 1$, LCD show as follows:</p> <div style="border: 1px solid black; padding: 10px; text-align: center;"> <p>1.0000 60 Y1</p> </div>
62	Channel settings	from table	<p>There are CH_1, CH_2, CH_3 three options. CH_3 gain maximum CH_1 gain minimum</p> <p>Set CH_1 show as follows:</p> <div style="border: 1px solid black; padding: 10px; text-align: center;"> <p>CH_1 62</p> </div> <p>Note: CH1 generally used for liquid measurement, which corresponds to the configuration software, select X0 and X1. CH_3 generally used for gas measurement, which corresponds to the configuration software, select X1, X2 and X3.</p>
63	Work mode settings	from table	<p>There are F_1, F_2, F_3, F_4 four options.</p> <p>F_2 setting show as follows:</p> <div style="border: 1px solid black; padding: 10px; text-align: center;"> <p>F_2</p> </div>

			63 Note: Generally choose F_2.
70	Temperature acquisition mode setting	from table	There are t_0 and t_1 two options. t_0: Temperature uses the input reference value. See Section 9: gas temperature. t_1: Temperature is automatic acquisition, should be use external pt1000. t_0 setting show as follows: 
71	Pressure acquisition mode setting	from table	There are P_0 and P_1 two options. P_0: Pressure uses the input reference value. See Section 8: gas pressure. P_1: Pressure is automatic acquisition, should be use external silicon pressure sensor. P_0 setting show as follows: 
72	Temperature low trim	numeric	Enter the calibration resistor value , unit: ohm.
73	Temperature high trim	numeric	Enter the calibration resistor value , unit: ohm.
74	Pressure low trim	numeric	Enter the calibration reference pressure value, unit kpa
75	Pressure high trim	numeric	Enter the calibration reference pressure value, unit kpa
76	Low pressure cutoff value	numeric	If the measured pressure value is less than " Low pressure cutoff value", set to 0kpa. Unit kpa.
77	Pressure bias settings	numeric	Enter the current actual pressure value, to achieve bias. Unit kpa.
90	Modbus address	numeric	Range: 1~63
91	Baut Rate	From table	9600Hz, 4800Hz,2400Hz, 1200Hz, 600Hz.

Special Note:

Maximum frequency, minimum frequency, maximum gain and average calibration K- Factor should be

reset, if meter size or media type changed. These parameters are very important for vortex flowmeter good working, please carefully set according to the actual application.

7.5 Totalizer Flow Unit Table

Totalizer flow's unit is determined according to the flow unit.

Flow Unit	Totalizer Flow Unit
Nm ³ /h, Nm ³ /m, Nm ³ /s,	Nm ³
m ³ /d, m ³ /h, m ³ /m, m ³ /s	m ³
l/h, l/m, l/s	l
t/d, t/h, t/m	t
kg/d, kg/h, kg/m, kg/s	kg
g/h, g/m, g/s	g

VIII. Parameter Description

8.1 K- Factor

The average k-Factor value shown in the display must be the same as the value on the primary tag on the flowmeter primary.

8.2 Five-point Linearity Correction

The actual k-Factor of vortex flowmeter is different in low flowrates and high flowrates. In order to improve the accuracy of vortex flowmeter, it provides 2 to 5 points k-Factor correction.

For example, for D = 80mm, measuring medium is liquid, the real k-Factor in different flowrates as follows:

<20 Hz	40	80	> 100
2200	2100	2100	2000

Then we can choose 4-points calibrated, set k-Factor 2100. Enter the calibration data as follows:

Frequency	k-Factor coefficient	formula
20	0.954545	2100/2200=0.954545
40	1	2100/2100=1
80	1	2100/2100=1
100	1.05	2100/2000=1.05

8.3 Pulse Factor Description

There are two ways to set the pulse factor via HART-CONFIG Tool.

1. Set the number of pulses output every 1m³.
2. Set a pulse corresponds to how many m³.

The output pulses are based on the flow value after five-point K-Factor correction. That will get higher accuracy than using the original pulses.

The local adjustment menu 57 is used to set the output pulse number corresponding 1m³.

8.4 Output Original Pulses Description

If you need the flowmeter outputs original pulses, follow the following steps:

1. Set the K- Factor and the Pulse Factor equal. That is the value of local adjustment menu 56 and 57 equal.
2. Cancel the Five-point linearity correction via HART-CONFIG Tool. Or enter the local adjustment menu 60 to set all of correction coefficient K equal 1.0.

Then the flowmeter output pulse frequency equals to the original pulse frequency.

8.5 Temperature and Pressure Compensation

8.5.1 Precondition

The pressure sensor should be bridge type sensors and the temperature sensor should be PT1000.

User input reference pressure should be gauge pressure, and the unit must be kpa. Absolute pressure and gauge pressure relationship: Absolute pressure = gauge pressure + 101.325kPa.

User should input the reference resistor when trim the temperature sensor.

8.5.2 Pressure Sensor Trim

If you want trim the pressure sensor, please check the flow mode and pressure acquisition mode setting.

character	Menu	Setting
04	Flow mode	Set one of the following: (The other modes do not collect pressure) GAS_0: Gas volume: GAS_1: Gas mass: ST_0: Steam volume ST_1: Steam mass ST_3 : Saturated steam mass(pressure compensation)
71	Pressure acquisition mode setting	P_1: Pressure is automatic acquisition, should be use external silicon pressure sensor.

It provides two points calibration for the pressure sensor. If use HART-CONFIG Tool, please enter into 'Advanced Features' -> 'Temperature and Pressure Sensors' to trim the sensor.

You can also trim the sensor via local adjustment menu 74 and 75:

1. Set menu 04 and 71.
2. Apply zero pressure to the sensor, enter into menu 74, input the reference pressure(gauge pressure, unit kpa) to trim zero.
3. Apply full pressure to the sensor, enter into menu 75, input the reference pressure(gauge pressure, unit kpa) to trim full.

8.5.3 Low pressure cutoff value

If the pressure value is close to 0 is not stable, for example, varied between -0.01 and 0.01 kPa, may cause the output fluctuation. You can set 'Low pressure cutoff value' to remove this fluctuation.

If the measured pressure value is less than 'Low pressure cutoff value', it will set to be 0kpa.

8.5.4 Pressure bias settings

If there is a fixed pressure deviation, for example, the actual pressure value is 10kPa and the measured pressure value is 9.8kPa. You can perform ‘7.5.4 Pressure bias settings’ to remove this error.

Enter the current actual pressure value, to achieve bias.

8.5.5 Temperature Sensor Trim

If you want trim the temperature sensor, please check the flow mode and temperature acquisition mode setting.

character	Menu	Setting
04	Flow mode	Set one of the following: (The other modes do not collect temperature) GAS_0: Gas volume: GAS_1: Gas mass: ST_0: Steam volume ST_1: Steam mass ST_2 : Saturated steam mass (temperature compensation)
70	Temperature acquisition mode setting	t_1: Temperature is automatic acquisition, should be use external pt1000.

It provides two points calibration for the temperature sensor. We recommend use 1000ohm and 2500ohm resistors for calibration. If use HART-CONFIG Tool, please enter into ‘Advanced Features’ -> ‘Temperature and Pressure Sensors’ to trim the sensor.

You can also trim the sensor via local adjustment menu 72 and 73:

1. Set menu 04 and 70.
2. Apply lower resistor, such as 1000ohm, enter into menu 72, input the reference resistor value(1000) to trim..
3. Apply higher resistor, such as 2500ohm, enter into menu 73, input the reference resistor value(2500) to trim..
5. No.72 and No. 73 need to be adjusted, and guarantee the right temperature collection.
6. If really need use PT100, then it needs external 100 and 250 Ohm resistance, but if the input resistance value still 1000 and 2500, then use PT100 instead of PT1000.

IX. Vortex Flow Meter Installation Condition

9.1 Flange or wafer vortex flow meter installation notice

9.1.1Flow sensor should be horizontal or vertical installed(the liquid flow direction should be from bottom to top) on the pipeline, which is corresponding to the flow sensor nominal diameter.

9.1.2The definite straight pipeline length at upstream and downstream of flow sensor is required. The length should meet below table’s requirements:

Straight Pipeline Configuration

Upstream Straight pipe form	The Straight length of upstream	The Straight length of downstream
Concentric tube fully open valve	$\cong 12DN$	$\cong 5DN$
Concentric contraction fully open valve	$\cong 15DN$	
Single quarter bend	$\cong 20DN$	
Two quarter bends on the same surface	$\cong 25DN$	
Two quarter bends on the different surface	$\cong 40DN$	
Regulating valve、 Half-open gate valve	$\cong 50DN$	

9.1.3 At the upstream of flow sensor should not install a flow regulating valve.

9.1.4 If the length of upstream can not meet the requirement, we suggest that customer install a flow regulator at the side pipeline of upstream.

9.1.5 In order to avoid the accuracy, Flow sensor should be not installed on a strong vibration pipeline. If installation the flow sensor on a vibration pipeline, there are following methods to decrease the disturbing of vibration:

A. Installing a fixed support on pipeline at 2D upstream of flow sensor.

B. At the condition of meeting the straight length, install a hosepipe as a transmission.

9.1.6 Installation flow sensor on high temperature pipeline, if the heat preservation not good, the flow sensor should be installed downward vertical.

9.1.7 When the amendment is needed for temperature and pressure, it should install pressure tapping points at 3-5D downstream of flow sensor and temperature taking point at 5-8D downstream of flow sensor. (As the PIC 2)

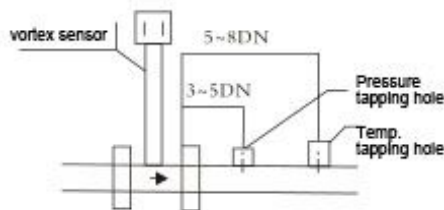

PIC 2

9.1.8 No collision by hard subject, when the flow sensor is installing, otherwise, the accuracy will be influenced, even flowmeter damaged.

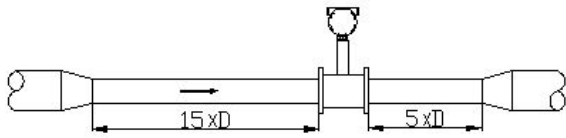

Concentric Reducers Pipeline

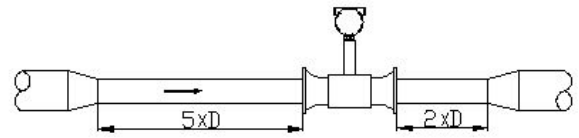

Concentric Reducers Pipeline

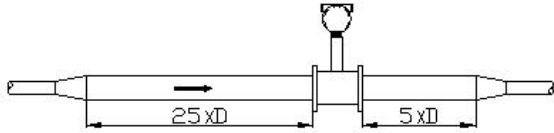

Concentric expansion pipeline

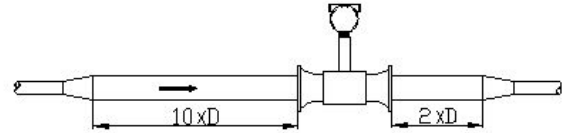

Concentric expansion pipeline

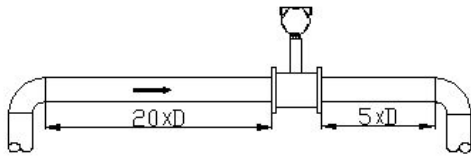

Single quarter bend

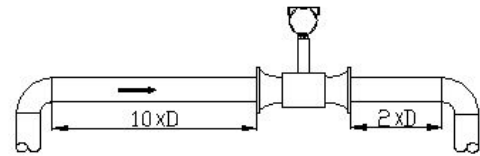

Single quarter bend

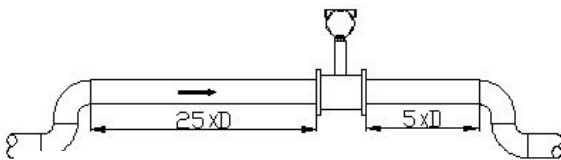

Two quarter bends on the same surface

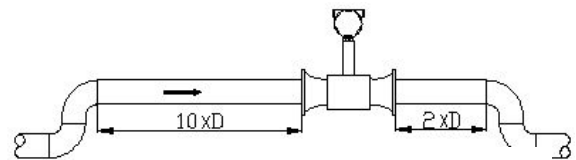

Two quarter bends on the same surface

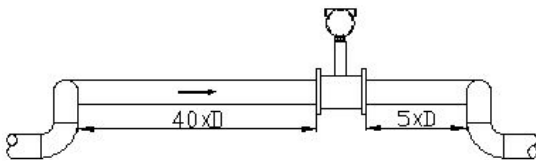

Two quarter bends on the different surface

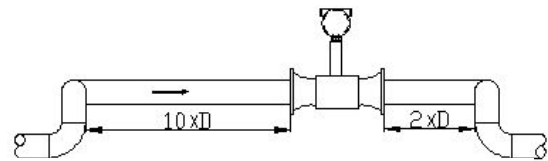

Two quarter bends on the different surface

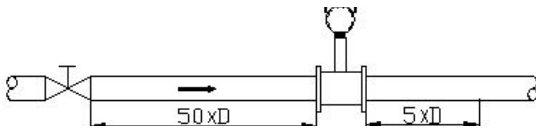

Regulating valve 、 Half-open gate

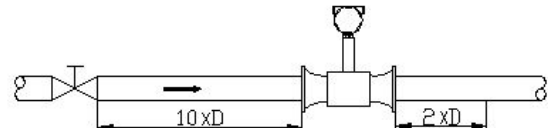

Regulating valve 、 Half-open gate

Pic 3 :Normal Pipeline

PIC 4 : With flow rectifier

9.2 Installing a insertion vortex flowmeter

On the pipeline should insure the upstream $\geq 15D$, downstream $\geq 5D$

1. Opening a $\Phi 100$ mm circular hole on the pipe line by gas cutting. the hole without rag to insure that the probe passes smoothly.

2. Welding flange short tube on the pipeline hole, pay attention to the vertical direction when welding. the effect after welding requires the axis and pipeline axis orthogonality and the extended line of flange short tube passing the cross-section circle center.

3. The Y length of Insertion rod below vortex flowmeter down connection flange, should be prevail to the real

external workshop. The users do not need to adjust it. In the special condition, computing the insertion depth should consider the length of straight pipeline and working condition medium, then making proper adjustment. When the straight pipeline length is enough and pipeline diameter above 400mm, can adopting average flow spot measurement, this method does not influence by the Reynolds number changing, probe insertion depth is $1/4D-1/3D$ (D for the diameter of pipeline). When the pipeline straight length is short and pipeline diameter less than or equal to 400mm, adopting center velocity flow spot measurement, the insertion depth $Y=0.5D$ (Reference drawing 6). After the measurement depth confirmed, adjusting insertion rod length, settling erosion point direction mark to make sure that the direction of vortex generator and flow direction in the pipeline is same, then connecting the flowmeter and bolts fixed joint on the flange short pipe.

4. Should install sealing gasket between flanges, rubber plate for normal temperature, high temperature can adopt the asbestos pad etc. heat-resisting material.

5. Assembling and disassembling method at the condition of non flow cutoff (with ball valve), when disassembling, first unscrewing stopper screw, then loosening the lock nut, pushing insertion rod upward until the probe is located the limiting position of ball valve top, now ball valve is closed. Then disassembling the top connecting flange, bolt and nut, finally taking the flowmeter away. The process of assembling is opposite to disassembling.

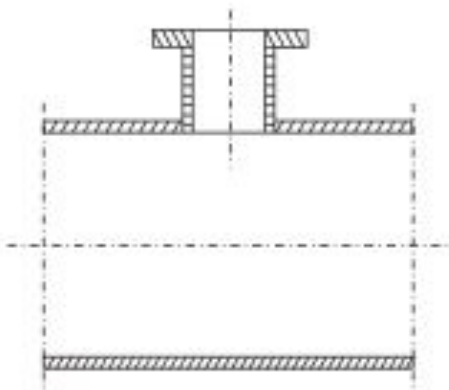

Right

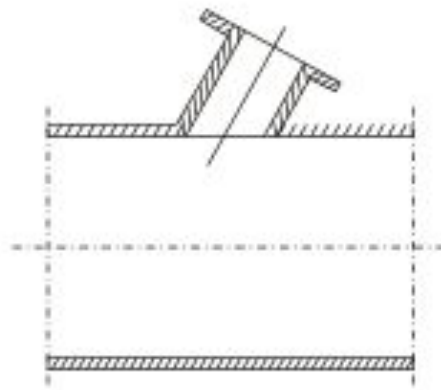

Wrong

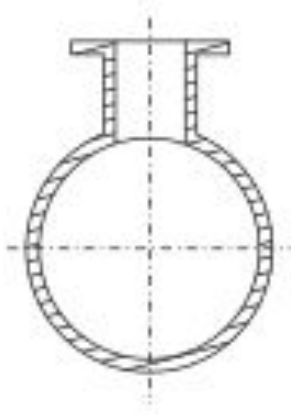

Right

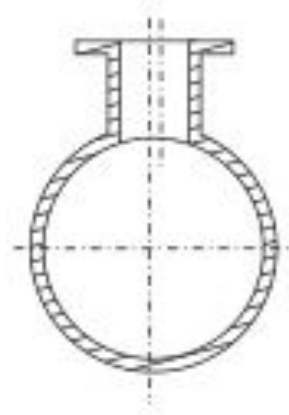

Wrong

PIC 6 The flange position of Insertion Vortex Flowmeter installed on pipeline.

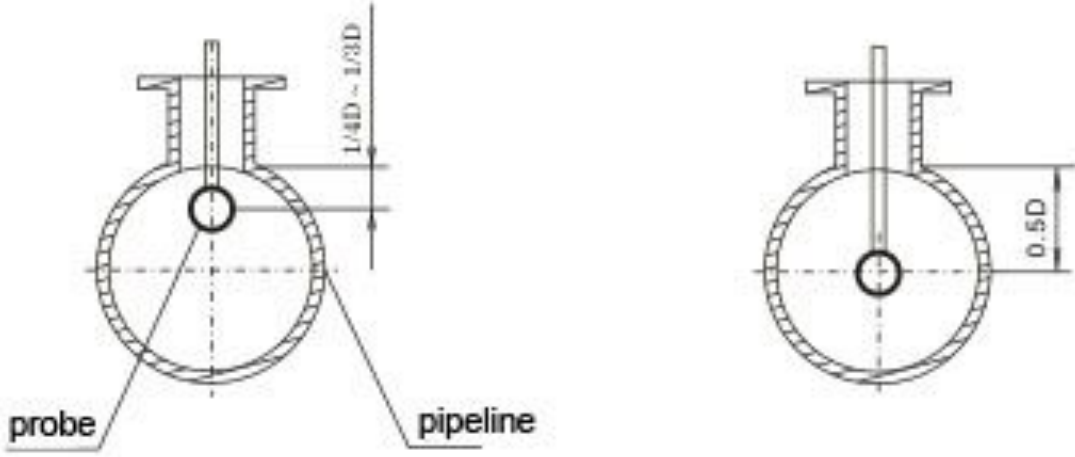

PIC 7 Insertion Position
(Insertion Depth is according to reservation real calibration)

9.2.3 Attention for installation:

- 1.The flow direction must be same as the flow indication rod, strictly forbidden to wrench the flow rod;
- 2.Flow transmitter is seted according to medium, flow range and nominal diameter, before using, it must inspect the parameter setting.
- 3.Removing burr and welding slag.
- 4.After wiring, make sure the flow converter cover and lead collar tight, in order to make sure the water proof and moisture proof.
- 5.Make sure that the shell of vortex flowmeter and lead shielding layer well grounded.



Perpa Ticaret Merkezi A-Blok Kat: 11 No: 1582

Okmeydanı – İstanbul

Tel: 0212 621 7200 – Faks: 0212 621 7201

E-mail: info@aktek.com.tr – Web: www.aktek.com.tr