



TTFM 6.1

Instruction Manual



Note: This page has been left blank intentionally.

CONTENTS

EU DECLARATION OF CONFORMITY	4
CONNECTIONS:.....	5
HAZARDOUS AREA WIRING INSTRUCTIONS.....	7
KEYPAD SYSTEM	8
MENU SYSTEM	9
ICONS.....	10
MESSAGES.....	11
STATUS.....	11
PASSWORD.....	13
MENU SELECTIONS.....	13
UNITS/MODE	14
SET UP	16
CALIBRATION.....	19
RELAY PARAMETERS.....	21
DATA LOGGING.....	22
COMMUNICATION (Optional).....	24
SPECIAL FUNCTIONS.....	26
TYPICAL SE16A SENSOR INSTALLATION	29
TYPICAL SE16B SENSOR INSTALLATION.....	30
TYPICAL SE16C SENSOR INSTALLATION	31
SENSOR MOUNTING.....	37
2 or 4 CROSS INSTALLATION OVERVIEW – SE16A Transducers TMK-A1 Kit.....	38
2 OR 4 CROSS INSTALLATION OVERVIEW – SE16B TMK-B1 Kit.....	41
1 CROSS INSTALLATION OVERVIEW – SE16B Transducers TMK-B1 Kit	45
2 OR 4 CROSS INSTALLATION OVERVIEW – SE16B Transducers TMK-B21 or TMK-B22 Kit	52
1 CROSS INSTALLATION OVERVIEW – SE16B Transducers TMK-B21 or TMK-B22 Kit	56
2 CROSS INSTALLATION OVERVIEW – SE16C Transducers TMK-C1 or TMK-C2 Kit	63
1 CROSS INSTALLATION OVERVIEW – SE16C Transducers TMK-C1 or TMK-C2 Kit	66
SENSOR MOUNTING/COUPLING RECOMMENDATIONS.....	72
ENCLOSURE INSTALLATION	73
FIELD TROUBLESHOOTING.....	74
COMMON QUESTIONS AND ANSWERS.....	77
APPLICATIONS HOTLINE.....	79
PRODUCT RETURN PROCEDURE.....	79
APPENDIX A – Classified Area Installation Control Drawings	83
APPENDIX B – Specifications	91
APPENDIX C – Pipe Charts.....	94
APPENDIX D – Speed of Sound for Various Fluids	99
APPENDIX E – Speed of Sound of Water Relative to Temperature.....	107

IMPORTANT NOTE: This instrument is manufactured and calibrated to meet product specifications. Please read this manual carefully before installation and operation. Any unauthorized repairs or modifications may result in a suspension of the warranty. If this product is not used as specified by the manufacturer, protection may be impaired. Available in Adobe Acrobat pdf format.

EU DECLARATION OF CONFORMITY

EU Declaration of Conformity – Pulsar Measurement TTFM 6.1 Transit-Time Flow Meter

This declaration of conformity is issued under the sole responsibility of the manufacturer.

Relevant Directive(s)	2014/30/EU – EMC directive and its amending directives 2014/35/EU – Low Voltage directive and its amending directives 2014/34/EU – ATEX directive and its amending directives 2011/65/EU – RoHS directive and its amending directives
Manufacturer’s name	Pulsar Measurement
Manufacturer’s address	16456 Sixsmith Drive Long Sault, ON K0C 1P0 Canada
Apparatus	Transit-time flow meter including wall-mount electronics, transducer cables, and transducers
Models	TTFM 6.1 with SE16A, SE16B, or SE16C transducers (ATEX where approved)
Type of equipment	Measurement and process control
Standards applied	EN 61326-1:2013 EMC, equipment class industrial EN 61010-1:2010+A1:2019 Safety requirements for electrical equipment for measurement, control, and laboratory use EN IEC 60079-0:2018 ATEX general requirements EN 60079-11:2021 ATEX intrinsic safety (Ex ia)
Notified body	CSA Group Netherlands B.V. #2813
Role	Certifier of ATEX type examination CSANe 22ATEX1057X

I declare that the apparatus named above has been tested and complies with the relevant sections of the above referenced standards & directives.

Signed:



Date: November 16, 2022

Rev. 1.0

Name & function

Ken Elander, Sr Product
Manager

Pulsar Measurement

CONNECTIONS:

POWER INPUT: The standard model requires AC power input between 100 to 240 VAC 50/60Hz 10VA. No adjustments are necessary for voltages within this range. Connect L (Live) N (Neutral) and AC Ground.

Optional DC input model requires 9-32 VDC/10 Watts. Connect to + and - terminals.

Optional Thermostat and Heater modules are available rated for specifically 115 VAC or specifically 230 VAC.

IMPORTANT NOTE: To comply with electrical safety standards, AC power input and relay connection wires must have conduit entry to the instrument enclosure. Installation requires a switch, overcurrent fuse or circuit breaker in the building (in close proximity to the equipment) that is marked as the disconnect switch.



Risk of electric shock. Loosen cover screw to access connections. Only qualified personnel should access connections.

Note: Use of instrumentation over 40°C ambient requires special field wiring.

100-240 VAC Meter CONNECTIONS

For sensors being installed in ordinary locations, or where CSA C/US Non-Incendive for Class I, Div 2, Groups A, B, C, D certification applies, electronics housing connections are as follows:

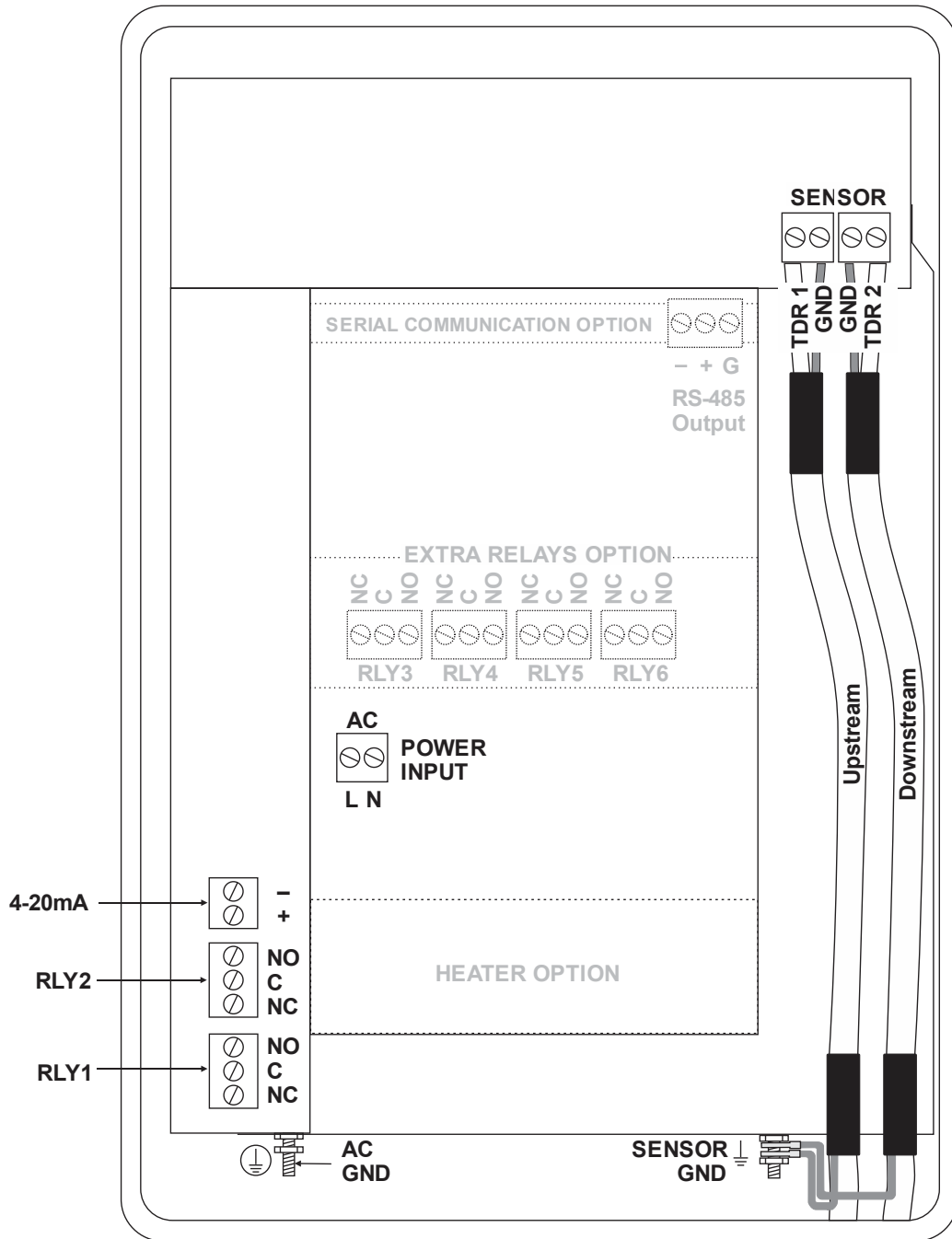

HAZARDOUS AREA WIRING INSTRUCTIONS

The SE16A, SE16B, and SE16C transducers come certified for use in the following hazardous locations. Please visit our website for copies of the approval letters from the certifying agencies.

Individual copies of the specific control drawings for proper installation are also available for download on the website, included with the shipment of each meter as a stand-alone document, and located within this manual in Appendix A.

Standard:

- CSA C/US Non-incendive for Class I, Div 2, Groups A, B, C, D

Optional with Intrinsic Safety Barriers:

- CSA C/US Intrinsically safe for Class I, Div 1, Groups C, D; Class II, Div 1 Groups E, F, G; Class III; Encl. Type 4
or
- ATEX/IECEX Zone 0, Ex ia IIB T4 Ga

When using optional intrinsic safety barriers, follow the instructions in the control drawings for proper adherence to the conditions of acceptability. When the intrinsic safety barrier option is purchased with the TTFM 6.1, the proper barriers come pre-installed inside the TTFM 6.1 electronics housing.

KEYPAD SYSTEM

The diagram on page 7 shows the TTFM 6.1 menu system. Arrows show the four directions to leave a menu box. Pressing a corresponding keypad arrow will move to the next item in the direction shown. Move the cursor (highlighted) under numerals and increase or decrease numerals with the ▲ and ▼ keys.

To store calibration values permanently (even through power interruptions), press the ✓ button.

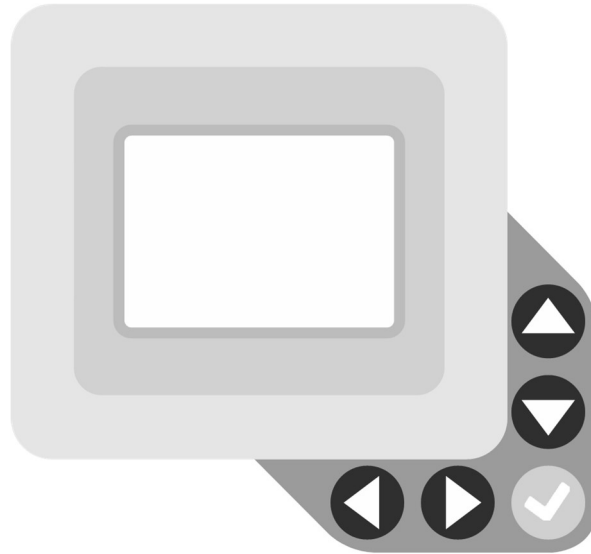

MENU SYSTEM

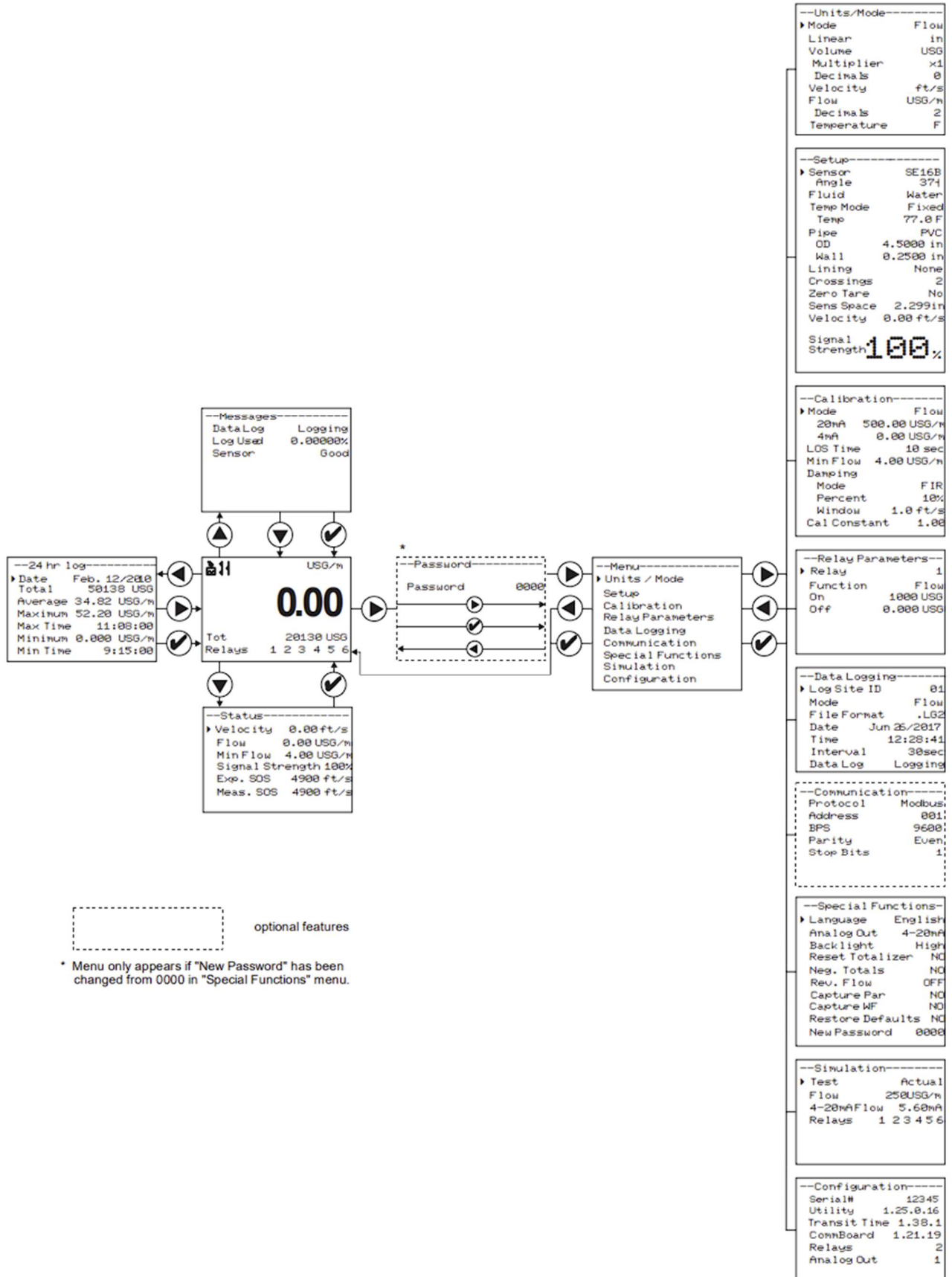

ICONS



1.



2.

Message waiting. Press ▲ from main page to view.



Data logging off.



1.



2.

Data logging on.



1.



2.



3.



4.

USB file downloading.



File download completed.



Download Error.



1.



2.



3.

TTFM Echo OK.



TTFM -Low Signal / No Echo, Empty Pipe or high Aeration.



TTFM - No Sensors Attached / Wrong Settings

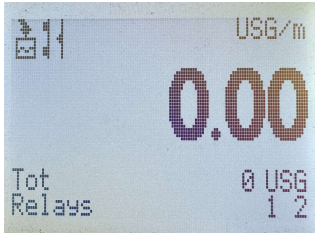

MAIN DISPLAY

The Main Display shows the units selected from the Units/Mode menu, flow rate or velocity rate being measured, totalizer, totalizer multiplier, and relay states. The TTFM 6.1 will go to this display after start-up.

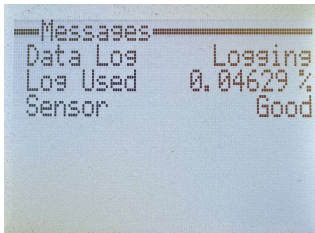

MESSAGES

Press ▲ from the Main Display to view status of the data logger and error/warning messages provided by the instrument. The Message Icon will appear on the Main Display if error messages are being generated by the instrument. Press ✓ to return to the Main Display.

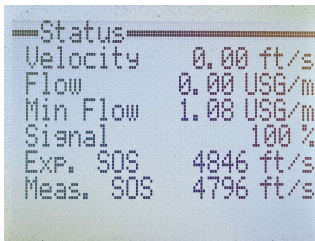

STATUS

Press ▼ from the Main Display to view Status of the measurement. Press ✓ to return to the Main Display.

Velocity Displays flow velocity in ft/s or m/s, selected in the Units/Mode menu.

Flow Displays flow rate in units selected in the Units/Mode menu. A list of flow rate units is provided in the Units/Mode section of the manual.

Min Flow Displays a read-only value for the minimum flow cutoff, in units which match the Flow selection. Measured flow rates below the Min Flow will result in the displayed flow rate on the LCD display to be 0.0. This parameter is used to suppress electrical noise at zero flow conditions, and it is typically set to the flow rate equivalent of 0.1 ft/sec in the programmed pipe size. The Min Flow can be adjusted in the Calibration menu.

Signal Strength Displays magnitude of signal being received by the ultrasonic sensors. 100% is the ideal signal strength. Signal strengths less than 100% could indicate poor pipe conditions (corrosion), highly aerated water, or programmed setup parameters which don't closely match field conditions. Consideration should be made to use 1-cross installation method in such cases, if not already using it.

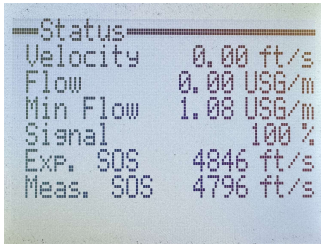

STATUS (cont.)

Exp. SOS

Displays the expected fluid speed of sound measurement, in units that match the Velocity. The expected speed of sound is based on the pipe, fluid, and temperature selection in the Setup menu.

Meas. SOS

Displays the measured fluid speed of sound, in units that match Exp. SOS. The meter calculates this value based on the time it takes for the signal to arrive from one transducer to another. Large differences between expected and measured speed of sound (> 10%) typically indicate an error in the setup of the instrument. Verify the following are correct in the Setup menu and with the physical installation of the transducers:

- Pipe Material
- Pipe OD
- Pipe Wall Thickness
- Liner Type
- Liner Thickness
- Fluid Type
- Fluid Temperature
- Crossings
- Separation Distance

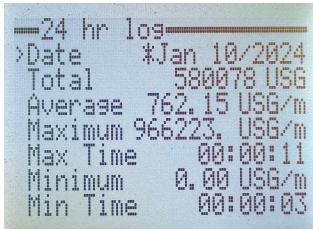

24 HR LOG

Press ◀ from the Main Display to view a formatted flow report. Press ▼ to scroll down one day or repeatedly to scroll to a specific date. Up to 365 days will be stored. Newest date will overwrite the oldest. Press ✓ to return to the Main Display.

IMPORTANT: Inserting a USB drive into the meter while on this screen will transfer the last 365 days worth of 24 HR Log data to the USB drive in .csv format.

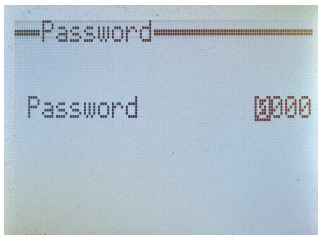

PASSWORD

The Password (a number from 0000 to 9999) prevents unauthorized access to the Calibration menu.

From the Main Display press the ▶ key to get to Password. Factory default password is 0000 and if it has not been changed, this screen will be bypassed completely.

A new password can be stored by going to the Special Functions New Password menu.

If a user password is required, press ▶ to place the cursor under the first digit and ▼ or ▲ to set the number, then ▶ to the second digit, etc. Press ▶ or ✓ to proceed to the Menu Selections screen.

MENU SELECTIONS

The Menu selections page is used to navigate to specific menus which are described in more detail on the following pages.

Press ▲ or ▼ to navigate to different menus, and ▶ to enter the selected menu.

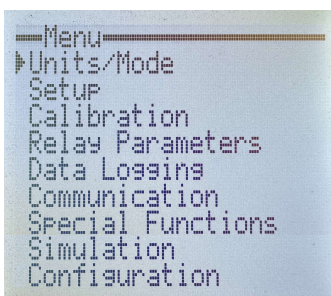

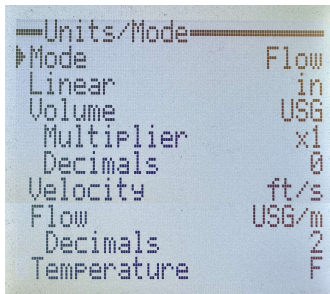

UNITS/MODE

At Mode, press the ► and then the ▲ or ▼ to select Flow or Velocity. Flow mode displays the flow rate in engineering units (e.g. gpm, litres/sec, etc.) Press the ✓ to store your selection then the ▼ to the next menu item.

At Linear, press the ► key and then the ▲ or ▼ to select your units of measurement. The Linear units define what units the pipe dimensions and sensor spacing will be displayed in. Typically inches or mm is selected. Press the ✓ to store your selection then the ▼ to the next menu item.

At Volume, press the ► and then the ▲ or ▼ to select units for volume. Note: "bbl" denotes US oil barrels. Press the ✓ to store your selection then the ▼ to the next menu item.

At Multiplier, press the ► and then the ▲ or ▼ to select the totalizer multiplier. Multipliers are used when resolution down to single digit is not required, or when you don't want to convert from gallons to thousands of gallons, as an example. Press ✓ to store your selection then ▼ to the next menu item.

At Decimals (Volume), press the ► and then the ▲ or ▼ to select the number of decimal points to be present on the totalizer display on the LCD screen. Default = 0. Options = 0, 1, 2. Press the ✓ to store your selection then the ▼ to the next menu item.

At Velocity, press the ► and then the ▲ or ▼ to select the engineering units for flow velocity and sonic velocity of the fluid. Press ✓ to store your selection then ▼ to the next menu item.

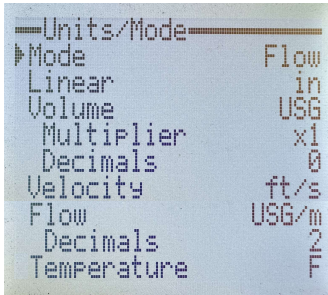

UNITS/MODE (cont.)

At Flow, press the ► and then the ▲ or ▼ to select the engineering units for flow rate. Press ✓ to store your selection then ▼ to the next menu item.

Available Flow Rate Engineering Units:

Abbreviation	Description	Abbreviation	Description
USG/d	US gallons per day	L/d	liters per day
USG/h	US gallons per hour	L/h	liters per hour
USG/m	US gallons per minute	L/m	liters per minute
USG/s	US gallons per second	L/s	liters per second
ft ³ /d	cubic feet per day	m ³ /d	cubic meters per day
ft ³ /h	cubic feet per hour	m ³ /h	cubic meters per hour
ft ³ /m	cubic feet per minute	m ³ /m	cubic meters per minute
ft ³ /s	cubic feet per second	m ³ /s	cubic meters per second
bbl/d	barrels per day (1 bbl = 42 USG)	IG/d	Imperial gallons per day
bbl/h	barrels per hour (1 bbl = 42 USG)	IG/d	Imperial gallons per day
bbl/m	barrels per minute (1 bbl = 42 USG)	IG/d	Imperial gallons per day
bbl/d	barrels per second (1 bbl = 42 USG)	IG/d	Imperial gallons per day
USMG/d	US million gallons per day	IMG/d	Imperial million gallons per day
USMG/h	US million gallons per hour	IMG/h	Imperial million gallons per hour
USMG/m	US million gallons per minute	IMG/m	Imperial million gallons per minute
USMG/s	US million gallons per second	IMG/s	Imperial million gallons per second

At Decimals (Flow), press the ► and then the ▲ or ▼ to select the number of decimal points to be present on the flow rate display on the LCD screen. Default = 2. Options = 0, 1, 2. Press the ✓ to store your selection then the ▼ to the next menu item.

At Temperature, press the ► and then the ▲ or ▼ to select units for temperature. Press the ✓ to store your selection then the ▲ to go back to another menu item, or ◀ to exit back to the Menu Selection screen.

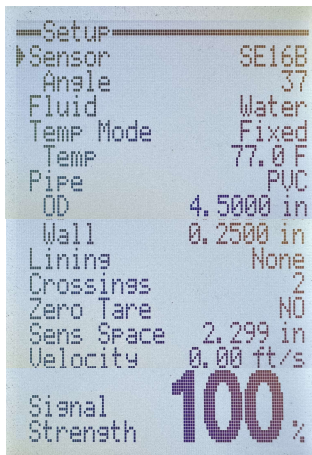

SET UP

Press ▼ or ▲ to position cursor at Setup, and ► to enter. Use ▼ or ▲ to position cursor before each menu item and ► to enter. When settings are completed press ✓ to store and ✓ again to return to the Main Menu.

Sensor Select Choose SE16A, SE16B, or SE16C, depending on transducers connected to TTFM 6.1.

Angle For SE16B only, select angle which matches the transducer pair connected to the TTFM. Options: 35, 37, 39, and 41. Angle is determined by the part number on the SE16-B transducer label. For SE16A and SE16C, Angle should be 37.

Part Number on SE16-B Label	Corresponding Transducer Angle
SE16-B-35	35
SE16-B-37	37
SE16-B-39	39
SE16-B-41	41

Fluid Select fluid type.

Vel@25C When Fluid = Other, enter the fluid velocity at 25C from table or other reference. Engineering units may be m/s or ft/s depending on Units menu programming.

dV/C When Fluid = Other, Enter fluid velocity adjustment factor over change in temperature in units of m/s or ft/s per °C.

Temp Mode Choose Fixed.

Temp Enter fluid operating temperature in displayed engineering units.

Pipe Select pipe material.

Pipe Vel When Pipe = Other, enter pipe material speed of sound (consult factory).

OD Highlight the digits and then ▲ or ▼ to change the numbers and decimal point. Pipe OD should be entered as the exact outside diameter of the pipe where the sensor is mounted. Refer to the Pipe Charts Appendix in this manual for outside diameter of common pipe types and sizes.

Wall Enter pipe wall thickness. Pipe wall thickness should be entered as the exact wall thickness of the pipe where the sensor is mounted. Refer to the Pipe Charts Appendix in this manual for wall thicknesses of common pipe types and sizes.

Lining Select liner material.

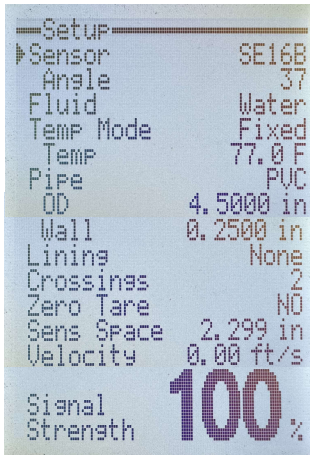

SET UP (cont.)

Vel When Lining = Other, enter speed of sound of liner (consult factory).

Thick When Lining ≠ None, enter liner thickness.

Crossings

Crossings 1 = Z
mounting

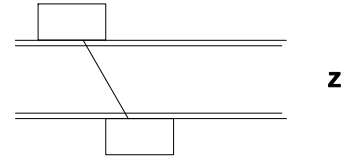

Crossings 2 = V
mounting

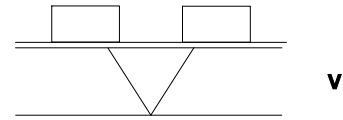

Crossings 4 = W
mounting

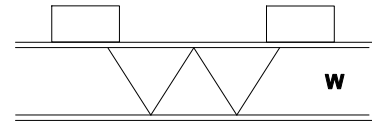

Nominal Pipe Size, in	Recommended Crossing, SE16A	Recommended Crossings, SE16B	Recommended Crossings, SE16C
0.5-1.5	4	N/A	N/A
2-3	2	2	N/A
4-6	2	2	2
8-10	N/A	2	2
12-24	N/A	2	2
26-48	N/A	1	2

Older pipes are often degraded or scaled on the inside. These conditions can hinder the ability to receive a strong signal when Crossings = 4 or 2. We suggest starting with Crossings = 2 or 1, respectively, in these cases.

Zero Tare Used to calibrate zero-flow measured by the TTFM 6.1 in process. Flow in the pipe should be confirmed as 0 before enabling, or significant errors in flow accuracy could occur. Set Calibration/Damping to 0%, and under no flow conditions and with a full pipe, select Yes to force readings to zero.

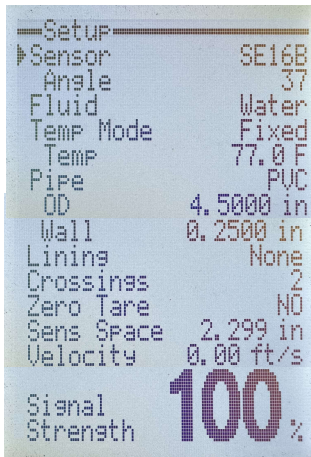

SET UP (cont.)

- Sens pace** After sensor, angle, fluid, and pipe material are defined, this displays the calculated sensor spacing. Also called the separation distance. The sensors will be set to this dimension when installed on the pipe, as described later in this manual.
- Velocity** Displays the measured velocity after the sensors have been connected at the specified separation distance.
- Signal Strength** Displays magnitude of signal being received by the ultrasonic sensor. Should be 100% under ideal operating conditions. Signal strengths less than 100% do not indicate that the meter is not reliable, however, the meter may be more susceptible to complete signal loss should process conditions like entrapped air worsen. When signal strength is less than 100%, consideration should be made to using 1-cross mounting method if this is not the current mounting mode.

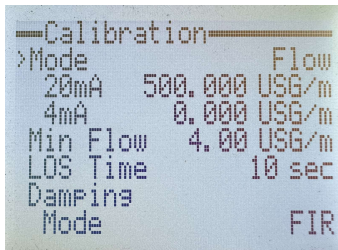

CALIBRATION

Press ▼ or ▲ to position cursor at Calibration menu, and ► to enter. Use ▼ or ▲ to position cursor before each menu item and ► to enter. When settings are completed press ✓ to store and ✓ again to return to the Main Menu.

Mode	Displays the Mode which was selected in the Units/Mode menu. This is read-only.
20mA	Press ► then ▼ or ▲ to change the numbers and decimal point position. Use this menu to set the corresponding flow rate that will be represented by 20mA analog output. If maximum flow is unknown, enter an estimated flow rate and observe actual flow to determine the correct maximum value. Any velocity or flow rate up to +40 ft/sec (12.0 m/sec) may be selected.
4mA	Press ► then ▼ or ▲ to set the flow rate corresponding to 4mA analog output. This setting may be left at zero or can be raised to any value less than the 20mA setting, or lowered to any velocity or corresponding flow rate down to -40 ft/sec (-12 m/sec).
LOS Time	Use LOS Time to suppress intermittent loss of signal. Example: systems with high concentrations of undissolved gasses will cause fluctuations in signal strength when the gasses move past the ultrasonic signal. If a complete loss of signal is experienced, the TTFM 6.1 will hold the last valid reading for the duration of the LOS Time. If the signal strength returns before the LOS Time is expired, because the ultrasonic signal is no longer being impeded, the meter will return to normal operation automatically. If signal strength does not return after the LOS Time has expired, then the meter will report zero flow on the LCD display and outputs and produce a Low Signal alarm. Default LOS Time is 30 seconds, and the value can be set between 0 and 99 seconds.
Min Flow	Flow rates below this setting will be displayed as zero flow. Default flow rate is ~ 0.1 ft/sec for the pipe size programmed in the Setup menu.

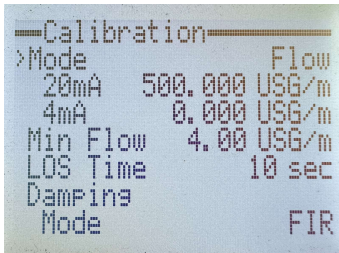

CALIBRATION (cont.)

Damping
Mode Choose between OFF, FIR (Default), or LOW PASS.

When measured flows are outside the Window of the running average, the FIR filter will reduce the damping average so that a fast response can be made to the sudden change in flow rate.

The LOW PASS filter will ignore measured flow rates outside the Window, while holding the running average, until there are enough data points outside the Window to cause a step-response to the new measured value.

While measured flows are within the Window of the running average, both the FIR and LOW PASS filter behave the same.

Percent Higher percentages increase the number of measurements which are averaged together to produce a stable flow reading. Higher percentages also increase the time it takes for the meter to make a step-response to the measured flow rate outside the Window in the LOW PASS Mode.

Window Defines the Window around the running average, in units of Velocity set in the Units/Mode menu. Measurements made inside the Window are added to the running average, and measurements outside the Window effect the response of the meter as described in the Mode section.

Cal Constant Calibration constant defined when the TTFM was calibrated at the factory.

Press ✓ to return to Menu Selections.

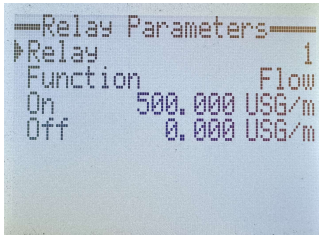

RELAY PARAMETERS

Press ▼ or ▲ to position cursor at Relay Parameters, and ► to enter. Use ▼ or ▲ to position cursor before each menu item and ► to enter. When settings are completed press ✓ to store and ✓ again to return to the Main Menu.

Relay Press ► and ▼ or ▲ to select a corresponding relay number (2 relays are standard, 4 additional are optional).

Function Press ▼ or ▲ to select Off, On, Pulse, Direction, Flow, or LOS.

Pulse Press ▼ and set digits to the flow volume increment required between relay pulses. Use this feature for remote samplers, chlorinators or totalizers. Minimum time between pulses is 2.25 seconds and pulse duration is 350 milliseconds.

Return to **Relay** and change settings for each relay number.

Press ✓ to return to **Menu Selections**.

Direction When flow is in the positive direction, the relay will be disengaged, when flow is negative, the relay engages.

Note: Rev. Flow in the Special Functions menu must be ON or INVERT for this to work properly.

Flow Mode Select Pump

Pump mode provides separate On/Off settings where the relay will energize at one flow rate and de-energize at another.

On Highlight the numerals and press ▼ or ▲ to set digits to the required relay **On** set point.

Off set digits to the required **Off** set point.

LOS Stands for "Loss of Signal"

This function operates by latching the selected relay ON when a Loss of Signal (LOS) occurs. An LOS consists of any state other than Sensor Good. This includes Sensor Short, Sensor Open, Low Signal, or System Fault.

NOTE: Mind the LOS Time parameter in the Calibration menu, as it has a direct impact on the TTFM's response time to a loss of signal state.

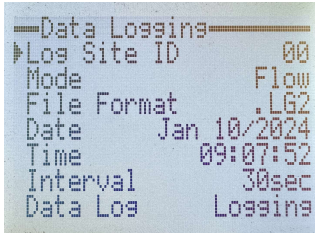

DATA LOGGING

Press ▼ or ▲ to position cursor at Data Logging, and ► to enter. Use ▼ or ▲ to position cursor before each menu item and ► to enter. When settings are completed press ✓ to store and ✓ again to return to the Main Menu.

- | | |
|-------------|--|
| Log Site ID | Enter a number from 00 to 99. The site ID will become part of the downloaded file name to help distinguish downloads from different instruments. Press ✓ to store the setting. |
| Mode | Select Velocity (e.g. ft/sec or m/sec) or Flow (e.g. USGPM or l/sec). Press ✓ to store the setting. This setting cannot be changed after a log was started. To change, first stop the log, then change the mode. |
| File Format | Choose .LG2 to download data in .lg2 format for viewing on Greyline Logger software. Choose .CSV to download data in .csv format for import directly to Excel. This menu option can be changed at any time without adversely affecting existing data. |
| Date | Press ►, and ▲ or ▼ to scroll and select Month, Day and Year. Press ✓ to store the setting. |
| Time | Press ►, and ▲ or ▼ to select the current time in Hours, Minutes and Seconds. Press ✓ to store the setting. |
| Interval | Press ▲ or ▼ to select the logging interval. Press ✓ to store the setting. Pulsar Measurement recommends choosing an interval which will give you as much resolution as required and no more. Choosing too often of an interval for what is required will result in larger data files, which may take a long time to download to USB. Reference page 18 for specific download times. In critical installations, data should be downloaded often. |
| Data Log | Stop, Start or Delete the log file. Press ▲ or ▼ to select Delete and ✓ to delete the log file. Press ▲ or ▼ to select Start and ✓ to start the logger. |

Important Note: You MUST Delete an old log and Start a new log AFTER having made changes to Log Site ID, Mode, Date, Time and/or Interval for those changes to be applied.

Important Note: Changing any of the parameters in the Units/Mode menu will start a new log. It is recommended that you Delete and start a new log after changing any Units/Mode settings.

RETRIEVING LOG FILE

Plug a USB Flash Memory Drive (one is included with the TTFM 6.1) into the USB output port on the Panel of the meter. The instrument display will show the data download icon until the log file is transferred to the memory card. The USB flash drive may be removed when the icon for download successful appears.

Download file names will appear in this format:

TTFM_ _00A.LG2
 ↑ ↑ ↑
 MODEL TAG DOWNLOAD

Tag is set according to the Log Site ID entered in the instrument Data Logging menu.

Download letter will be A for the first download from an instrument. B for the second, then C etc. At the letter Z a - character will appear indicating that the maximum number of downloads for that instrument are on the USB flash drive.

Older files can be erased or moved from the flash memory drive or a new memory drive can be used.

Note: Downloading files in .lg2 format will take approximately 35 seconds per 1% of internal log memory used.

Downloading files in .csv format will take approximately 8 minutes per 1% of internal log memory used.

OPENING .LG2 FILES

Install Greyline Logger on your PC or laptop. Select File/Open/Instrument Log (.log) to open the log file from your USB flash drive. Greyline Logger Software is available for download on the Pulsar Measurement website, www.pulsarmeasurement.com/downloads. Data can also be converted to .CSV via Greyline Logger software.

OPENING .CSV FILES

Use a datasheet program such as Microsoft Excel® to import data in a comma delimited format. Use Excel to manipulate or graph data.

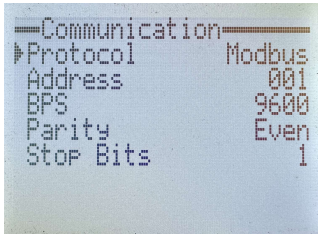

COMMUNICATION (Optional)

Press ▼ or ▲ to position cursor at Communication, and ► to enter. Use ▼ or ▲ to position cursor before each menu item and ► to enter. When settings are completed press ✓ to store and ✓ again to return to the Main Menu.

MODBUS Protocol Information:

- Transceiver: 2-wire, half-duplex
- Data format: 8 Data Bits
- Floating: ABCD
- Point Byte
- Order:
- Termination: Jumper JP1 selectable 120Ω resistor. TB1 & TB2 = OFF, TB2 & TB3 = ON
- Biasing: None

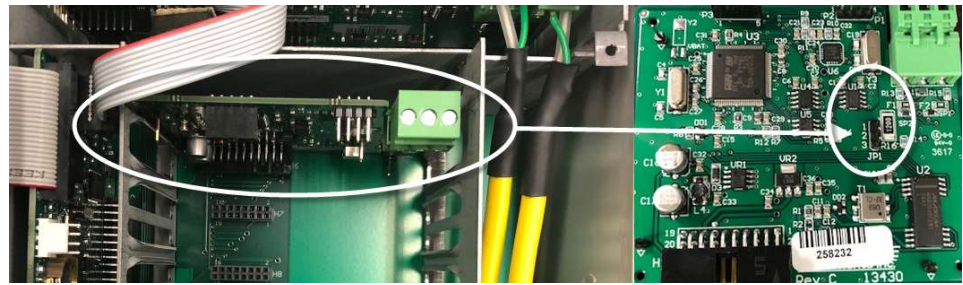

HART® (Highway Addressable Remote Transducer) Protocol Information:

- HART Version: 7.0
- Device Description Files: DD files allow the user’s handheld HART communicator to fully configure the TTFM 6.1 Pulsar Measurement provides DD files for the Emerson 475 Communicator. The files are included in the USB drive provided with your TTFM 6.1 meter. You may also request the files from Pulsar Measurement by calling or emailing us at info@pulsarmeasurement.com.
- Warning:** The TTFM 6.1 and associated DDs are pending certification from the Fieldcomm Group.

Connections: HART Protocol uses a digital signal superimposed on the 4-20mA output. When the 4-20mA output of the TTFM 6.1 is connected with a load resistor (230Ω to 600Ω), the HART communicator can be connected on the loop in order to communicate.

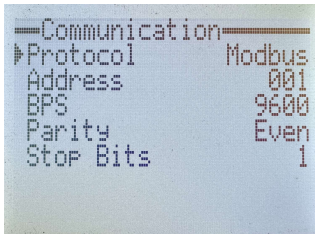

COMMUNICATION (Optional) (cont.)

Protocol	Choose MODBUS or HART.
Address (Modbus)	Device address for the TTFM. Valid range: 001-247 (Default: 001). This number should be unique across the bus. Press ▲ or ▼ to scroll, ► to select digits, and press ✓ to store the setting.
BPS (Modbus)	Baud rate for the MODBUS communications. Press ▲ or ▼ to select, and ✓ to store the setting. Options: 4800, 9600, 19200, 38400, 57600, 76800, and 115200 (Default: 9600).
Parity (Modbus)	Error checking parity for the MODBUS communications. Press ▲ or ▼ to select, and ✓ to store the setting. Options: None, Even, and Odd (Default: Even).
Stop Bits (Modbus)	Press ▲ or ▼ to select, and ✓ to store the setting. Options: 1 or 2 (Default: 1).

Note: The Modbus register table, and HART configuration instructions can be found in separate TTFM 6.1 Serial Communications Manual.

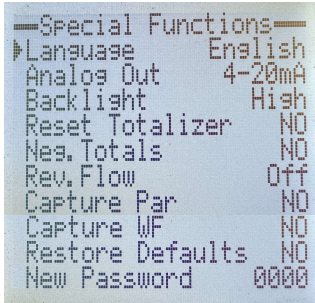

SPECIAL FUNCTIONS

Press ▼ or ▲ to position cursor at Special Functions, and ► to enter. Use ▼ or ▲ to position cursor before each menu item and ► to enter. When settings are completed press ✓ to store and ✓ again to return to the Main Menu.

Language Select English, French or Spanish

Analog Out Select 4-20mA or 0-5V mode for the analog output.

Backlight Select High, Medium or Low for continuous backlight brightness.

Select Key Hi/Lo for high backlight lasting 1 minute after a keypress, and then Lo backlight until a key is pressed again.

Select Key High, Med or Low for backlight lasting 1 minute after a keypress and then backlight off until a key is pressed again.

Reset Totalizer Select Yes to erase and restart the totalizer at zero.

Negative Totals Select Yes to have reverse flow readings deducted from the totalizer. Select No to totalize forward flow only and ignore reverse flow.

Rev. Flow Select On to enable flow direction measurement. Select Off to disable flow direction measurement so that flow in either direction is displayed and output as positive values.

Select Invert to invert the sense of the flow measurement.

Capture Par This function captures the programming parameters in the meter. Select Yes, wait for Insrt USB to appear, then insert a USB drive into the USB port to transfer the parameters. After Saving flashes, Done will appear on the screen, meaning it is safe to remove the USB.

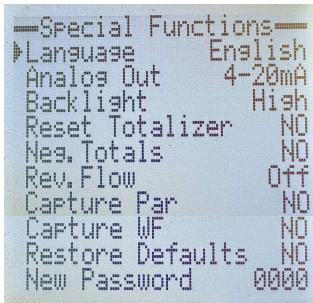

SPECIAL FUNCTIONS (cont.)

Capture WF This function should only be used when instructed by a Pulsar Measurement representative to do so. The function captures the ultrasonic signal so that it can be evaluated by Pulsar Measurement.

Select Yes to start the waveform download process. After pressing Yes, the screen will flash Working for approximately 20 seconds, until the message Insrt USB appears. When Insrt USB is on the screen, connect a flash drive to the USB port on the front of the meter. The screen will flash Saving for a couple seconds, and then return to Done. The waveform is now stored on your flash drive and ready to be sent to Pulsar Measurement.

Restore Defaults Select Yes to erase all user settings and return the instrument to factory default settings. Note: does not reset factory calibration values.

New Password Select any number from 0000 to 9999. Default setting of 0000 will allow direct access to the calibration menus. Setting any password other than 0000 will require the password to be entered to access the calibration menus.

Press ✓ to return to Menu Selections.

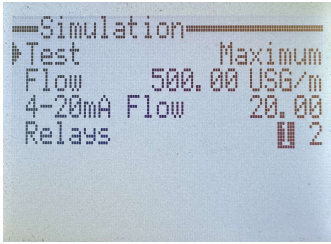

SIMULATION

Press ▼ or ▲ to position cursor at Simulation, and ► to enter. Use ▼ or ▲ to position cursor before each menu item and ► to enter. When settings are completed press ✓ to store and ✓ again to return to the Main Menu.

Changes made in the Simulation menu exercise the 4-20mA output, digital display and control relays.

Simulate a Flow /Velocity reading. Press ► and then ▼ or ▲ to change the simulated output. Press ✓ to begin simulation. The 4-20mA output and relay states will be displayed on the screen below.

Press the ✓ to terminate simulation and return to the Menu Selections screen.

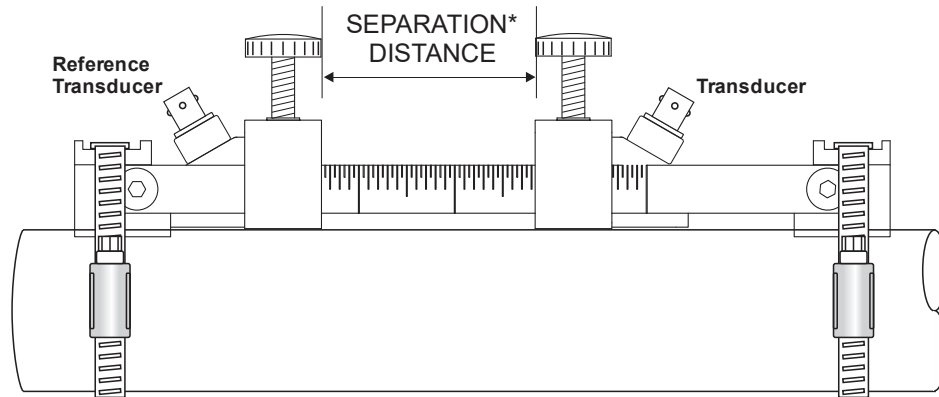
TYPICAL SE16A SENSOR INSTALLATION**2 or 4 Cross Separation Distance**

* Shown in 'Set up' menu after sensor, fluid and pipe parameters are entered.

Separation distance is measured from transducer face to transducer face.
Reference transducer is placed flush to bracket.

Mount the supplied SE16A Series Transducers on pipes 0.5" / 15 mm OD or larger.

Transducers should be installed with the cable connections pointed away from each other.

TYPICAL SE16B SENSOR INSTALLATION

2 Cross Separation Distance

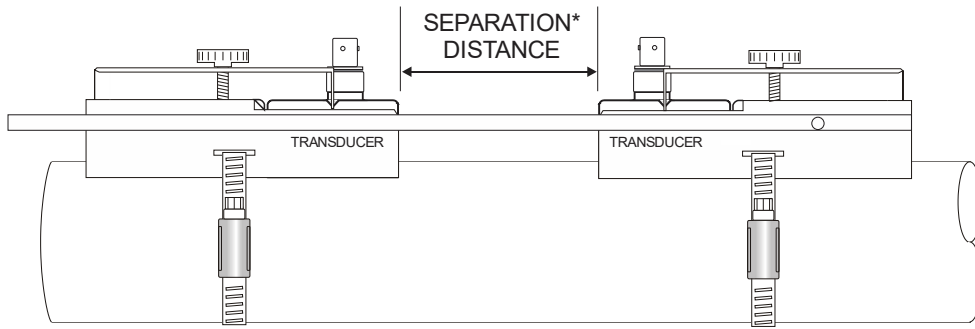

1 Cross Separation Distance

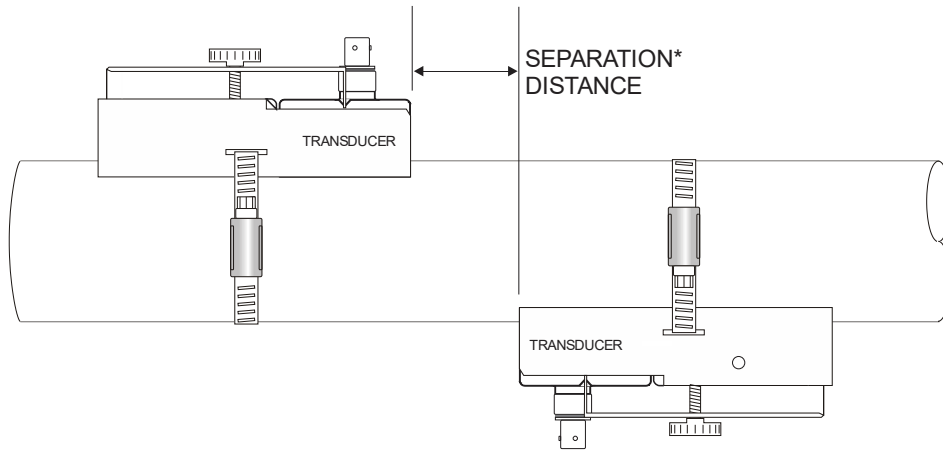

* Shown in 'Set up' menu after sensor, fluid and pipe parameters are entered.

TMK-B1 transducer mounting kit shown. Sensor spacing method is consistent with TMK-B21 and TMK-B22 kits, but the brackets will be different.

Arrows on top of transducers should be pointed towards each other:

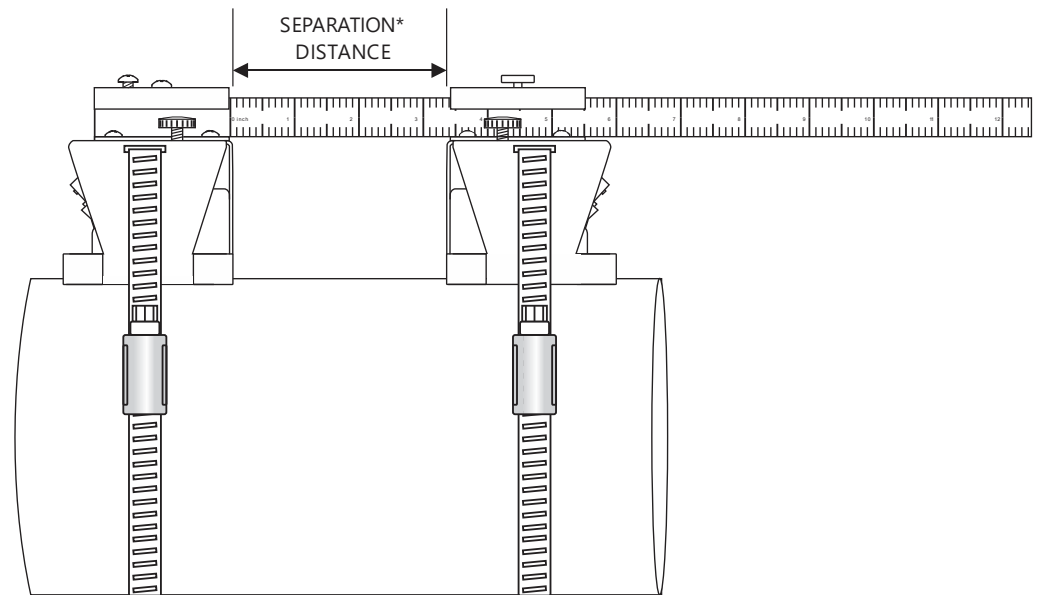
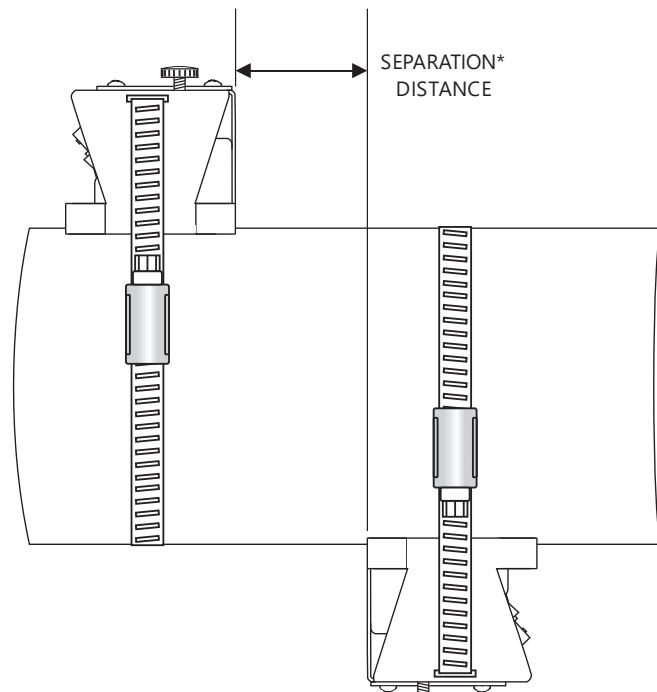
TYPICAL SE16C SENSOR INSTALLATION**2 Cross Separation Distance****1 Cross Separation Distance**

*Shown in 'Set up' menu after sensor, fluid and pipe parameters are entered.

TMK-C1 transducer mounting kit shown. Sensor spacing method is consistent with TMK-C1 or TMK-C2 kits.

Angles on the back of the transducers should be facing away from each other.

SE16A Pipe Preparation and Bracket Mounting

Prepare an area 2" wide by 10" long (50mm x 250mm) for the track mounting bracket by removing loose paint, scale and rust. The objective of site preparation is to eliminate any discontinuity between the sensor and the pipe wall, which would prevent acoustical coupling. A sanding block is included with every meter to facilitate proper pipe preparation.

A Sensor Mounting Kit is supplied with each flow meter. It includes recommended coupling tape and compound, and a stainless-steel mounting bracket with adjustable pipe straps. Use the built-in ruler to easily measure separation distance between transducer faces.

IMPORTANT: Coupling tape is recommended for installations where the sensors cannot easily be accessed in the future to reapply coupling compound, or in installations where the coupling compound may wear away faster than normal (>250 deg F or where submersion is frequent). The coupling tape is subject to greater signal attenuation than the coupling compound, so using coupling compound is recommended when it is possible to periodically reapply the coupling in the future. If you would prefer a maintenance free installation, you can use the coupling tape at initial installation, but may need to switch to coupling compound if you do not have a strong enough signal.

IMPORTANT: The SE16-A transit-time transducers should be installed with the cable connections pointed away from each other, as shown in the drawing below.

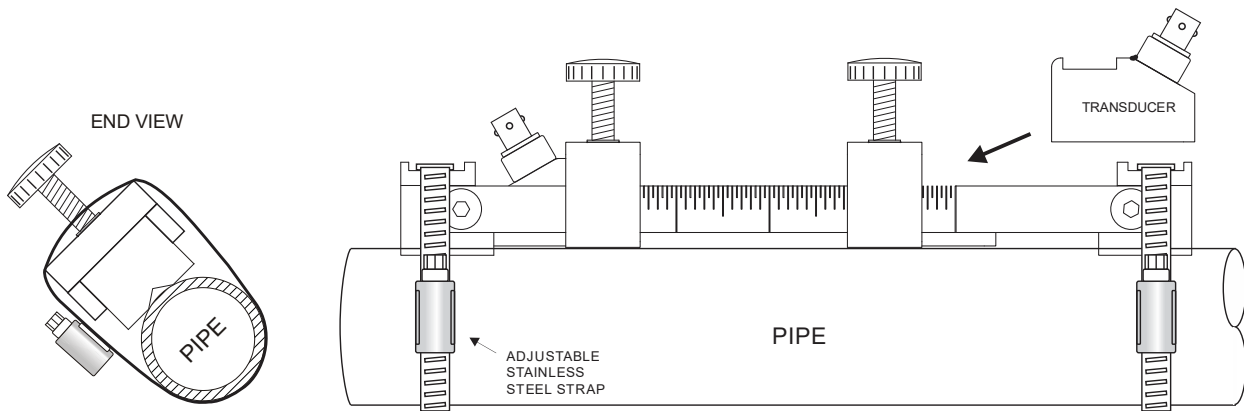

Mount the supplied SE16A Series Transducers on pipes 0.5" / 15 mm OD or larger.

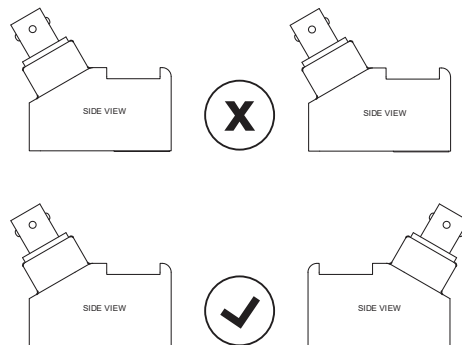

SE16B Pipe Preparation and Bracket Mounting

Prepare an area 2" wide by 4" long (50mm x 100mm) for each sensor bonding by removing loose paint, scale and rust. The objective of site preparation is to eliminate any discontinuity between the sensor and the pipe wall, which would prevent acoustical coupling. A sanding block is included with every meter to facilitate proper pipe preparation.

A Sensor Mounting Kit is supplied with each flow meter. It includes recommended coupling tape and compound, and a stainless steel mounting bracket with adjustable pipe straps. Use the Alignment Bar (included) to align sensor brackets for V and W mode mounting.

IMPORTANT: Coupling tape is recommended for installations where the sensors cannot easily be accessed in the future to reapply coupling compound, or in installations where the coupling compound may wear away faster than normal (>250 deg F or where submersion is frequent). The coupling tape is subject to greater signal attenuation than the coupling compound, so using coupling compound is recommended when it is possible to periodically reapply the coupling in the future. If you would prefer a maintenance free installation, you can use the coupling tape at initial installation, but may need to switch to coupling compound if you do not have a strong enough signal.

IMPORTANT: The SE16-B transit-time transducers have arrows on the top of them. These should face each other at installation.

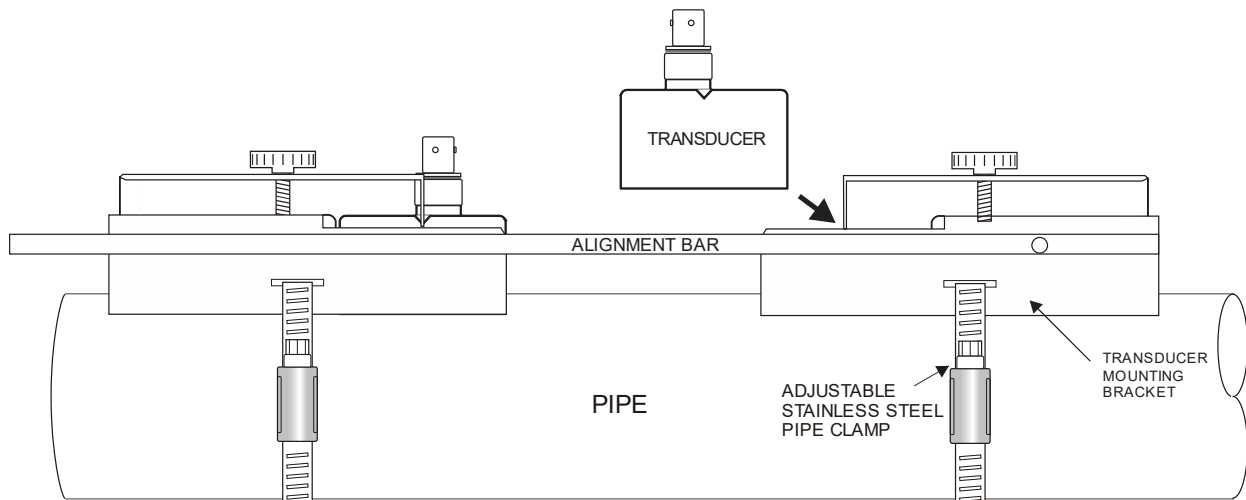

Mount the Mounting Bracket as illustrated on pipes 2" / 50 mm OD or larger. Stainless steel bands are included for mounting on pipes up to 30" / 750 mm OD.

Additional stainless steel bands (provided by customer) may be combined to mount on larger pipes. TMK-B1 Installation Kit shown.



SE16C Pipe Preparation and Bracket Mounting

Prepare an area 2" wide by 4" long (50mm x 100mm) for each sensor bonding by removing loose paint, scale and rust. The objective of site preparation is to eliminate any discontinuity between the sensor and the pipe wall, which would prevent acoustical coupling. A sanding block is included with every meter to facilitate proper pipe preparation.

A Sensor Mounting Kit is supplied with each flow meter. It includes recommended coupling tape and compound, and a stainless-steel mounting bracket with adjustable pipe straps. Use the Alignment Bar (included) to align sensor brackets for V and W mode mounting.

IMPORTANT: Coupling tape is recommended for installations where the sensors cannot easily be accessed in the future to reapply coupling compound, or in installations where the coupling compound may wear away faster than normal (>250 deg F or where submersion is frequent). The coupling tape is subject to greater signal attenuation than the coupling compound, so using coupling compound is recommended when it is possible to periodically reapply the coupling in the future. If you would prefer a maintenance free installation, you can use the coupling tape at initial installation, but may need to switch to coupling compound if you do not have a strong enough signal.

IMPORTANT: The SE16C transit-time transducers do not have arrows on top of them. The cable connection points should be facing away from each other at installation.

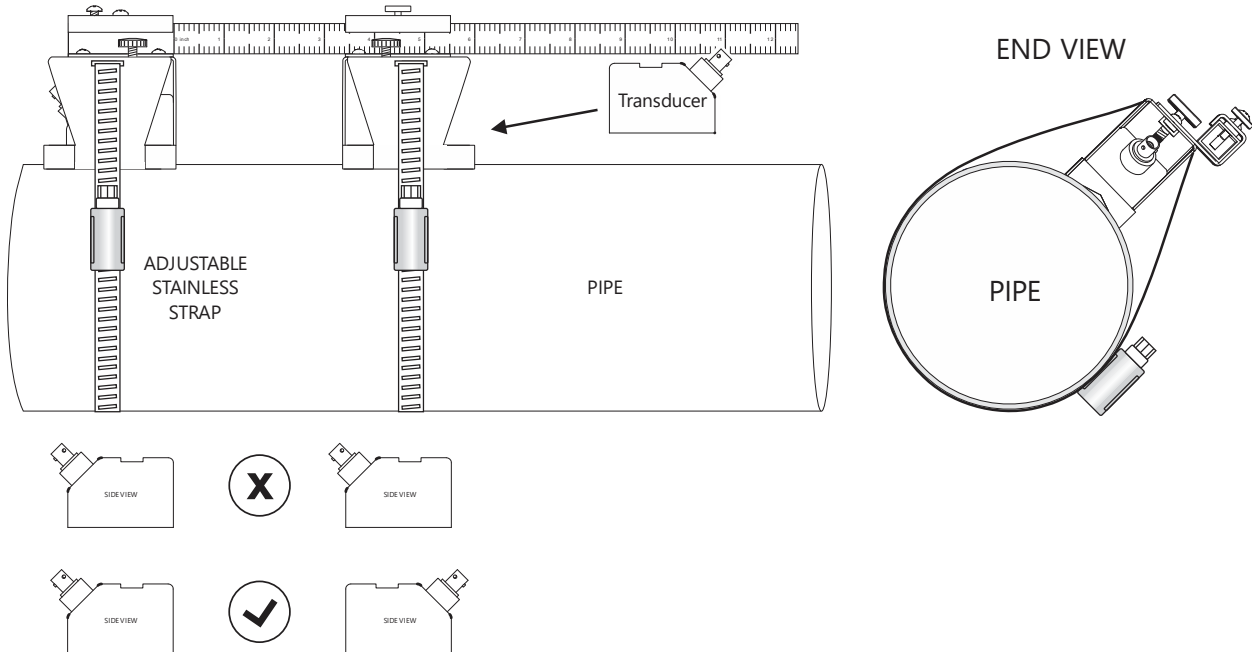

SENSOR COUPLING

For permanent bonding, the following are recommended:

IMPORTANT: Coupling tape is recommended for installations where the sensors cannot easily be accessed in the future to reapply coupling compound, or in installations where the coupling compound may wear away faster than normal (>250 deg F or where submersion is frequent). The coupling tape is subject to greater signal attenuation than the coupling compound, so using coupling compound is recommended when it is possible to periodically reapply the coupling in the future. If you would prefer a maintenance free installation, you can use the coupling tape at initial installation, but may need to switch to coupling compound if you do not have a strong enough signal.

1a) Coupling Tape (supplied) Additional supply: Option CT.

1b) Super Lube® (supplied)

Additional supply: order Option CC-SL30 or your local home improvement store.

For temporary bonding, the following are recommended:

c) Electrocardiograph gel

d) Petroleum gel (Vaseline)

DO NOT USE: Silicon RTV caulking compound (silicon rubber).

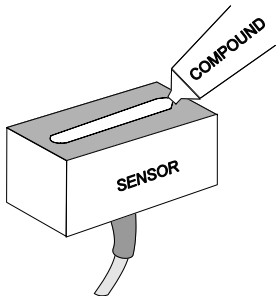

Use the pipe clamp and alignment bar (supplied) as illustrated on previous page. Apply Super Lube® to the colored face of the sensor. A bead, similar to toothpaste on a toothbrush, is ideal. Do not overtighten (crush the sensor).

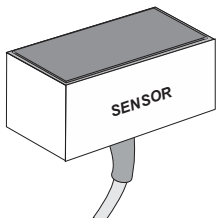

Cut the coupling tape to the length of one transducer. Remove the backing paper from one side of the tape, and apply it to the face of the transducer, as shown to the left. Remove the remaining backing paper from the other side of the coupling tape, and you are ready to insert the transducer into the mounting bracket.

The sensor must be fixed securely to the pipe with coupling material between the sensor face and the pipe. Sensor installation with excessive coupling compound can result in gaps or voids in the coupling and cause errors or loss of signal. Insufficient coupling compound will create similar conditions.

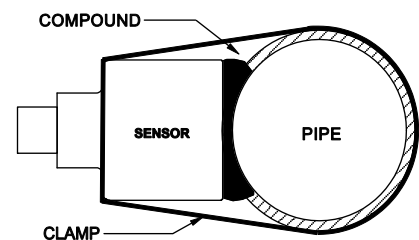

Over time temporary coupling compounds (e.g. Petroleum Gel) may gradually sag away from the sensor resulting in reduced signal strength and finally complete loss of signal. Warm temperatures, moisture and vibration will accelerate this process. Coupling tape and Super Lube® as supplied with the TTFM 6.1 (and available from Pulsar Measurement or home improvement stores) is recommended for permanent installations.

Transducer Installation in Wet Locations (SE16B and SE16A)

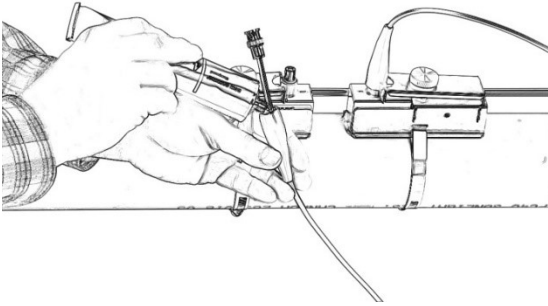

The TTFM 6.1 Transit Time Flowmeter transducers are rated for accidental submersion up to 10 psi (0.75 bar). The flowmeter will continue to operate and measure flow accurately during periods of submergence. Plastic seal jackets on the cables, as well as the BNC connectors, must be filled with coupling compound to provide additional moisture protection for the BNC cable connectors.

Transducer Installation in Wet Locations (SE16C)

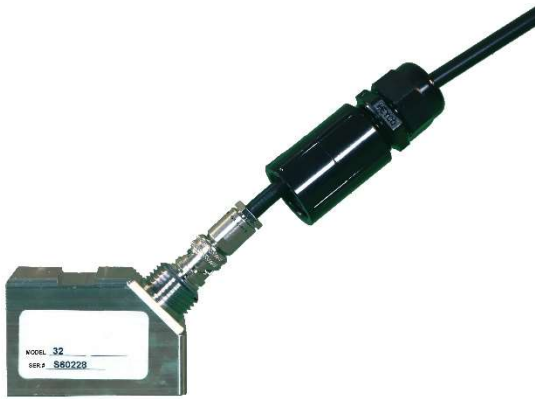

The TTFM 6.1 Transit Time Flowmeter transducers are rated IP67 for accidental submersion up to 1 meter in depth (3.3 feet) for up to 30 minutes. The flowmeter will continue to operate and measure flow accurately during periods of submergence. The provided couplings on the transducer and transducer cable should be tightened to ensure a proper seal. We suggest using Teflon tape on threads connecting the transducer to the coupler.

SENSOR MOUNTING LOCATION

The position of the sensor is one of the most important considerations for accurate flow measurement. The same location guidelines apply to Transit Time as most other flow meter technologies.

VERTICAL OR HORIZONTAL PIPE - Vertical pipe runs are acceptable, and the transducers can be mounted in any orientation around the pipe. Downward flow should be avoided in case the pipe becomes partially filled or aerated. On Horizontal pipes and liquids with high concentrations of gas or solids, the sensors should be mounted on the side (1 to 5 o'clock positions) to avoid concentrations of gas at the top of the pipe, or solids at the bottom.

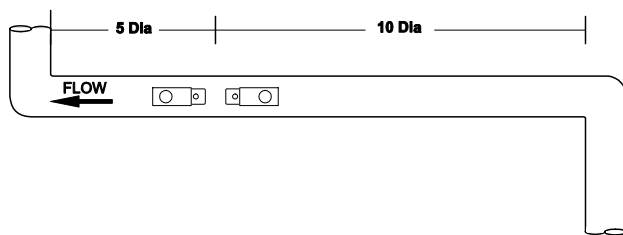
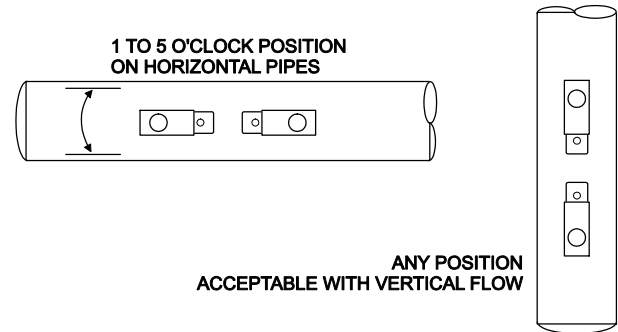

STRAIGHT RUN REQUIREMENTS – For best results, the transducers must be installed on a straight run of pipe, free of bends, tees, valves, transitions, insertion probes and obstructions of any kind. **For most installations, ten straight unobstructed pipe diameters upstream and five diameters downstream of the transducers is the minimum recommended distance for proper operation.** Additional considerations are outlined below.

- Do not, if possible, install the transducers downstream from a throttling valve, a mixing tank, the discharge of a positive displacement pump or any other equipment that could possibly aerate the liquid. The best location will be as free as possible from flow disturbances, vibration, sources of heat, noise, or radiated energy.
- Avoid mounting the transducers on a section of pipe with any external scale. Remove all scale, rust, loose paint, etc., from the location prior to mounting the transducers. A sanding block is included with every meter to facilitate proper pipe preparation.
- Do not mount the transducers on a surface aberration (pipe seam, etc.).
- Do not mount transducers from different ultrasonic flow meters on the same pipe.
- Do not run the transducer triaxial cables in common bundles with cables from other instrumentation. You can run these cables through a common conduit **ONLY** if they originate at the same flow meter.
- Never mount transducers under water.

IMPORTANT NOTE: In some cases, longer straight runs may be necessary where the transducers are placed downstream from devices which cause unusual flow profile disruptions or swirl. For example: modulating valves, or two elbows in close proximity and out of plane.

SEPARATION DISTANCE (Sensor Spacing Distance)

Separation distance is automatically calculated by the TTFM 6.1 based on parameters entered in the Setup menu. Sens Space is a parameter where this distance is given and is located in the Setup menu. Document this value for the following transducer installation procedure.

2 or 4 CROSS INSTALLATION OVERVIEW – SE16A Transducers TMK-A1 Kit

1. Prep the pipe per instructions on page 30 and mind the installation location requirements on page 32. Clean the location where the mounting track is to be installed.
2. Install the stainless steel mounting track on the pipe. Place the tightening brackets near the center, as the transducers are inserted from the outside of them.

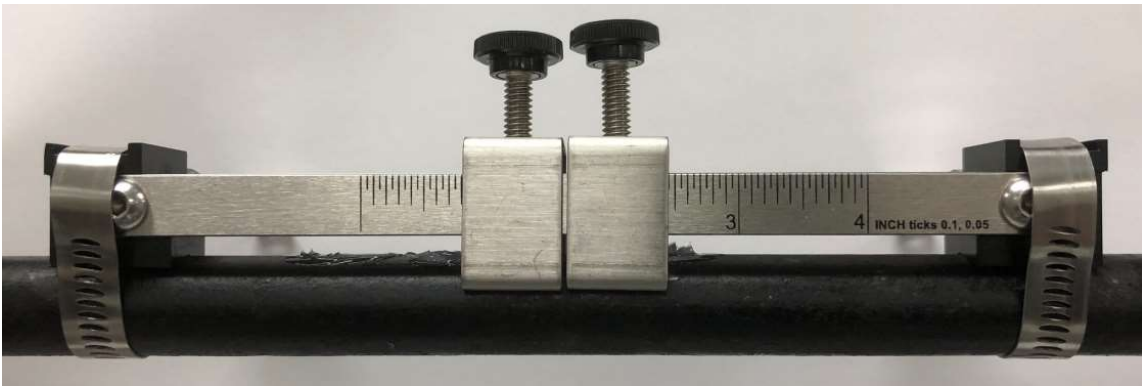

2 or 4 CROSS INSTALLATION OVERVIEW – SE16A Transducers TMK-A1 Kit (Cont.)

3. Apply a small amount of coupling compound on the first transducer and place this transducer in the "reference" position. This is the position where the face of the transducer aligns with the 0 inch or 0 mm mark on the built-in ruler. Tighten this transducer down using the built-in tightening bracket. Do not over-tighten the screw.

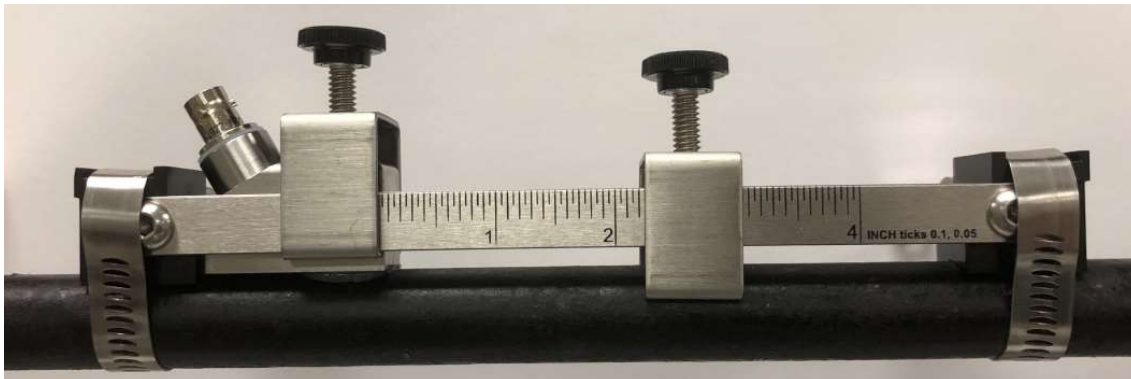
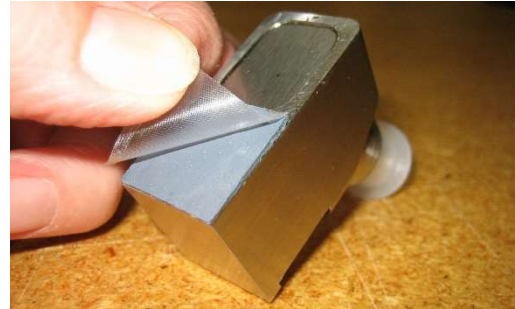

2 or 4 CROSS INSTALLATION OVERVIEW – SE16A Transducers TMK-A1 Kit (Cont.)

4. Apply a small amount of coupling compound on the second transducer and place this transducer at the separation distance provided in the Setup menu of the TTFM. Tighten this transducer down using the built-in tightening bracket. Do not over-tighten the screw.

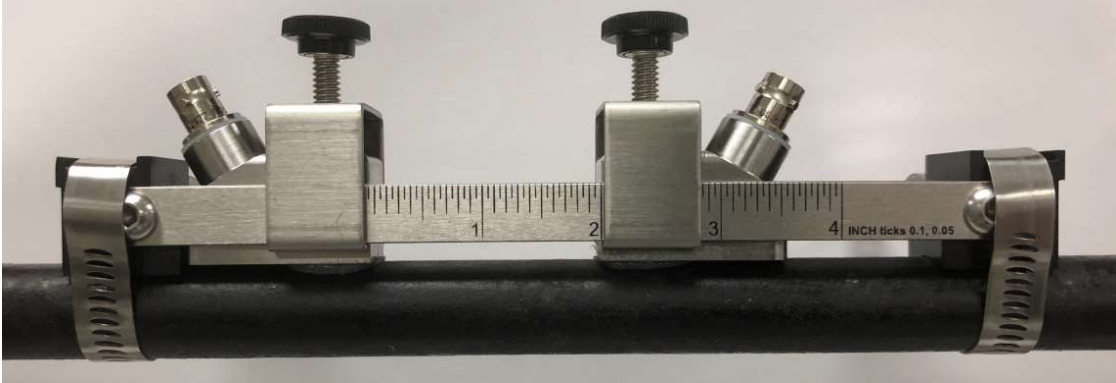

5. Coupling compound only: If you need to make fine adjustments ($\pm 0.1''$) to the spacing at this point, you may do so by loosening the tightening screw slightly, sliding the second transducer, then re-tightening it.

SEPARATION DISTANCE (Sensor Spacing Distance)

Separation distance is automatically calculated by the TTFM 6.1 based on parameters entered in the Setup menu. Sens Space is a parameter where this distance is given, and it is located in the Setup menu. Document this value for the following transducer installation procedure.

2 OR 4 CROSS INSTALLATION OVERVIEW – SE16B TMK-B1 Kit

1. Prep the pipe per instructions on page 29 and mind the installation location requirements on page 32. Clean the location where the sensor is to be mounted on the opposite side of the pipe after we've marked where it will be installed. Picture below shows a very clean ductile iron pipe which did not require much cleaning. The outside paint is very well bonded and did not need to be removed:



2. Install the stainless-steel mounting brackets on the pipe. Position them at approximately the correct separation distance. Exact measurement is not required at this time. Tip: Use a 5/16" nut driver to tighten the hose clamps.

Procedure continued on the next page...

2 OR 4 CROSS INSTALLATION OVERVIEW – SE16B Transducers TMK-B1 Kit (Cont.)

3. Use alignment bar to ensure the brackets are parallel. Completion of steps 2 & 3 is shown below.



4. Mark the position of the permanent bracket on the pipe. This is the bracket that will not be adjusted and will be used as the reference for the separation distance and alignment. It is your choice which bracket is permanent. With a marker, mark the bracket position by placing the mark directly in front of the stainless side-rail.



2 OR 4 CROSS INSTALLATION OVERVIEW – SE16B Transducers TMK-B1 Kit (Cont.)

5. Measure the separation distance from the mark you created in step 4 and create a new mark on the pipe at the separation distance. It may be useful to mark your tape measure (included with every meter) at the separation distance point before marking the pipe. The marked pipe is shown below.

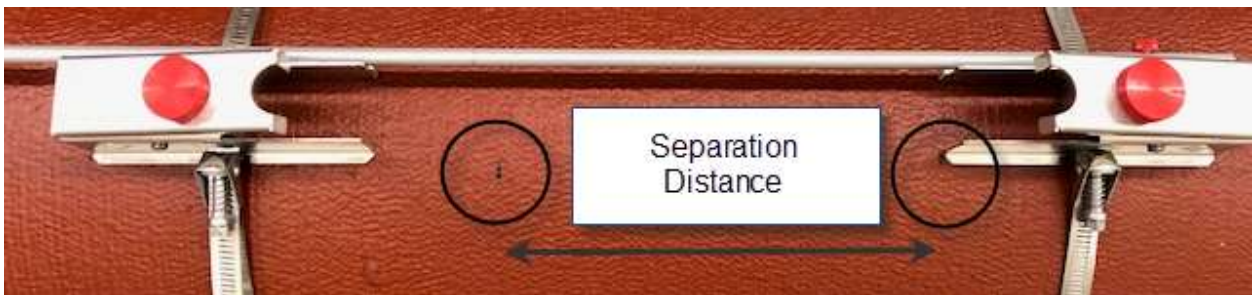

6. Move the non-permanent bracket to position at the mark you created at step 5 and tighten it completely. Apply coupling compound to the transducers and install them in the brackets.

Tips for installing transducers:

- a. Be sure the red knob on the brackets are loosened completely
- b. Put the transducer into the bracket by ensuring the bottom of the transducer and the couplant does not touch the pipe as you slide it in. (Hover)
- c. With the transducer hovering, tighten the red knob on the bracket until tight. The transducer will be level with the surface of the pipe, and no coupling will have moved.

(pictures of proper coupling application and finished installation on the next page)

2 OR 4 CROSS INSTALLATION OVERVIEW – SE16B Transducers TMK-B1 Kit (Cont.)

Proper coupling compound or tape application:

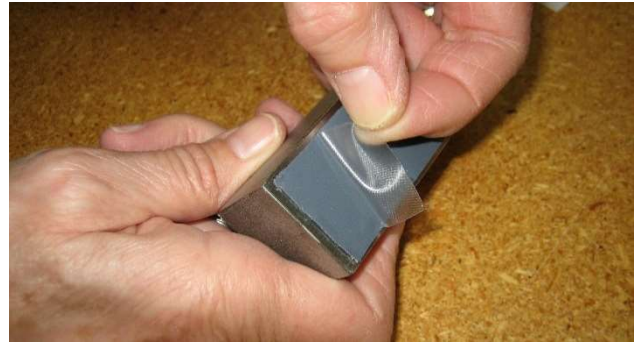

Finished installation, ready for cable connection:



7. Coupling compound only: If you need to make fine adjustments ($\pm 0.25''$) to the spacing at this point, you may do so by loosening the hose clamps slightly and sliding the brackets while the transducers are installed inside them. Tighten hose clamps when done.

SEPARATION DISTANCE (Sensor Spacing Distance)

Separation distance is automatically calculated by the TTFM 6.1 based on parameters entered in the Setup menu. Sens Space is a parameter where this distance is given, and it is located in the Setup menu. Document this value for the following transducer installation procedure.

1 CROSS INSTALLATION OVERVIEW – SE16B Transducers TMK-B1 Kit

To assist with the proper installation of the transducers in a 1 cross installation, we provide a kit with every meter, which consists of the following:

- Sanding block
- Tape measure
- Mylar sleeve
- Duct tape
- Level
- Black Sharpie

Follow along with the 1 cross installation instructions on the following pages for a description of where to use these tools.

1. Prep the pipe per instructions on page 29 and mind the installation location requirements on page 32. Clean the location where the sensor is to be mounted on the opposite side of the pipe after we've marked where it will be installed. The picture below shows a very clean ductile iron pipe which did not require much cleaning.



1 CROSS INSTALLATION OVERVIEW – SE16B Transducers TMK-B1 Kit (Cont.)

2. Install one of the stainless steel mounting brackets on the pipe. This will be the stationary bracket not being rotated to the opposite side of the pipe. For a horizontal pipe, position the bracket at 3 or 9 o'clock. Hold the level up to the top of the bracket to ensure the angle is correct. For vertical pipes, the bracket can be at any orientation about the pipe. Tip: Use a 5/16" nut driver to tighten the hose clamp. Install the second bracket at approximately the distance specified by the Sens Space value in the Setup menu.



3. Use alignment bar to ensure that the brackets are parallel. Completion of steps 2 and 3 is shown below.



1 CROSS INSTALLATION OVERVIEW – SE16B Transducers TMK-B1 Kit (Cont.)

4. Mark the position of the bracket on the pipe. Mark both where the front of the bracket is, as well as the center of the bracket.



5. Measure the separation distance from the marks you created in step 4 and create new marks on the pipe at the separation distance. It may be useful to mark your tape measure at the separation distance before holding it up to and marking the pipe.

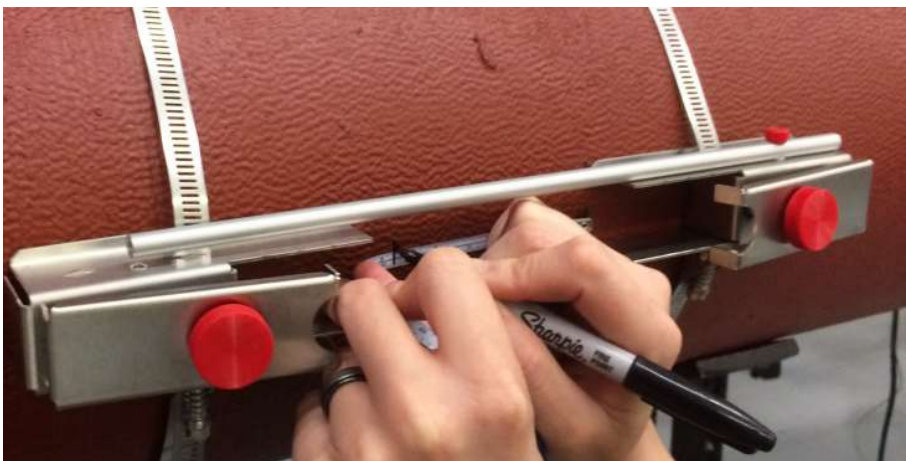

1 CROSS INSTALLATION OVERVIEW – SE16B Transducers TMK-B1 Kit (Cont.)

6. Using the mylar sleeve included with the installation kit, wrap it around the pipe, keep it taut, and with the Sharpie, draw a line anywhere the sleeve overlaps:



7. Lay the mylar sleeve flat, use duct tape to help hold it flat if you need to, and use the tape measure to measure half way between the two marks created when you wrapped the mylar around the pipe:



1 CROSS INSTALLATION OVERVIEW – SE16B Transducers TMK-B1 Kit (Cont.)

8. Position the marked mylar back on the pipe, with the overlap marks on the center line of the transducer bracket that will be rotated to the other side of the pipe. Be sure the mylar is parallel with the face of the transducer. Use duct tape to hold the mylar together and to the pipe. While the mylar is in this position, mark the opposite side of the pipe where the mylar is marked from step 7:

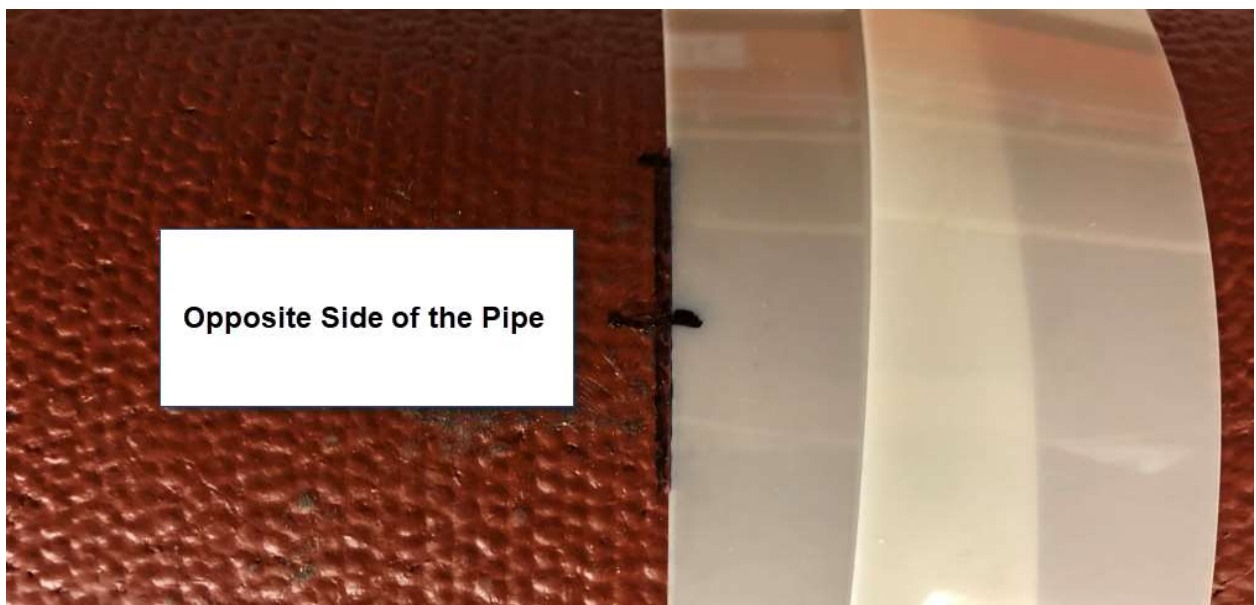
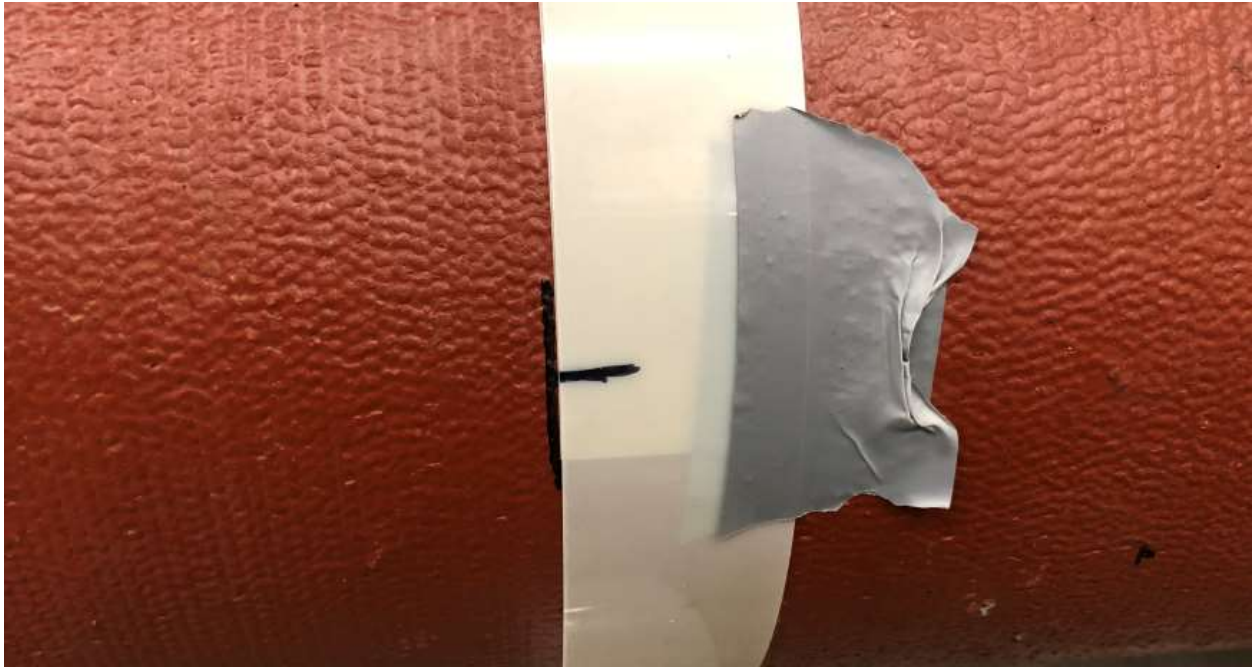

1 CROSS INSTALLATION OVERVIEW – SE16B Transducers TMK-B1 Kit (Cont.)

9. Sand the pipe at this position if it needs to be prepped because of scale or rust. After prepped, move the bracket to this 1 cross mark, and tighten it in place. Apply coupling compound to the transducers and place them in the brackets:

Tips for installing transducers:

- a. Be sure the red knob on the brackets are loosened completely.
- b. Put the transducer into the bracket by ensuring the bottom of the transducer and the couplant does not touch the pipe as you slide it in (hover).
- c. With the transducer hovering, tighten the red knob on the bracket until tight. The transducer will be level with the surface of the pipe, and no couplant will have moved.

Proper coupling compound or tape application:



1 CROSS INSTALLATION OVERVIEW – SE16B Transducers TMK-B1 Kit (Cont.)

Finished installation:

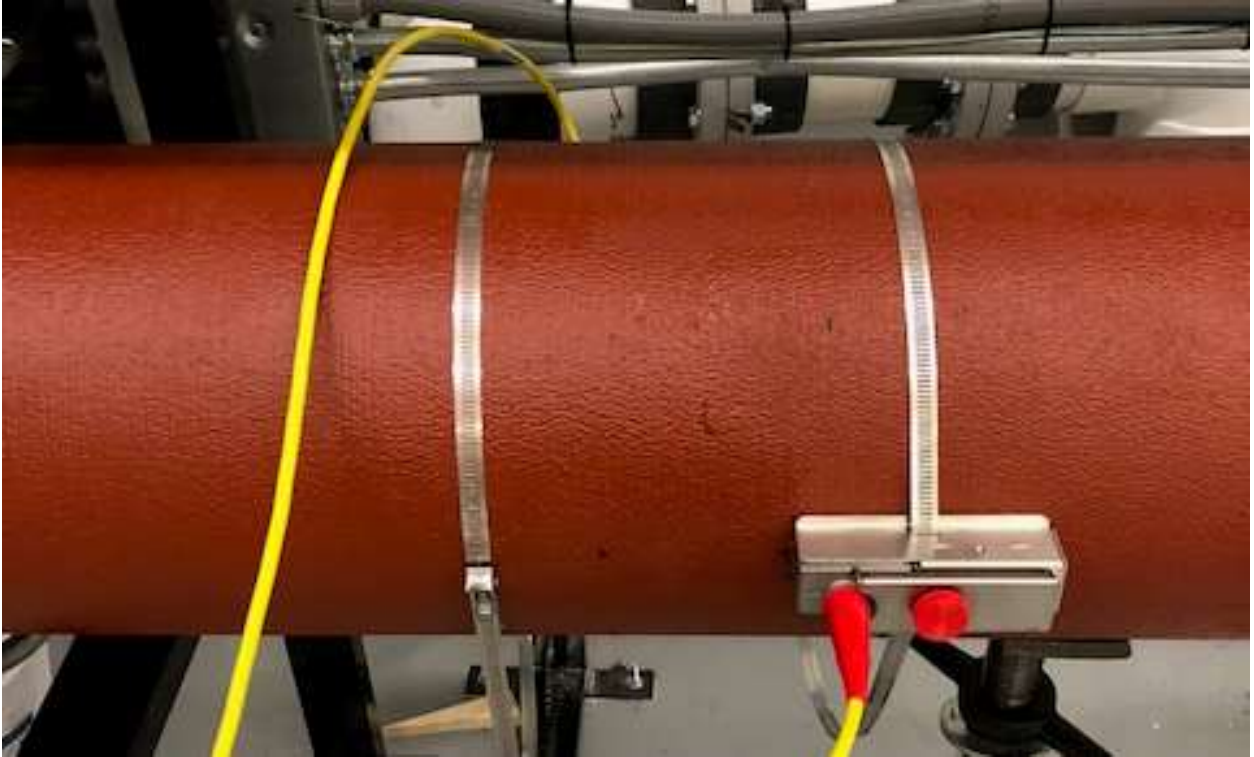

10. Coupling compound only: If you need to make fine adjustments ($\pm 0.25''$) to the spacing at this point, you may do so by loosening the hose clamps slightly and sliding the brackets while the transducers are installed inside them. Tighten the hose clamps when done.

SEPARATION DISTANCE (Sensor Spacing Distance)

Separation distance is automatically calculated by the TTFM 6.1 based on parameters entered in the Setup menu. Sens Space is a parameter where this distance is given and is located in the Setup menu. Document this value for the following transducer installation procedure.

2 OR 4 CROSS INSTALLATION OVERVIEW – SE16B Transducers TMK-B21 or TMK-B22 Kit

1. Prep the pipe per instructions on page 29 and mind the installation location requirements on page 32. Clean the location where the sensor is to be mounted on the opposite side of the pipe after we've marked where it will be installed. Picture below shows a very clean ductile iron pipe which did not require much cleaning. The outside paint is very well bonded and did not need to be removed:



2 OR 4 CROSS INSTALLATION OVERVIEW - SE16B Transducers TMK-B21 or TMK-B22 Kit (Cont.)

2. Install the spacer bar onto the right bracket as shown below:

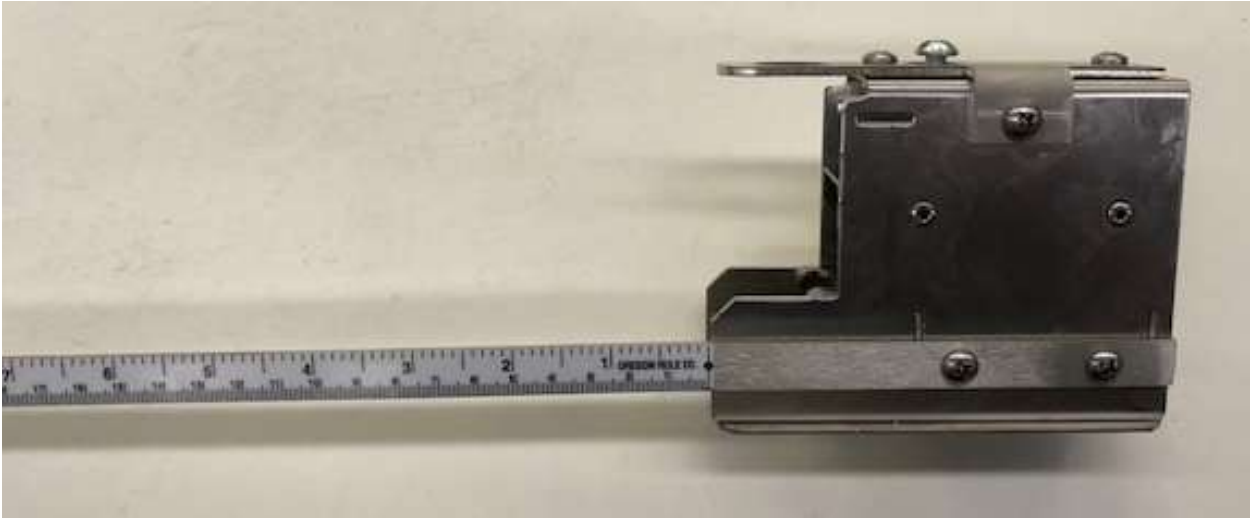

3. Insert the spacer bar into the left bracket and position the bracket at the separation distance referenced earlier. Tighten the spacer bar clamp at this position:

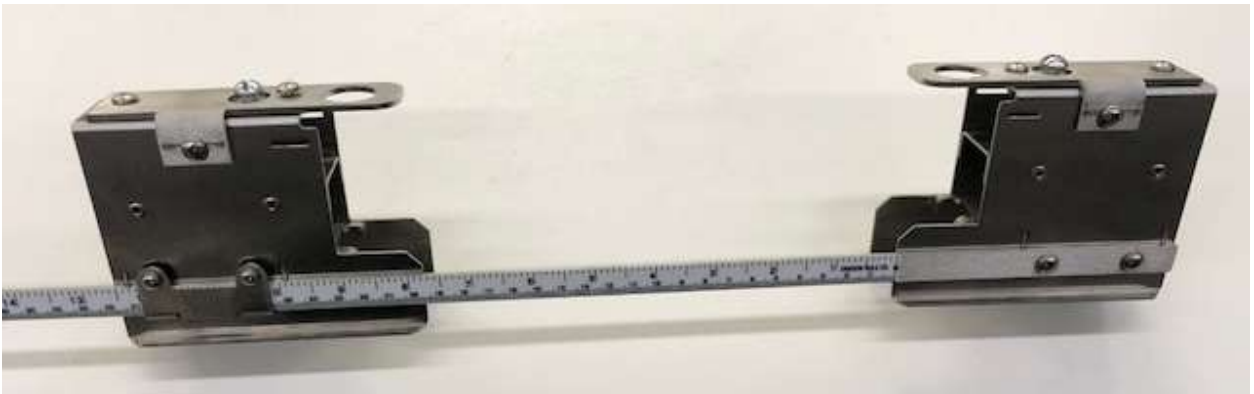

2 OR 4 CROSS INSTALLATION OVERVIEW - SE16B Transducers TMK-B21 or TMK-B22 Kit (Cont.)

4. Place the bracket assembly on the pipe, tighten it in place with the two hose clamps:



5. Apply coupling compound to the transducers and install them in the brackets.

Tips for installing transducers:

- a. Be sure the tightening Phillips screw on the top of the bracket is loosened completely.
- b. Put the transducer into the bracket by ensuring the bottom of the transducer and the couplant does not touch the pipe as you slide it in. (Hover)
- c. Tighten the Phillips screws on the bracket until tight. The transducer will be level with the surface of the pipe, and no coupling will have moved.

(pictures of proper coupling application and finished installation on the next page)

2 OR 4 CROSS INSTALLATION OVERVIEW - SE16B Transducers TMK-B21 or TMK-B22 Kit (Cont.)

Proper coupling compound or tape application:



Finished installation, ready for cable and conduit connection:



6. Coupling compound only: If you need to make fine adjustments ($\pm 0.25''$) to the spacing at this point, you may do so by loosening the hose clamps slightly and sliding the brackets while the transducers are installed inside them. Tighten hose clamps when done.

SEPARATION DISTANCE (Sensor Spacing Distance)

Separation distance is automatically calculated by the TTFM 6.1 based on parameters entered in the Setup menu. Sens Space is a parameter where this distance is given, and it is located in the Setup menu. Document this value for the following transducer installation procedure.

1 CROSS INSTALLATION OVERVIEW – SE16B Transducers TMK-B21 or TMK-B22 Kit

To assist with the proper installation of the transducers in a 1 cross installation, we provide a kit with every meter, which consists of the following:

- Sanding block
- Tape measure
- Mylar sleeve
- Duct tape
- Level
- Black Sharpie

Follow along with the 1 cross installation instructions on the following pages for a description of where to use these tools.

1. Prep the pipe per instructions on page 29 and mind the installation location requirements on page 32. Clean the location where the sensor is to be mounted on the opposite side of the pipe after we've marked where it will be installed. The picture below shows a very clean ductile iron pipe which did not require much cleaning.



1 CROSS INSTALLATION OVERVIEW – SE16B Transducers TMK-B21 or TMK-B22 Kit (Cont.)

2. Install the spacer bar onto the right bracket as shown below:



3. Insert the spacer bar into the left bracket and position the bracket at the separation distance referenced earlier. Tighten the spacer bar clamp at this position:



1 CROSS INSTALLATION OVERVIEW – SE16B Transducers TMK-B21 or TMK-B22 Kit (Cont.)

4. Place the bracket assembly on the pipe, tighten it in place with the two hose clamps. For a horizontal pipe, position the bracket at 3 or 9 o'clock. Hold the level up to the top of the bracket to ensure the angle is correct. For vertical pipes, the bracket can be at any orientation about the pipe. Tip: Use a 5/16" nut driver to tighten the hose clamp.



5. Mark the position of the center line of the bracket which is to be moved to the opposite side of the pipe. It is up to you to determine which bracket is easier to move from the current position:

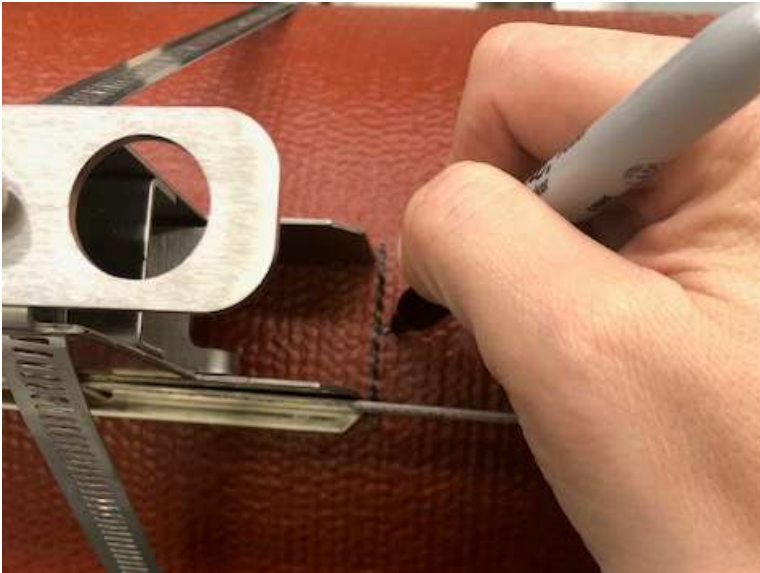

1 CROSS INSTALLATION OVERVIEW – SE16B Transducers TMK-B21 or TMK-B22 Kit (Cont.)

- Using the mylar sleeve included with the installation kit, wrap it around the pipe, keep it taut, and with the Sharpie, draw a line anywhere the sleeve overlaps:



- Lay the mylar sleeve flat, and use the tape measure to measure half way between the two marks created when you wrapped the mylar around the pipe:



1 CROSS INSTALLATION OVERVIEW – SE16B Transducers TMK-B21 or TMK-B22 Kit (Cont.)

8. Position the marked mylar back on the pipe, with the overlap marks on the center line of the transducer bracket that will be rotated to the other side of the pipe. Be sure the mylar is parallel with the face of the transducer. Use duct tape to hold the mylar together and to the pipe. While the mylar is in this position, mark the opposite side of the pipe where the mylar is marked from step 7:

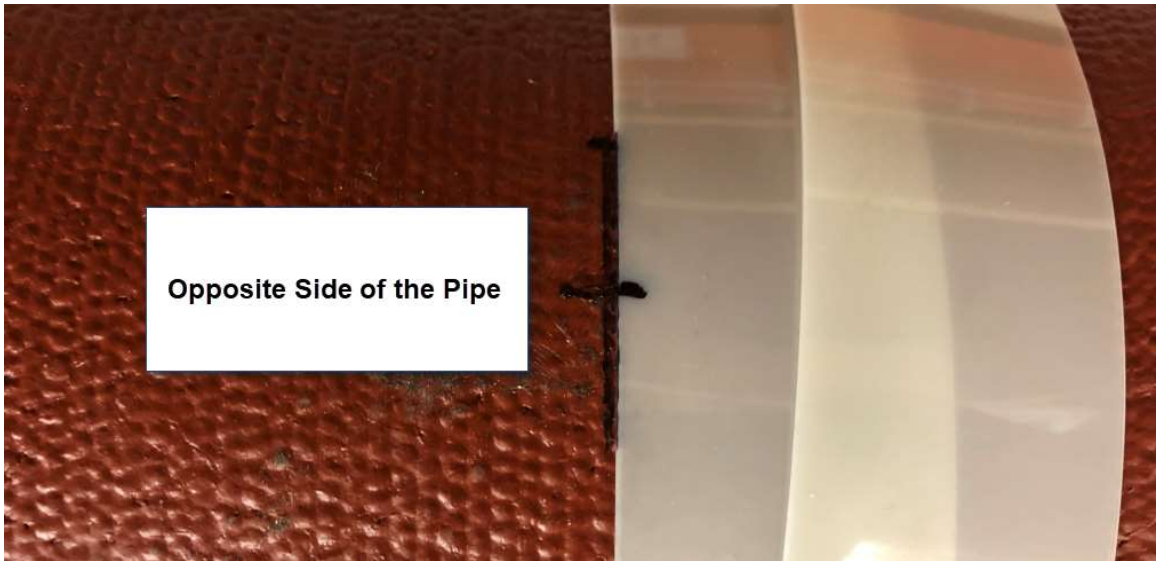

1 CROSS INSTALLATION OVERVIEW – SE16B Transducers TMK-B21 or TMK-B22 Kit (Cont.)

9. Sand the pipe at this position if it needs to be prepped because of scale or rust. After prepped, move the bracket to this 1 cross mark, and tighten it in place. Apply coupling compound to the transducers and place them in the brackets:

View from front of pipe:



View from back of pipe:

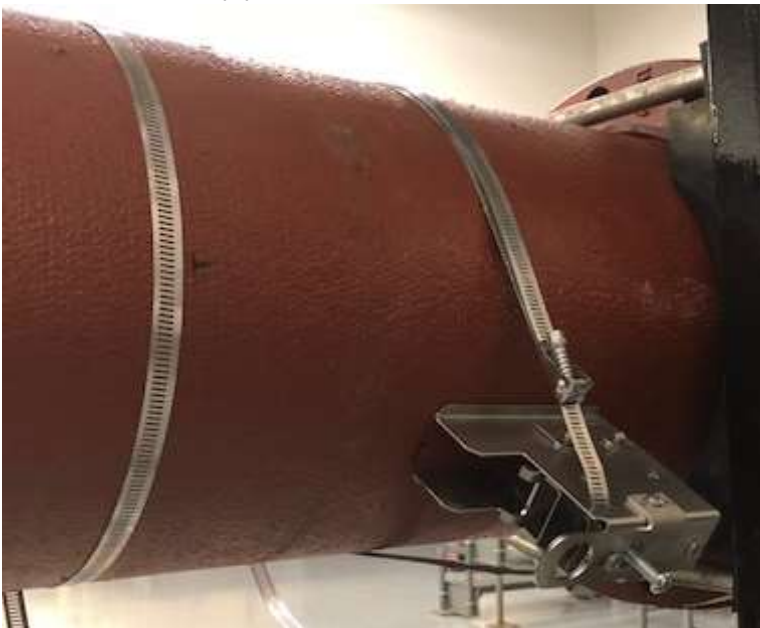

Tips for installing transducers:

- a. Be sure the tightening screws on the brackets are loosened completely.
- b. Put the transducer into the bracket by ensuring the bottom of the transducer and the couplant does not touch the pipe as you slide it in (hover).

1 CROSS INSTALLATION OVERVIEW – SE16B Transducers TMK-B21 or TMK-B22 Kit (Cont.)

- c. With the transducer hovering, tighten the screws on the bracket until tight. The transducer will be level with the surface of the pipe, and no coupling will have moved from inserting the transducer in the bracket.

Proper coupling compound or tape application:



Finished installation:

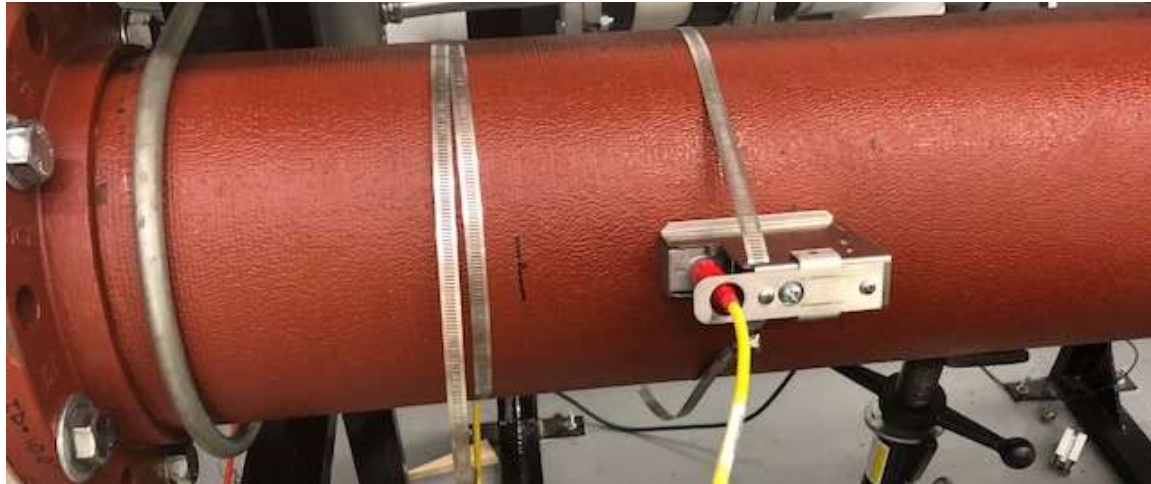

- 10. Coupling compound only: If you need to make fine adjustments ($\pm 0.25''$) to the spacing at this point, you may do so by loosening the pipe clamps slightly and sliding the brackets while the transducers are installed inside them. Tighten the pipe clamps when done.

SEPARATION DISTANCE (Sensor Spacing Distance)

Separation distance is automatically calculated by the TTFM 6.1 based on parameters entered in the Setup menu. Sens Space is a parameter where this distance is given, and it is located in the Setup menu. Document this value for the following transducer installation procedure.

2 CROSS INSTALLATION OVERVIEW – SE16C Transducers TMK-C1 or TMK-C2 Kit

1. Prep the pipe per instructions on page 32 and mind the installation location requirements on page 35. Clean the location where the sensor is to be mounted on the opposite side of the pipe after we've marked where it will be installed. Picture below shows a very clean carbon steel pipe which did not require much cleaning:



2. Install the stainless steel mounting brackets on the pipe. Position them at approximately the correct separation distance. Exact measurement is not required at this time. Tip: Use a 5/16" nut driver to tighten the pipe clamps.

Procedure continued on the next page...

3. Use the built-in alignment bar with ruler to set the bracket spacing to the separation distance provided in the Setup menu. One transducer is placed at the 0"/0mm reference position, and the other at the separation distance from the Setup menu. For TMK-C2 kits, use the alignment bar extension to reach further separation distances.



4. Tighten the assembly in place with the two hose clamps
5. Apply coupling compound or tape to the transducers, insert them into the brackets, and tighten them in place with hand screws.

Tips for installing transducers:

- a. Be sure the tightening screw on the top of the bracket is loosened completely before attempting to insert the transducers.
- b. Put the transducer into the bracket by ensuring the bottom of the transducer and the couplant does not touch the pipe as you slide it in. (Hover as you insert it)
- c. Tighten the screws on the bracket until tight. The transducer will be level with the surface of the pipe.



6. Coupling compound only: If you need to make fine adjustments ($\pm 0.25''$) to the spacing at this point, you may do so by loosening the hose clamps slightly and sliding the brackets while the transducers are installed inside them. Tighten hose clamps when done.

SEPARATION DISTANCE (Sensor Spacing Distance)

Separation distance is automatically calculated by the TTFM 6.1 based on parameters entered in the Setup menu. Sens Space is a parameter where this distance is given, and it is located in the Setup menu. Document this value for the following transducer installation procedure.

1 CROSS INSTALLATION OVERVIEW – SE16C Transducers TMK-C1 or TMK-C2 Kit

To assist with the proper installation of the transducers in a 1 cross installation, we provide a kit with every meter, which consists of the following:

- Sanding block
- Tape measure
- Mylar sleeve
- Duct tape
- Level
- Black Sharpie

Follow along with the 1 cross installation instructions on the following pages for a description of where to use these tools

1. Prep the pipe per instructions on page 32 and mind the installation location requirements on page 35. Clean the location where the sensor is to be mounted on the opposite side of the pipe after we've marked where it will be installed. Picture below shows a very clean carbon steel pipe which did not require much cleaning:



2. Install the stainless steel mounting brackets on the pipe. Position them at approximately the correct separation distance. Exact measurement is not required at this time. Tip: Use a 5/16" nut driver to tighten the hose clamps.
3. Use the built-in alignment bar with ruler to set the bracket spacing to the separation distance provided in the Setup menu. One transducer is placed at the 0"/0mm reference position, and the other at the separation distance from the Setup menu. For TMK-C2 kits, use the alignment bar extension to reach further separation distances.



4. Tighten the assembly in place with the two hose clamps. For a horizontal pipe, position the bracket at 3 or 9 o'clock. Hold the level up to the top of the bracket to ensure the angle is correct. For vertical pipes, the bracket can be at any orientation about the pipe. Use a 5/16" nut driver to tighten the hose clamps:



5. Mark the position of the center line of the bracket which is to be moved to the opposite side of the pipe. It is up to you to determine which bracket is easier to move from the current position:



- Using the mylar sleeve included with the installation kit, wrap it around the pipe, keep it taut, and with the Sharpie, draw a line anywhere the sleeve overlaps:



- Lay the mylar sleeve flat, and use the tape measure to measure half way between the two marks created when you wrapped the mylar around the pipe:



8. Position the marked mylar back on the pipe, with the overlap marks on the center line of the transducer bracket that will be rotated to the other side of the pipe. Be sure the mylar is parallel with the face of the transducer. Use duct tape to hold the mylar together and to the pipe. While the mylar is in this position, mark the opposite side of the pipe where the mylar is marked from step 7:



9. Sand the pipe at this position if it needs to be prepped because of scale or rust. After prepped, move the bracket to this 1 cross mark, and tighten it in place. Apply coupling compound to the transducers and place them in the brackets.

Tips for installing transducers:

- a. Be sure the tightening screw on the top of the bracket is loosened completely before attempting to insert the transducers.
- b. Put the transducer into the bracket by ensuring the bottom of the transducer and the couplant does not touch the pipe as you slide it in. (Hover as you insert it)
- c. Tighten the screws on the bracket until tight. The transducer will be level with the surface of the pipe.



10. Coupling compound only: If you need to make fine adjustments ($\pm 0.25''$) to the spacing at this point, you may do so by loosening the hose clamps slightly, and sliding the brackets while the transducers are installed inside them. Tighten hose clamps when done.

SENSOR MOUNTING/COUPLING RECOMMENDATIONS

BAD

Avoid air traveling at the top of a horizontal pipe.

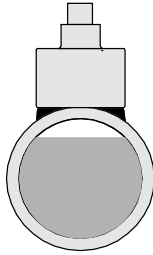

Avoid debris traveling at the bottom of a horizontal pipe.

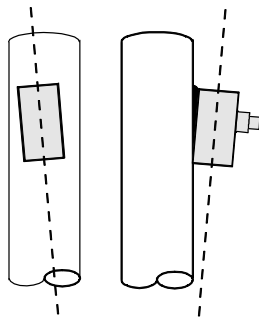
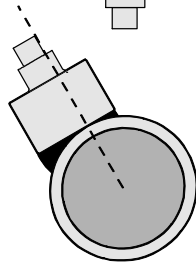
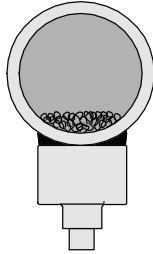

GOOD

Installing between 1 and 5 o'clock, and 7 and 11 o'clock on horizontal pipes is acceptable.

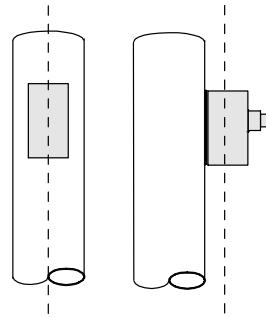
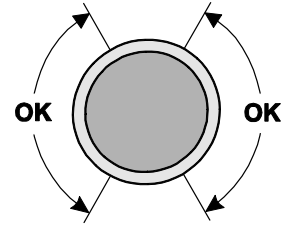
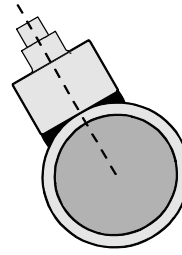
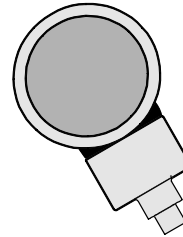
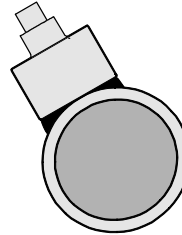

ENCLOSURE INSTALLATION

Locate the enclosure within 25 ft (7.6 m) of the sensors (up to 100 ft - 30 m optional). The enclosure can be wall mounted with the four mounting screws (included) or panel mounted with Option PM Panel Mount kit from Pulsar Measurement.

Avoid mounting the enclosure in direct sunlight to protect the electronics from damage due to overheating and condensate. In high humidity atmospheres, or where temperatures fall below freezing, Option TH Enclosure Heater and Thermostat is recommended. **IMPORTANT:** Seal conduit entries to prevent moisture from entering enclosure.

NEMA4X (IP66) WITH CLEAR COVER

1. Open hinged enclosure cover.
2. Insert #12 screws (supplied) through the four enclosure mounting holes to secure the enclosure to the wall or mounting stand.

Additional conduit holes can be cut in the bottom of the enclosure when required. Use a hole saw or Greenlee-type hole cutter to cut the required holes.

IMPORTANT: DO NOT make conduit/wiring entries into the top or sides of the enclosure.

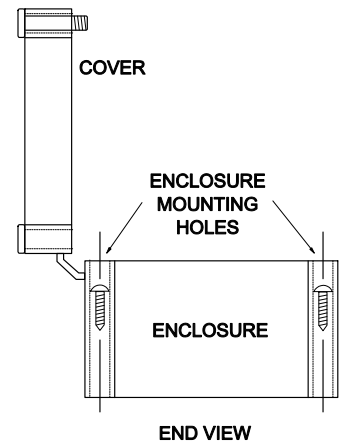

Note: This non-metallic enclosure does not automatically provide grounding between conduit connections. Grounding must be provided as part of the installation. Ground in accordance with the requirements of the National Electrical Code. System grounding is provided by connecting grounding wires from all conduit entries to the steel mounting plate or another point which provides continuity.

CLEANING

Cleaning is not required as a part of normal maintenance.

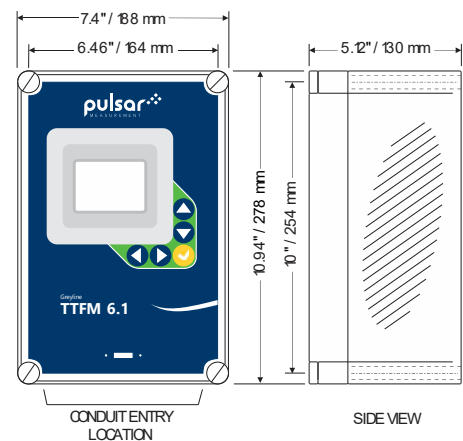

FIELD TROUBLESHOOTING

POSSIBLE CAUSES:

CORRECTIVE ACTION:

METER READING WHEN THERE IS NO FLOW?

Erratic measurement (set damping to 0% to check) due to electrical noise or poor signal quality.

- Set Calibration/ Damping to 0% with zero flow use Setup / Tare function.
- Ensure all Flowmeter wiring is in METAL conduit and sensor shield is properly connected to Ground.
- Ensure correct power input Ground connection (<1 ohm resistance).
- Ensure 4-20mA Shield connected to Instrument Ground stud.
- Adjust Calibration / Min Flow setting.
- Contact Pulsar Measurement for further assistance.

Variable Speed Drive interference

- Follow Drive manufacturers wiring and Grounding instructions
- Relocate Flowmeter electronics, Sensor and wiring away from VSD

METER READING LOWER THAN EXPECTED?

Calibration Error

- Review calibration menu. Pipe dimensions and fluid selection/fluid velocity.

Lower flow rate than expected

- Investigate pump/valves. Compare velocity with alternate instrument.

Erratic measurement (set damping to 0% to check) due to electrical noise or poor signal quality.

- Ensure all Flowmeter wiring is in METAL conduit and sensor shield is properly grounded.
- Ensure correct power input Ground connection (<1 ohm resistance).
- Ensure 4-20mA Shield connected to Instrument Ground stud.
- Contact Pulsar Measurement for further assistance.

NO ECHO INDICATION Icon: No Echo

Improper Installation

- Check Setup menu to ensure pipe material, size, thickness, liner type, thickness, fluid type, and fluid temperature and configured properly. Check transducer mounting method and spacing matches Setup menu values.

Sensors not mounted to Pipe or mounted improperly

- Apply coupling compound and mount sensors to pipe with proper sensor spacing.

Empty pipe or partially filled

- Pipe must be fluid filled and acoustically transparent in order to obtain echoes.

Coupling compound washed out, or sensor loose on pipe.

- Remount sensor
- Use Super Lube® Silicone Compound

SENSOR CONNECTIONS

OPEN/SHORT SENSOR ICON	<ul style="list-style-type: none"> • No sensors attached • Short in transducer, or in triax transducer cable. Follow Sensor Connections steps
Sensor Connections	<ul style="list-style-type: none"> • Check sensor connections at TTFM and at sensor junction box. • Note: Refer to Sensor Cable Resistance Test to test final connections.

METER READING HIGHER THAN EXPECTED?

Calibration Error	<ul style="list-style-type: none"> • Review calibration menu. Pipe dimensions and fluid selection/fluid velocity.
Higher flow rate than expected	<ul style="list-style-type: none"> • Investigate pump/valves. Compare velocity with alternate instrument.
Erratic measurement (set damping to 0% to check) due to electrical noise or poor signal quality.	<ul style="list-style-type: none"> • Ensure all Flowmeter wiring is in METAL conduit and sensor shield is properly grounded. • Ensure correct power input Ground connection (<1 ohm resistance). • Ensure 4-20mA Shield connected to Instrument Ground stud. • Contact Pulsar Measurement for further assistance.
High viscosity fluid	<ul style="list-style-type: none"> • Laminar flow profile due to high viscosity fluid requires an adjustment to Cal Const.

SENSOR CABLE & TRANSDUCER RESISTANCE TEST

Unplug the green sensor terminal from the Transit Time board with the sensor wires still connected and the BNC end of the cable is connected to the transducer. With a multimeter, perform resistance checks for each set of wires. One single loose terminal may cause false readings.

Test across shield and core of each wire: TDR1 and TDR2. Resistance should be around 10K ohms for any cable length. High readings indicate an open circuit and low readings indicate a short or partial short in the sensor cable connections or transducer.

Note: The TTFM 6.1 will automatically detect connectivity to the sensors. Confirm that TTFM 6.1 indicates "Sensor Good" in the messages menu if your resistance measured is approximately 10K Ohms.



COMMON QUESTIONS AND ANSWERS

The pipe vibrates. Will it affect the flow meter?

Common vibration frequencies are far lower than the sonic frequencies used by the flow meter, and will not normally affect accuracy or performance. However, applications where very weak Transit Time signal is present (when sensitivity is adjusted to maximum and signal strength is low), accuracy may be affected by pipe vibration, or the flow meter may show readings under no-flow conditions. Attempt to relocate the sensor on a pipe section where vibration is reduced, or arrange pipe mounting brackets to reduce vibration at the sensor mounting location.

The flow meter must be installed in a high noise environment. Will this affect operation?

Our flow meters are designed to discriminate between environmental noise and the Transit Time signal. High noise environments may affect the flow meter's performance where low signal strength and/or low flow velocities are being measured. Relocate the sensor in a quieter environment if possible.

Will pipe corrosion affect accuracy of the flow meter?

Yes. Rust, loose paint etc. must be removed from the outside of the pipe to provide a clean mounting position when installing a Transit Time sensor. Severe corrosion/oxidation on the inside of the pipe may prevent the Transit Time signal from penetrating into the flow. If the pipe cannot be cleaned, a spool piece (PVC recommended) should be installed for sensor mounting.

What effect do pipe liners have on the flow meter?

The air gap between loose insertion liners and the pipe wall prevent the Transit Time signal from entering the flow. Better results can be expected with bonded liners such as cement, epoxy or tar, however an on site test is recommended to determine if the application is suitable for a Transit Time flow meter.

Why is Transit Time recommended for clean liquids?

The Transit Time sensor transmits sound across the flow stream in order to measure the time it takes to arrive at the other sensor, and therefore requires a fluid medium that is relatively transparent to the acoustic signal. The Transit Time system will not function when there is high volume of solids or aeration. As a guideline, Transit Time flow meters are recommended for clean liquids with solids or bubbles content less than 2% by volume.

Can the sensor be submerged in water?

Yes, for short periods of time or by accident, but it is not recommended for continuous operation. The sensor is constructed to withstand submersion to 10 psi (0.7 Bar) without damage provided the protective rubber boot is filled with Super Lube®.

COMMON QUESTIONS AND ANSWERS (cont.)

What is the purpose of the Signal Strength Display?

The primary function of the signal strength display is to assist as a feedback when mounting sensors. Signal Strength can also be a useful diagnostics tool when troubleshooting problems with an installation. A signal strength less than 100% may indicate a problem with the installation or other issues such as a mis-programmed pipe size, pipe material, fluid type or temperature, or wrong transducer spacing. A signal strength less than 100% may also simply indicate a lot of aeration, or deteriorated pipe. Consideration should be made to use a 1 cross installation in such a case.

Can I change the length of the sensor cable?

Yes. The Transit Time design allow cable lengths up to 100 ft (30 m) or extension up to 250 ft with extra cable and JB2X optional junction box. Replacement cable of different length may be installed in rigid or flexible conduit for mechanical protection. Use only our shielded triaxial cable.

Does the TTFM 6.1 require periodic recalibration?

TTFM 6.1 calibration does not drift over time. The solid state sensor has no moving parts to wear and affect calibration. All timing/counting circuits use crystal-controlled frequency references to eliminate any drift in the processing circuitry.

ISO 9000 or similar quality management systems may require periodic and verifiable recalibration of flow meters. TTFM 6.1 Flow Meters may be returned to Pulsar Measurement for factory calibration and issue of a new NIST traceable certificate. Refer to the 'Product Return Procedure' section of this manual for return instructions.

APPLICATIONS HOTLINE

For applications assistance, advice or information on any Pulsar Measurement Instrument contact your Sales Representative, write to Pulsar Measurement or phone the Applications Hotline below:

COUNTRY	TEL	FAX	E-MAIL	ADDRESS
United States	315-788-9500	315-764-0419	northamerica@pulsarmeasurement.com	11451 Belcher Road South Largo, FL 33773
Canada	613-938-8956	613-938-4857	northamerica@pulsarmeasurement.com	16456 Sixsmith Drive Long Sault, Ont. K0C 1P0
UK	+44 (0) 1684 891371	+44 (0) 1684 575985	europa@pulsarmeasurement.com	Cardinal Building Enigma Commercial Centre Sandy's Road, Malvern WR14 1JJ
Asia	N/A	N/A	asiapacific@pulsarmeasurement.com	34-1A, Jalan 10A/KU5 Taman Aman Perdana 41050 Klang, Selangor, Malaysia
Oceania	+61 428 692 274	N/A	oceania@pulsarmeasurement.com	N/A

PRODUCT RETURN PROCEDURE

Instruments may be returned to Pulsar Measurement for service or warranty repair.

1 Obtain an RMA Number from Pulsar Measurement -

Before shipping a product to the factory please contact Pulsar Measurement by telephone, fax or email to obtain an RMA number (Returned Merchandise Authorization). This ensures fast service and correct billing or credit.

When you contact Pulsar Measurement please have the following information available:

1. Model number / Software Version
2. Serial number
3. Date of Purchase
4. Reason for return (description of fault or modification required)
5. Your name, company name, address and phone number

2 Clean the Sensor/Product -

Important: unclean products will not be serviced and will be returned to the sender at their expense.

1. Rinse sensor and cable to remove debris.
2. If sensor has been exposed to sewage, immerse both sensor and cable in a solution of 1 part household bleach (Javex, Clorox etc.) to 20 parts water for 5 minutes. Important: do not immerse open end of sensor cable.
3. Dry with paper towels and pack sensor and cable in a sealed plastic bag.
4. Wipe the outside of the enclosure to remove dirt or deposits.
5. Return to Pulsar Measurement for service.

LIMITED WARRANTY

Pulsar Measurement warrants, to the original purchaser, its products to be free from defects in material and workmanship for a period of two years from date of invoice. Pulsar Measurement will replace or repair, free of charge, any Pulsar product if it has been proven to be defective within the warranty period. This warranty does not cover any expenses incurred in the removal and re-installation of the product.

If a product manufactured by Pulsar should prove defective within the first year, return it freight prepaid to Pulsar Measurement along with a copy of your invoice.

This warranty does not cover damages due to improper installation or handling, acts of nature, or unauthorized service. Modifications to or tampering with any part shall void this warranty. This warranty does not cover any equipment used in connection with the product or consequential damages due to a defect in the product.

All implied warranties are limited to the duration of this warranty. This is the complete warranty by Pulsar Measurement and no other warranty is valid against Pulsar Measurement. Some states do not allow limitations on how long an implied warranty lasts or limitation of incidental or consequential damages, so the above limitations or exclusions may not apply to you.

This warranty gives you specific legal rights, and you may also have other rights which vary from state to state.

Pulsar Measurement

ENCLOSURE HEATER AND THERMOSTAT - Option TH

Instruments can be factory-equipped with an Enclosure Heater and Thermostat or the module can be customer-installed. The Thermostat is factory set to turn ON at 40°F (4.5°C) and OFF at 60°F (15.5°C). Power consumption is 15 Watts.

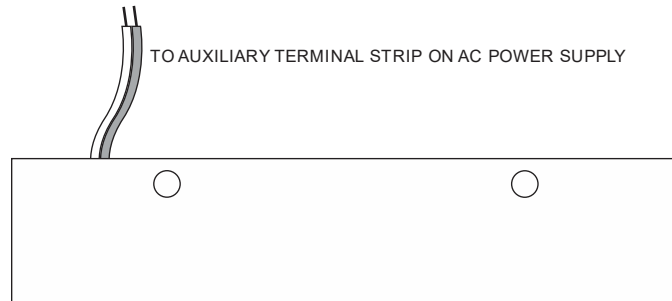

ENCLOSURE SUNSCREEN - Option SCR

Do not mount instrument electronics in direct sunlight. Overheating will reduce the life of electronic components and condensate may form during the heat/cool cycles and cause electrical shorts.

Note:

Exposure to direct sunlight can cause overheating and moisture condensation which will reduce the operating life of electronics.

Protect Instruments from direct sunlight with this iridite finished aluminum sun screen (Option SCR).

Seal conduit entries with caulking compound to further reduce moisture condensation.

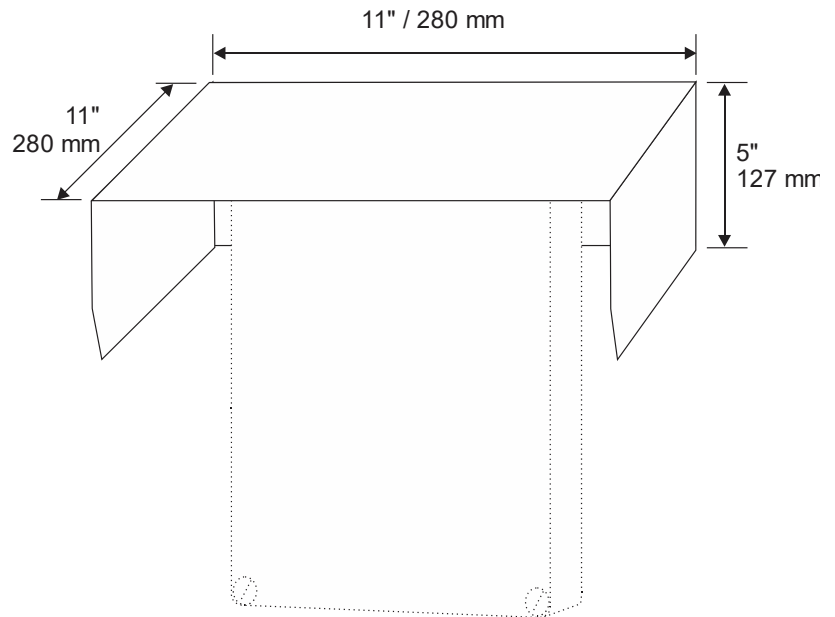

POWER INPUT OPTION
9-32VDC

TTFM 6.1 Flow Meters may be ordered factory-configured for 9-32VDC power input, or a 9-32VDC Power Input card can be installed in the place of the 100-240VAC card in the field.

9-32VDC VERSION CONNECTIONS:

POWER INPUT: Connect 9-32VDC to the + and - terminals. The Power Input GND terminal must be connected to the nearest Ground pole. A 1 amp fuse in line is recommended.

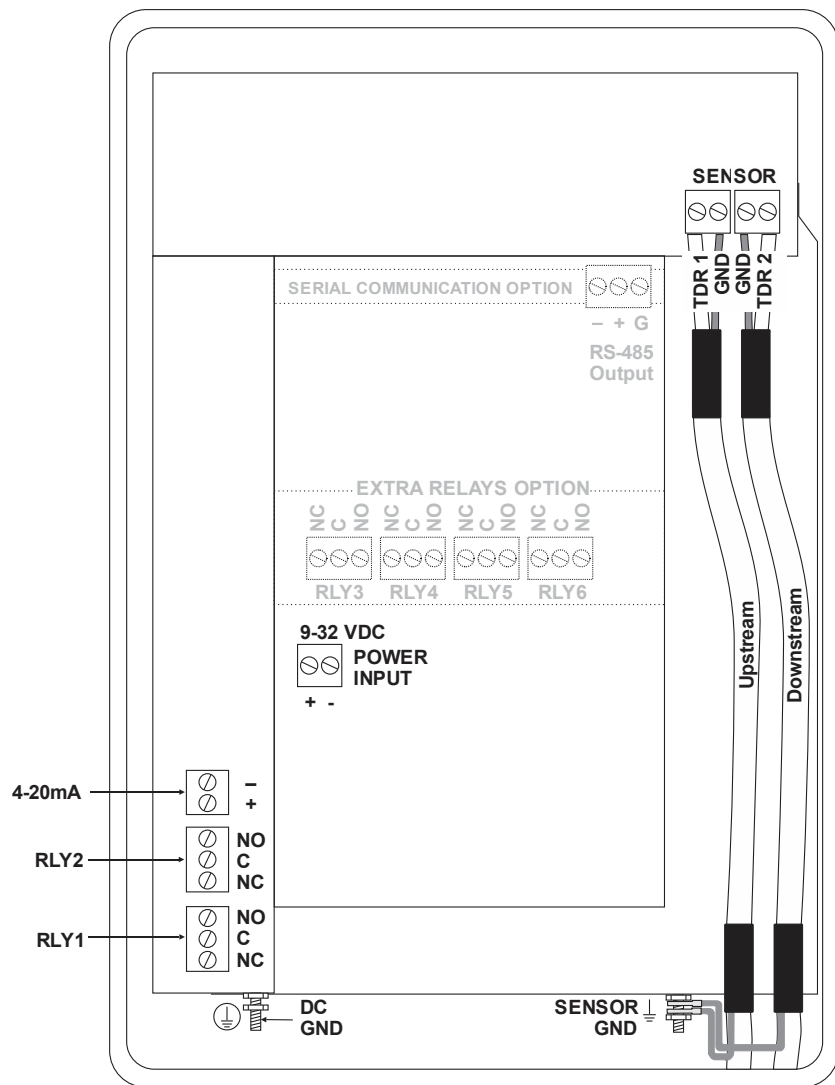

APPENDIX A – Classified Area Installation Control Drawings

Please check the labels on the side of your SE16 transducers to verify which of the following control drawings apply.

SESPEC-INST-03: SE16B Certified CSA C/US Intrinsically Safe for Class I, Div 1, Groups C,D; Class II, Groups E,F,G; Class III

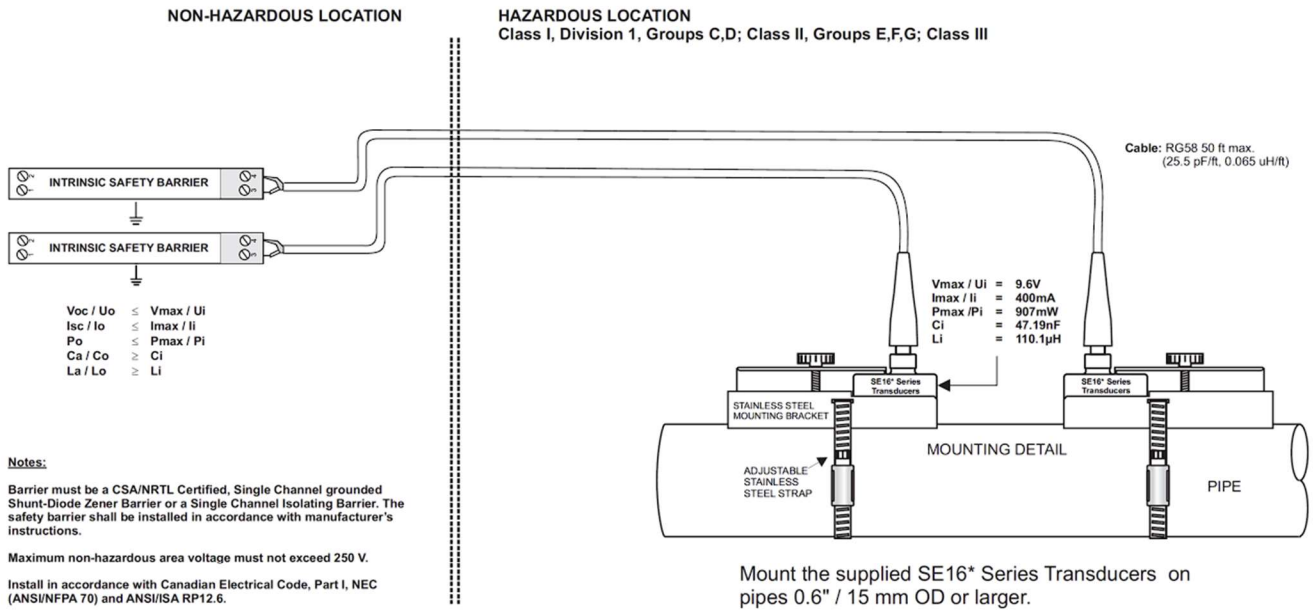

SESPEC-INST-06: SE16B Certified CSA C/US Non-Incendive for Class 1 Div 2, Groups A,B,C,D

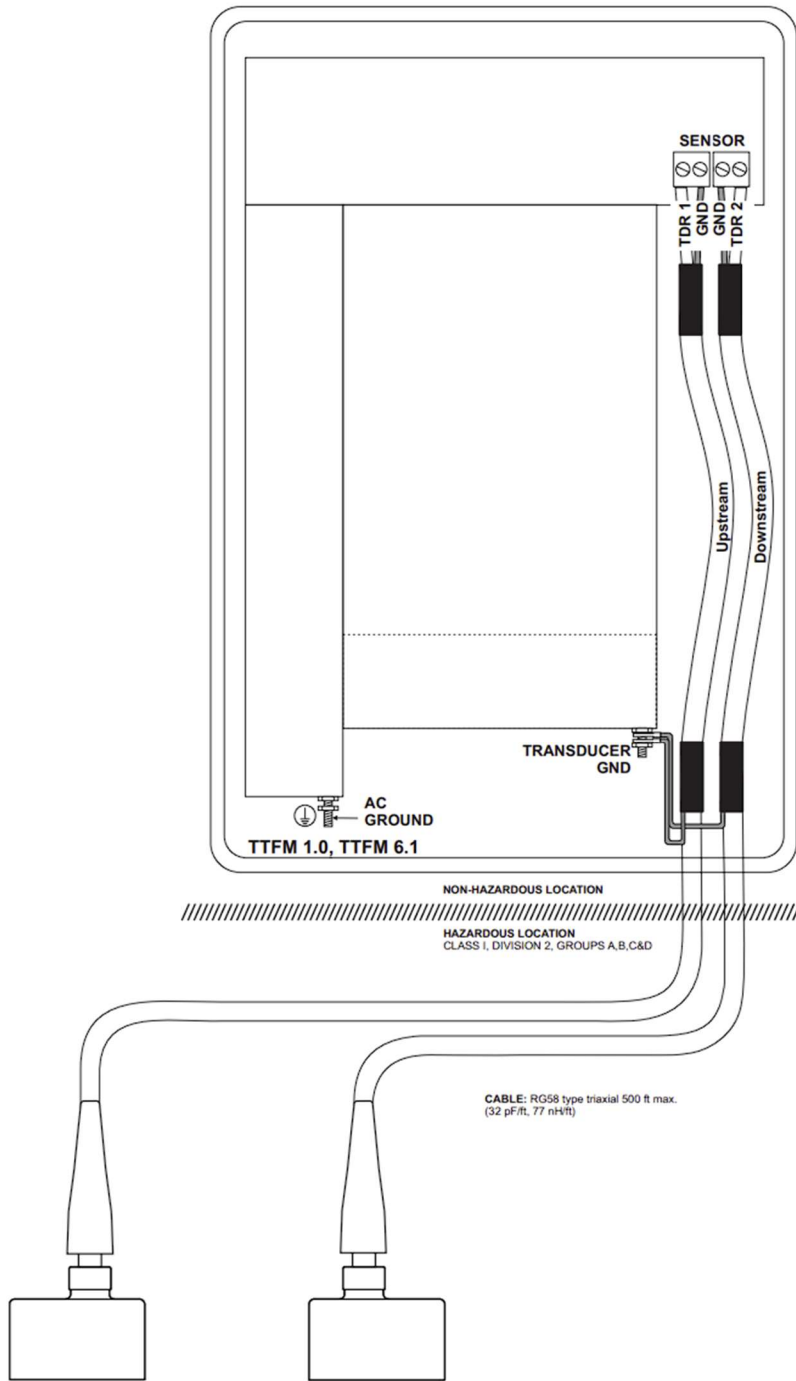

SESPEC-INST-07 Pg 1: SE16A Certified CSA C/US Intrinsically Safe for Class I, Div 1, Groups C,D; Class II, Groups E,F,G; Class III

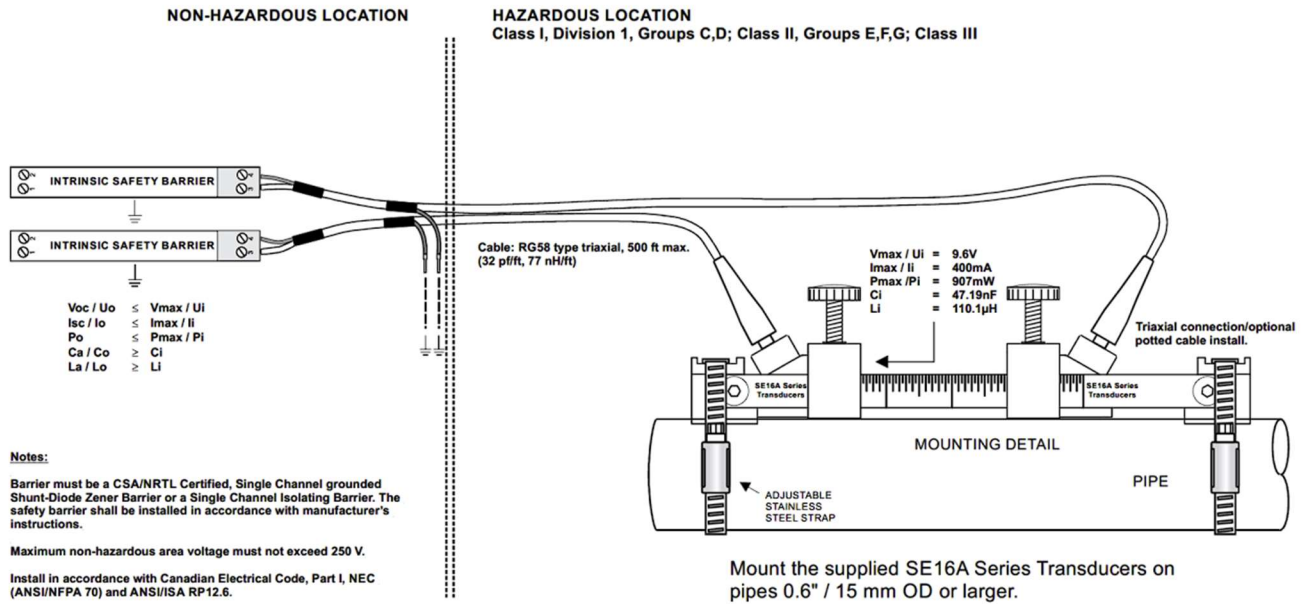

SESPEC-INST-07 Pg 2: SE16A with Sealed Cable Certified CSA C/US Intrinsically Safe for Class I, Div 1, Groups C,D; Class II, Groups E,F,G; Class III

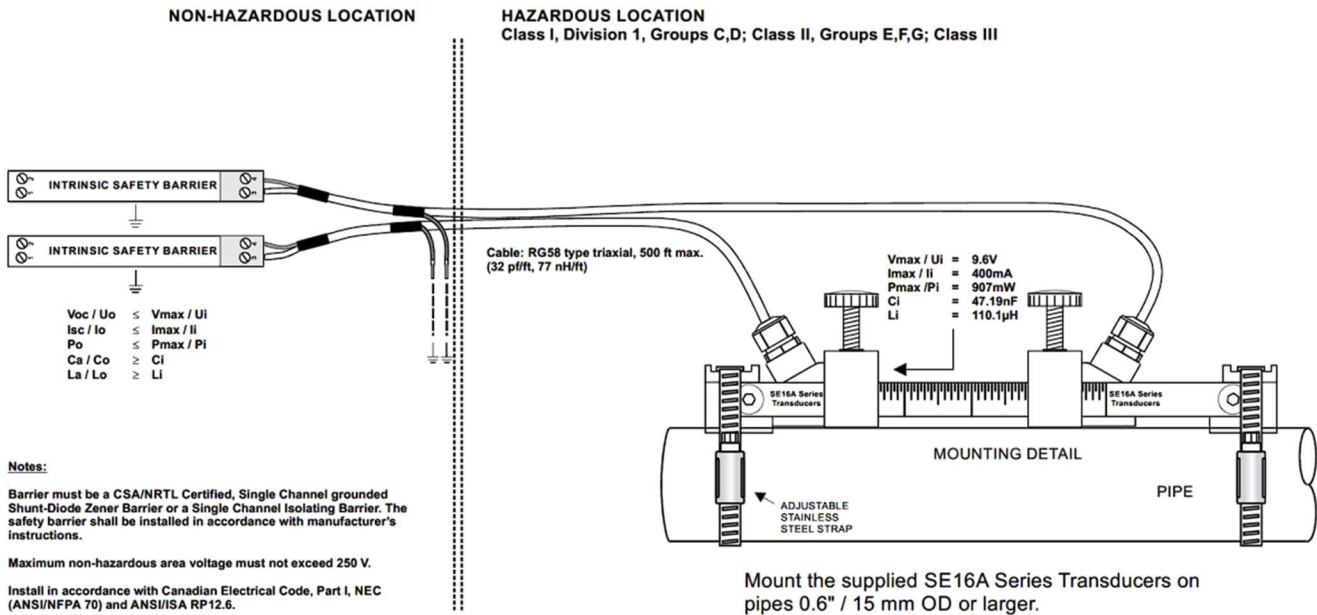

SESPEC-INST-07 Pg 3: SE16A Certified CSA C/US Non-Incendive for Class I, Div 2, Groups A,B,C,D

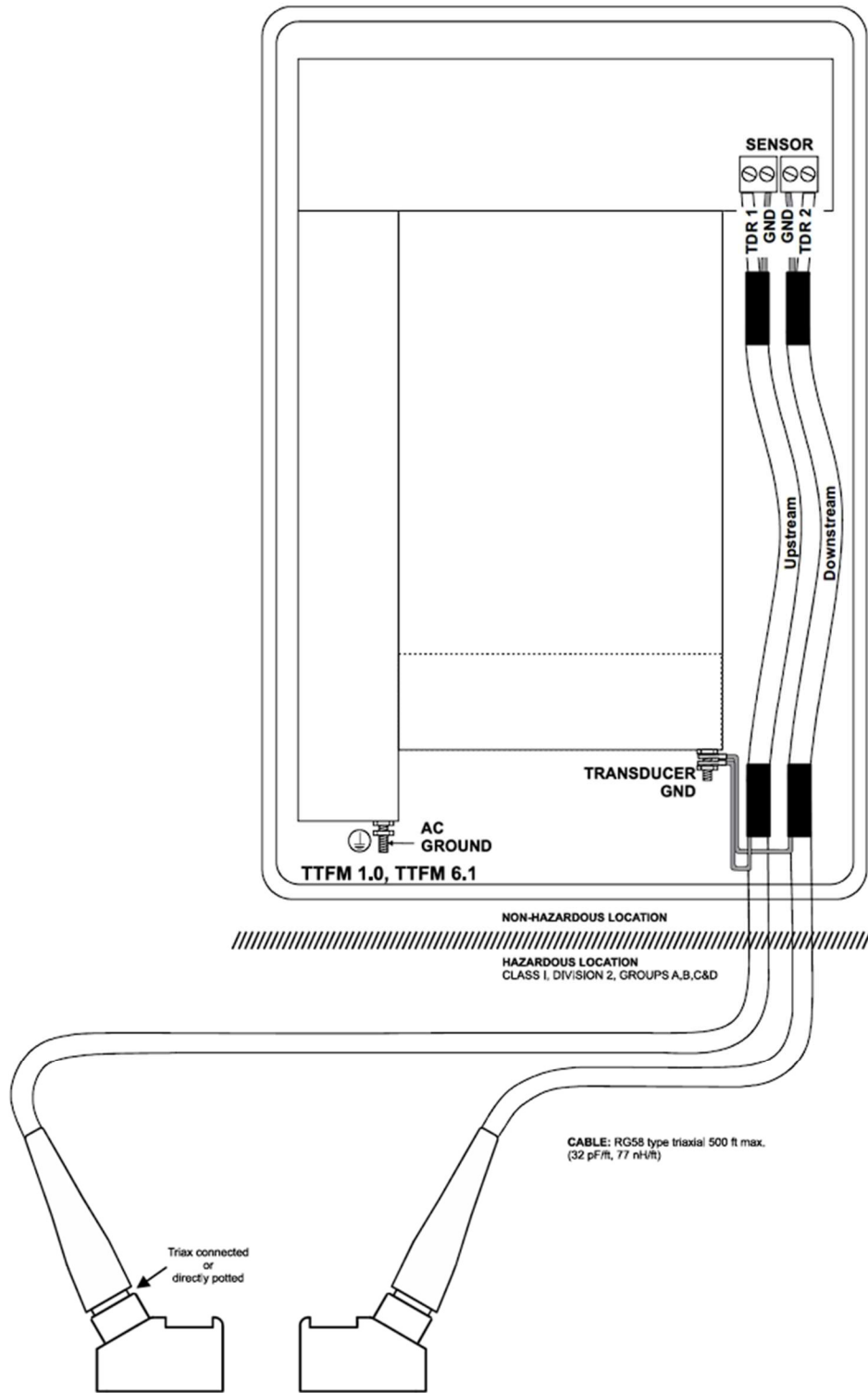

SESPEC-INST-08: SE16C Certified CSA C/US Intrinsically Safe for Class I, Div 1, Groups C,D; Class II, Groups E,F,G; Class III

DRAWING NO: SESPEC-INST-08 REV A

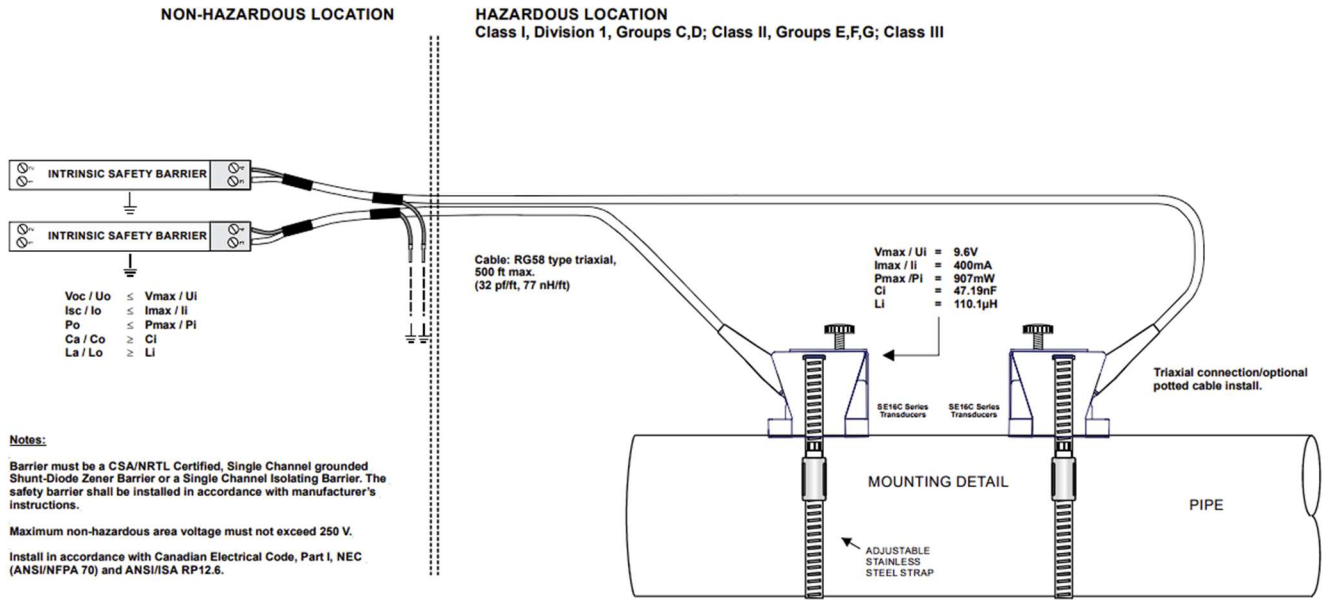

Mount the supplied SE16C Series Transducers on pipes 2.5" / 63.5 mm OD or larger.

SESPEC-INST-09: SE16C Certified CSA C/US Non-Incendive for Class I, Div 2, Groups A,B,C,D

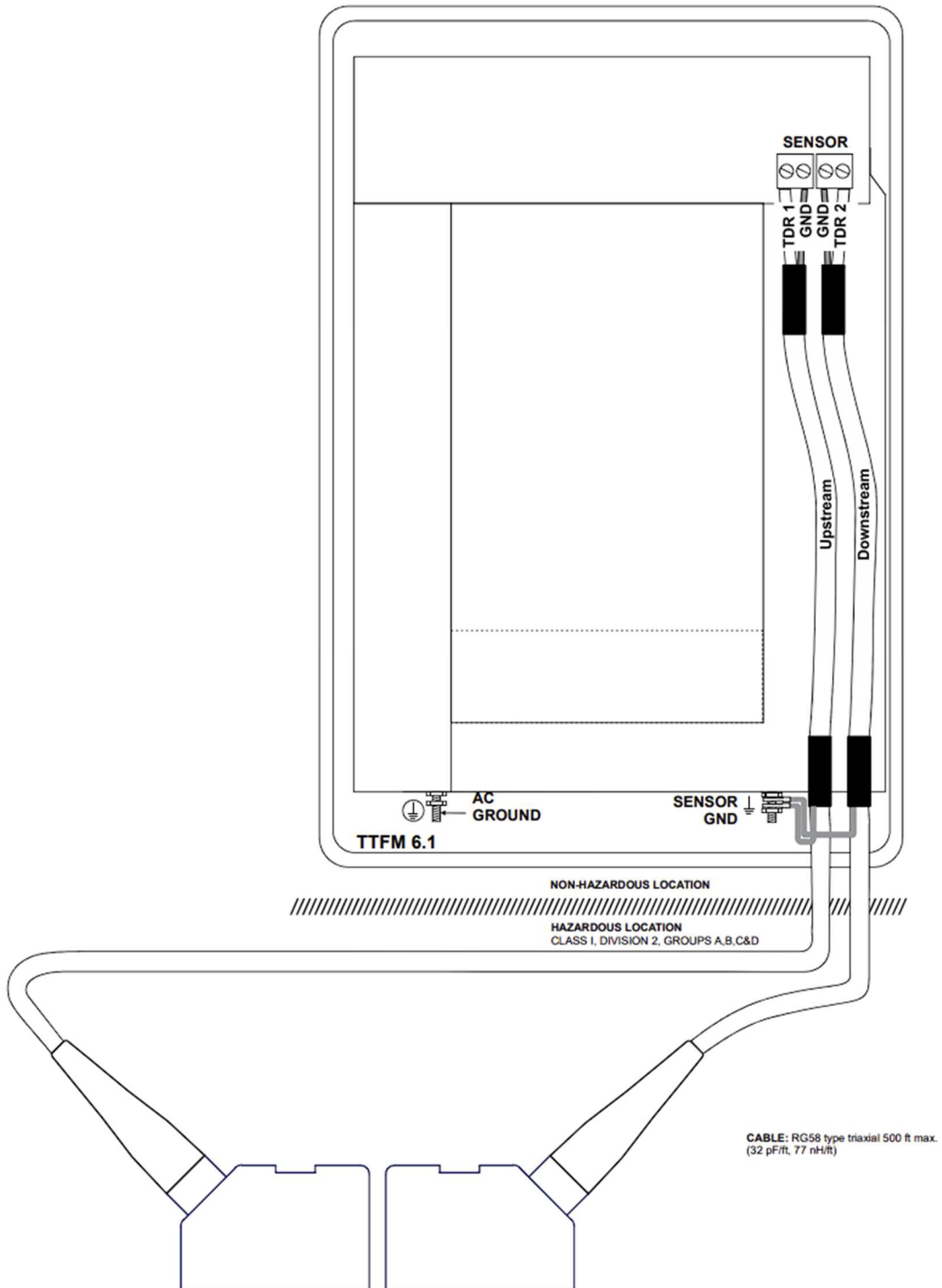

I-0161.01: SE16A Certified ATEX/IECEx Ex ia for Zone 0, Gas group IIB

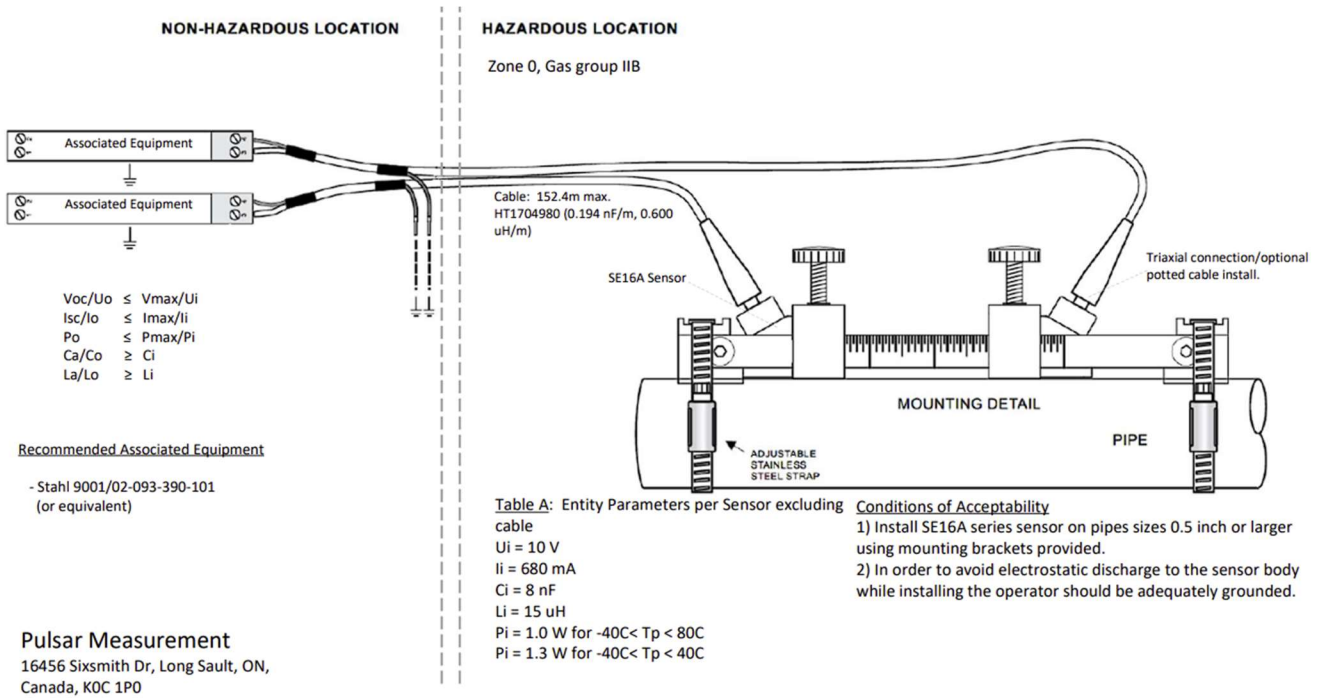

I-0162.01: SE16B Certified ATEX/IECEx Ex ia for Zone 0, Gas group IIB

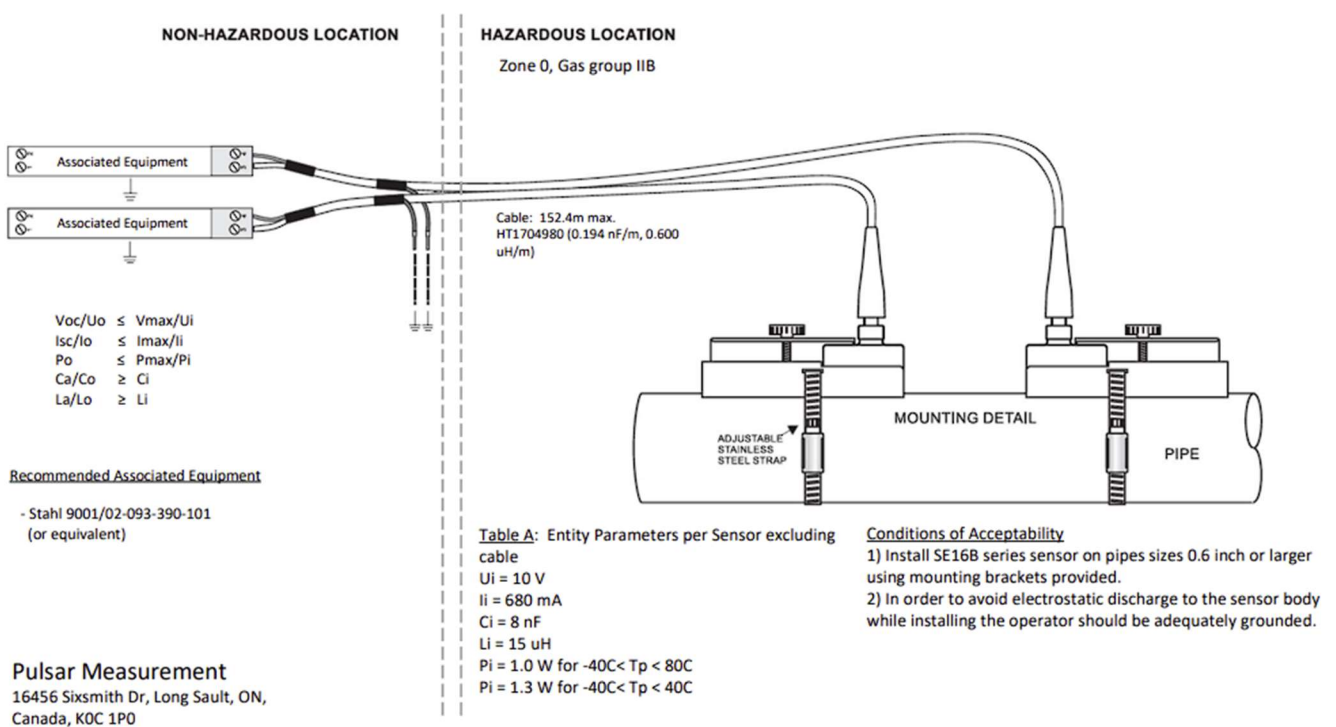

I-0162.01: SE16C Certified ATEX/IECEx Ex ia for Zone 0, Gas group IIB

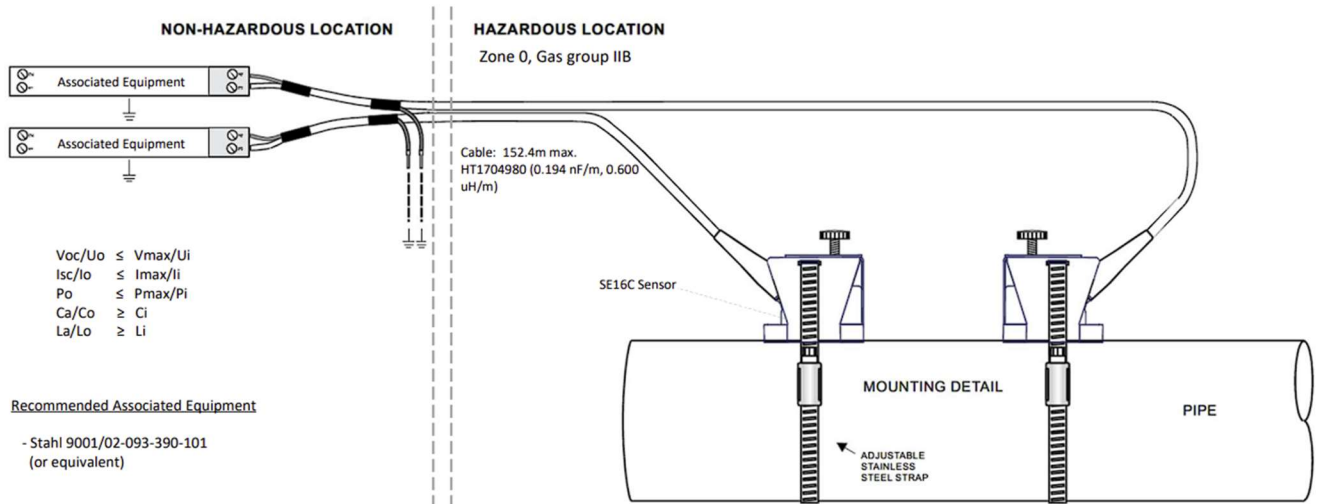

$$\begin{aligned} V_{oc}/U_o &\leq V_{max}/U_i \\ I_{sc}/I_o &\leq I_{max}/I_i \\ P_o &\leq P_{max}/P_i \\ C_a/C_o &\geq C_i \\ L_a/L_o &\geq L_i \end{aligned}$$

Recommended Associated Equipment

- Stahl 9001/02-093-390-101
(or equivalent)

Pulsar Measurement

16456 Sixsmith Dr, Long Sault, ON,
Canada, K0C 1P0

Table A: Entity Parameters per Sensor excluding cable

$U_i = 10 \text{ V}$
 $I_i = 680 \text{ mA}$
 $C_i = 11 \text{ nF}$
 $L_i = 22 \text{ uH}$
 $P_i = 1.0 \text{ W for } -40\text{C} < T_p < 80\text{C}$
 $P_i = 1.3 \text{ W for } -40\text{C} < T_p < 40\text{C}$

Conditions of Acceptability

- 1) Install SE16C series sensor on pipes sizes 1.5 inch or larger using mounting brackets provided.
- 2) In order to avoid electrostatic discharge to the sensor body while installing the operator should be adequately grounded.

APPENDIX B – Specifications

Flow Rate Range:	±0.07 to 40 ft/sec (±0.02 to 12 m/sec)	
Pipe Size:	½" to 48" (15 to 1200 mm)	
Accuracy:	±1% of flow rate from 1.5 to 40 ft/sec, ±0.015 ft/sec below 1.5 ft/sec. Repeatability and Linearity: ±0.25%	
Displays:	White, backlit matrix - displays flow rate, totalizer, relay states, operating mode and calibration menu	
Calibration:	built-in 5-key calibrator with English, French or Spanish language selection	
Power Input:	100-240VAC, 50/60Hz, 10VA or Optional 9-32VDC, 10 Watts Maximum	
Output:	Isolated 4-20mA (1000 ohm load max.). Can be changed to 0-5VDC in programming	
Data Logger:	128MB Data Storage, 26 million data points	
Control Relays:	Qty 2, rated 5 amp 240VAC SPDT, programmable flow alarm and/or proportional pulse	
Enclosure:	Watertight, dust tight NEMA4X (IP 66) polycarbonate with a clear shatter-proof face	
Environmental Conditions:	Relative humidity up to 80%, -23 to 60°C ambient temperature, maximum 5000 m altitude, pollution degree 4, Installation Category II.	
Electrical Surge Protection:	Sensor, 4-20mA output and AC power input	
Approximate Shipping Weight:	12 lbs (5.5 kg)	

SE16A Transit Time Sensor

- Pipe Diameter:** 0.5" To 6" (15 to 150 mm)
- Operating Temperature:** -40° to 300°F (-40° to 150°C)
- Exposed Materials:** 316SS, Ultem
- Operating Frequency:** 2.56 MHz
- Sensor Cable:** 25 ft (7.6 m)
Optional 50 ft (15 m) or 100 ft (30 m) available, extendable up to 500 ft (150 m) with JB2X optional junction box.
- Submersion Rating:** Withstands accidental submersion pressure up to 10 psi (0.7 Bar)

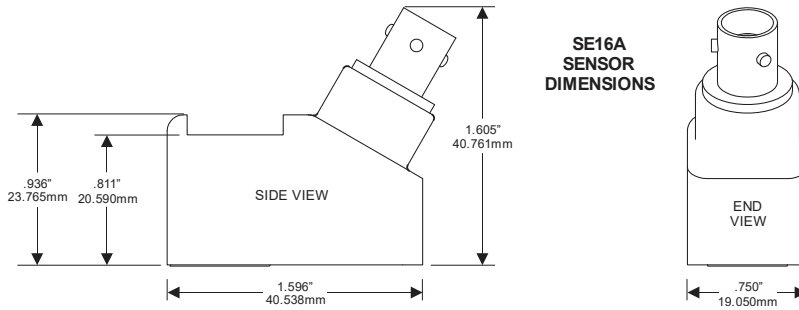

SE16B Transit Time Sensor

- Pipe Diameter:** 2" to 48" (50 to 1200 mm)
- Operating Temperature:** -40° to 300°F (-40° to 150°C)
- Exposed Materials:** 316SS, Ultem
- Operating Frequency:** 1.28 MHz
- Sensor Cable:** 25 ft (7.6 m)
Optional 50 ft (15 m) or 100 ft (30 m) available, extendable up to 500 ft (150 m) with JB2X optional junction box.
- Submersion Rating:** Withstands accidental submersion pressure up to 10 psi (0.7 Bar) when installed with Super Lube® in sealing rubber boot.

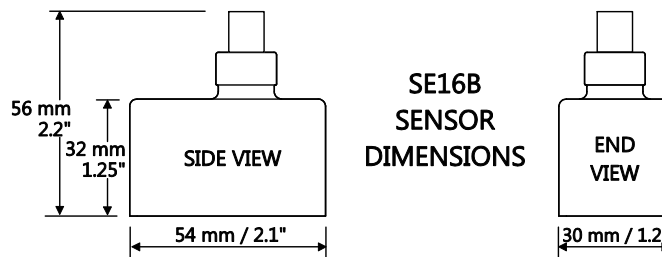

SE16C Transit Time Sensor

- Pipe Diameter:** 4" to 48" (100 mm to 1200 mm)
- Operating Temperature:** -40° to 300°F (-40° to 150°C)
- Exposed Materials:** 316SS, Ultem
- Operating Frequency:** 640 kHz
- Sensor Cable:** 25 ft (7.6 m)
Optional 50 ft (15 m) or 100 ft (30 m) available, extendable up to 500 ft (150 m) with JB2X optional junction box.
- Submersion Rating:** IP67, withstands submersion up to 1 meter (3.3 feet) for up to 30 minutes

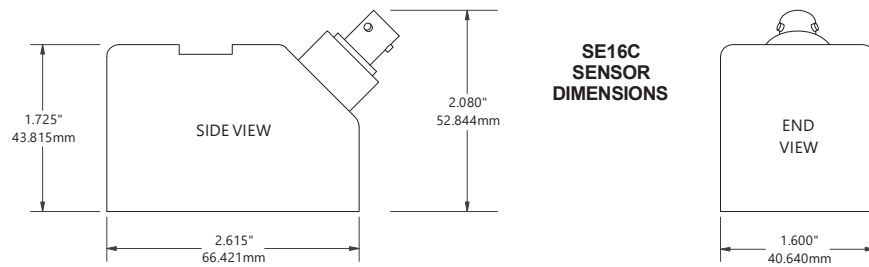

APPENDIX C – Pipe Charts

Note: Not all pipe types allowed in programming have charts below. Pipe dimensions will need to be acquired from pipe markings or the pipe manufacturer in such cases.

Carbon Steel & PVC Pipe

Pipe Size	Pipe O.D.	Schedule Standard		Extra Heavy		Dbl. Extra Heavy		Schedule 10		Schedule 20		Schedule 30		Schedule 40		Schedule 80	
		I.D.	WALL	I.D.	WALL	I.D.	WALL	I.D.	WALL	I.D.	WALL	I.D.	WALL	I.D.	WALL	I.D.	WALL
½	0.840	0.622	0.109											0.622	0.109	0.546	0.147
¾	1.050	0.824	0.113											0.824	0.113	0.742	0.154
1	1.315	1.049	0.133											1.049	0.133	0.957	0.175
1¼	1.660	1.380	0.140											1.380	0.140	1.278	0.191
1½	1.900	1.900	0.145											1.900	0.145	1.500	0.200
2	2.375	2.067	.154	1.939	.218	1.503	.436							2.067	.154	1.939	0.218
2½	2.875	2.469	.203	2.323	.276	1.771	.552							2.469	.203	2.323	0.276
3	3.500	3.068	.216	2.900	.300	2.300	.600							3.068	.216	2.900	0.300
3½	4.000	3.548	.226	3.364	.318	2.728	.636							3.548	.226	3.364	0.318
4	4.500	4.026	.237	3.826	.337	3.152	.674							4.026	.237	3.826	0.337
5	5.563	5.047	.258	4.813	.375	4.063	.750							5.047	.258	4.813	0.375
6	6.625	6.065	.280	5.761	.432	4.897	.864							6.065	.280	5.761	0.432
8	8.625	7.981	.322	7.625	.500	6.875	.875			8.125	.250	8.071	.277	7.981	.322	7.625	0.500
10	10.750	10.020	.365	9.750	.500	8.750	1.000			10.250	.250	10.136	.307	10.020	.365	9.564	0.593
12	12.750	12.000	.375	11.750	.500	10.750	1.000			12.250	.250	12.090	.330	11.938	.406	11.376	0.687
14	14.000	13.250	.375	13.000	.500			13.500	.250	13.376	.312	13.250	.375	13.124	.438	12.500	0.750
16	16.000	15.250	.375	15.000	.500			15.500	.250	15.376	.312	15.250	.375	15.000	.500	14.314	0.843
18	18.000	17.250	.375	17.000	.500			17.500	.250	17.376	.312	17.124	.438	16.876	.562	16.126	0.937
20	20.000	19.250	.375	19.000	.500			19.500	.250	19.250	.375	19.000	.500	18.814	.593	17.938	1.031
22	22.000	21.250	.375	21.000	.500			21.500	.250	21.250	.375	21.000	.500				
24	24.000	23.250	.375	23.000	.500			23.500	.250	23.250	.375	22.876	.562	22.626	.687	21.564	1.218
26	26.000	25.250	.375	25.000	.500			25.376	.312	25.000	.500						
28	28.000	27.250	.375	27.000	.500			27.376	.312	27.000	.500	26.750	.625				
30	30.000	29.250	.375	29.000	.500			29.376	.312	29.000	.500	28.750	.625				
32	32.000	31.250	.375	31.000	.500			31.376	.312	31.000	.500	30.750	.625				
34	34.000	33.250	.375	33.000	.500			33.376	.312	33.000	.500	32.750	.625				
36	36.000	35.250	.375	35.000	.500			35.376	.312	35.000	.500	34.750	.625				
42	42.000	41.250	.375	41.000	.500					41.000	.500	40.750	.625				

Ductile Iron Pipe – Standard Classes

Size INCH	OUTSIDE DIA. INCH	Class 50		Class 51		Class 52		Class 53		Class 54		Class 55		Class 56		CEMENT LINING	
		WALL	I.D.	WALL	I.D.	WALL	I.D.	WALL	I.D.	WALL	I.D.	WALL	I.D.	WALL	I.D.	**STD	**DOUBLE
																THICKNESS	THICKNESS
3	3.96			0.25	3.46	0.28	3.40	0.31	3.34	0.34	3.28	0.37	3.22	0.41	3.14	.125	.250
4	4.80			0.26	4.28	0.29	4.22	0.32	4.16	0.35	4.10	0.38	4.04	0.44	3.93		
6	6.90	0.25	6.40	0.28	6.34	0.31	6.28	0.34	6.22	0.37	6.16	0.40	6.10	0.43	6.04		
8	9.05	0.27	8.51	0.30	8.45	0.33	8.39	0.36	8.33	0.39	8.27	0.42	8.21	0.45	8.15		
10	11.10	0.39	10.32	0.32	10.46	0.35	10.40	0.38	10.34	0.41	10.28	0.44	10.22	0.47	10.16		
12	13.20	0.31	12.58	0.34	12.52	0.37	12.46	0.40	12.40	0.43	12.34	0.46	12.28	0.49	12.22		
14	15.30	0.33	14.64	0.36	14.58	0.39	14.52	0.42	14.46	0.45	14.40	0.48	14.34	0.51	14.28		
16	17.40	0.34	16.72	0.37	16.66	0.40	16.60	0.43	16.54	0.46	16.48	0.49	16.42	0.52	16.36		
18	19.50	0.35	18.80	0.38	18.74	0.41	18.68	0.44	18.62	0.47	18.56	0.50	18.50	0.53	18.44	.1875	.375
20	21.60	0.36	20.88	0.39	20.82	0.42	20.76	0.45	20.70	0.48	20.64	0.51	20.58	0.54	20.52		
24	25.80	0.38	25.04	0.41	24.98	0.44	24.92	0.47	24.86	0.50	24.80	0.53	24.74	0.56	24.68		
30	32.00	0.39	31.22	0.43	31.14	0.47	31.06	0.51	30.98	0.55	30.90	0.59	30.82	0.63	30.74		
36	38.30	0.43	37.44	0.48	37.34	0.62	37.06	0.58	37.14	0.63	37.04	0.68	36.94	0.73	36.84		
42	44.50	0.47	43.56	0.53	43.44	0.59	43.32	0.65	43.20	0.71	43.08	0.77	42.96	0.83	42.84	.250	.500
48	50.80	0.51	49.78	0.58	49.64	0.65	49.50	0.72	49.36	0.79	49.22	0.86	49.08	0.93	48.94		
54	57.10	0.57	55.96	0.65	55.80	0.73	55.64	0.81	55.48	0.89	55.32	0.97	55.16	1.05	55.00		

**REDUCE I.D. BY DIMENSION SHOWN

Stainless Steel, Hastelloy "C" & Titanium Pipe

Pipe Size	Pipe O.D.	Schedule 5 S (a)		Schedule 10 S (a)		Schedule 40 S		Schedule 80 S	
		I.D.	WALL	I.D.	WALL	I.D.	WALL	I.D.	WALL
1/2	0.840	0.710	0.065	0.674	0.083	0.622	0.109	0.546	0.147
3/4	1.050	0.920	0.065	0.884	0.083	0.824	0.113	0.742	0.154
1	1.315	1.185	0.065	1.097	0.109	1.049	0.133	0.957	0.175
1 1/4	1.660	1.530	0.065	1.442	0.109	1.380	0.140	1.278	0.191
1 1/2	1.900	1.770	0.065	1.682	0.109	1.900	0.145	1.500	0.200
2	2.375	2.245	.065	2.157	.109	2.067	.154	1.939	.218
2 1/2	2.875	2.709	.083	2.635	.120	2.469	.203	2.323	.276
3	3.500	3.334	.083	3.260	.120	3.068	.216	2.900	.300
3 1/2	4.000	3.834	.083	3.760	.120	3.548	.226	3.364	.318
4	4.500	4.334	.083	4.260	.120	4.026	.237	3.826	.337
5	5.563	5.345	.109	5.295	.134	5.047	.258	4.813	.375
6	6.625	6.407	.109	6.357	.134	6.065	.280	5.761	.432
8	8.625	8.407	.109	8.329	.148	7.981	.322	7.625	.500
10	10.750	10.482	.134	10.420	.165	10.020	.365	9.750	.500
12	12.750	12.438	.156	12.390	.180	12.000	.375	11.750	.500
14	14.000	13.688	.156	13.624	.188				
16	16.000	15.670	.165	15.624	.188				
18	18.000	17.670	.165	17.624	.188				
20	20.000	19.634	.188	19.564	.218				
22	22.000	21.624	.188	21.564	.218				
24	24.000	23.563	.218	23.500	.250				

Pipe Size	Pipe O.D.	Schedule 60		Schedule 80		Schedule 100		Schedule 120		Schedule 140		Schedule 160	
		I.D.	WALL	I.D.	WALL	I.D.	WALL	I.D.	WALL	I.D.	WALL	I.D.	WALL
2	2.375			1.939	.218							1.689	.343
2 1/2	2.875			2.323	.276							2.125	.375
3	3.500			2.900	.300							2.624	.438
3 1/2	4.000			3.364	.318								
4	4.500			3.826	.337			3.624	.438			3.438	.531
5	5.563			4.813	.375			4.563	.500			4.313	.625
6	6.625			5.761	.432			5.501	.562			5.189	.718
8	8.625	7.813	.406	7.625	.500	7.439	.593	7.189	.718	7.001	.812	6.813	.906
10	10.750	9.750	.500	9.564	.593	9.314	.718	9.064	.843	8.750	1.000	8.500	1.125
12	12.750	11.626	.562	11.376	.687	11.064	.843	10.750	1.000	10.500	1.125	10.126	1.312
14	14.000	12.814	.593	12.500	.750	12.126	.937	11.814	1.093	11.500	1.250	11.188	1.406
16	16.000	14.688	.656	14.314	.843	13.938	1.031	13.564	1.218	13.124	1.438	12.814	1.593
18	18.000	16.500	.750	16.126	.937	15.688	1.156	15.250	1.375	14.876	1.562	14.438	1.781
20	20.000	18.376	.812	17.938	1.031	17.438	1.281	17.000	1.500	16.500	1.750	16.064	1.968
22	22.000	20.250	.875	19.750	1.125	19.250	1.375	18.750	1.625	18.250	1.875	17.750	2.125

Cast Iron Pipe - ASA Standard

Pipe Size	Pipe O.D.	Class 50		Class 100		Class 150		Class 200		Class 250		Class 300		Class 350	
		WALL	I.D.	WALL	I.D.	WALL	I.D.	WALL	I.D.	WALL	I.D.	WALL	I.D.	WALL	I.D.
3	3.96	0.32	3.32	0.32	3.32	0.32	3.32	0.32	3.32	0.32	3.32	0.32	3.32	0.32	3.32
4	4.80	0.35	4.10	0.35	4.10	0.35	4.10	0.35	4.10	0.35	4.10	0.35	4.10	0.35	4.10
6	6.90	0.38	6.14	0.38	6.14	0.38	6.14	0.38	6.14	0.38	6.14	0.38	6.14	0.38	6.14
8	9.05	0.41	8.23	0.41	8.23	0.41	8.23	0.41	8.23	0.41	8.23	0.41	8.23	0.41	8.23
10	11.10	0.44	10.22	0.44	10.22	0.44	10.22	0.44	10.22	0.44	10.22	0.48	10.14	0.52	10.06
12	13.20	0.48	12.24	0.48	12.24	0.48	12.24	0.48	12.24	0.52	12.16	0.52	12.16	0.56	12.08
14	15.30	0.48	14.34	0.51	14.28	0.51	14.28	0.55	14.20	0.59	14.12	0.59	14.12	0.64	14.02
16	17.40	0.54	16.32	0.54	16.32	0.54	16.32	0.58	16.24	0.63	16.14	0.68	16.04	0.68	16.04
18	19.50	0.54	18.42	0.58	18.34	0.58	18.34	0.63	18.24	0.68	18.14	0.73	18.04	0.79	17.92
20	21.60	0.57	20.46	0.62	20.36	0.62	20.36	0.67	20.26	0.72	20.16	0.78	20.04	0.84	19.92
24	25.80	0.63	24.54	0.68	24.44	0.73	24.34	0.79	24.22	0.79	24.22	0.85	24.10	0.92	23.96

Cast Iron Pipe - AWWA Standard

Pipe Size	Class A 100 Ft. 43 PSIG			Class B 200 Ft. 86 PSIG			Class C 300 Ft. 130 PSIG			Class D 400 Ft. 173 PSIG		
	O.D.	WALL	I.D.	O.D.	WALL	I.D.	O.D.	WALL	I.D.	O.D.	WALL	I.D.
3	3.80	0.39	3.02	3.96	0.42	3.12	3.96	0.45	3.06	3.96	0.48	3.00
4	4.80	0.42	3.96	5.00	0.45	4.10	5.00	0.48	4.04	5.00	0.52	3.96
6	6.90	0.44	6.02	7.10	0.48	6.14	7.10	0.51	6.08	7.10	0.55	6.00
8	9.05	0.46	8.13	9.05	0.51	8.03	9.30	0.56	8.18	9.30	0.60	8.10
10	11.10	0.50	10.10	11.10	0.57	9.96	11.40	0.62	10.16	11.40	0.68	10.04
12	13.20	0.54	12.12	13.20	0.62	11.96	13.50	0.68	12.14	13.50	0.75	12.00
14	15.30	0.57	14.16	15.30	0.66	13.98	15.65	0.74	14.17	15.65	0.82	14.01
16	17.40	0.60	16.20	17.40	0.70	16.00	17.80	0.80	16.20	17.80	0.89	16.02
18	19.50	0.64	18.22	19.50	0.75	18.00	19.92	0.87	18.18	19.92	0.96	18.00
20	21.60	0.67	20.26	21.60	0.80	20.00	22.06	0.92	20.22	22.06	1.03	20.00
24	25.80	0.76	24.28	25.80	0.89	24.02	26.32	1.04	24.22	26.32	1.16	24.00
30	31.74	0.88	29.98	32.00	1.03	29.94	32.40	1.20	30.00	32.74	1.37	30.00
36	37.96	0.99	35.98	38.30	1.15	36.00	38.70	1.36	39.98	39.16	1.58	36.00
42	44.20	1.10	42.00	44.50	1.28	41.94	45.10	1.54	42.02	45.58	1.78	42.02
48	50.50	1.26	47.98	50.80	1.42	47.96	51.40	1.71	47.98	51.98	1.96	48.06
54	56.66	1.35	53.96	57.10	1.55	54.00	57.80	1.90	54.00	58.40	2.23	53.94
60	62.80	1.39	60.02	63.40	1.67	60.06	64.20	2.00	60.20	64.82	2.38	60.06
72	75.34	1.62	72.10	76.00	1.95	72.10	76.88	2.39	72.10			
84	87.54	1.72	84.10	88.54	2.22	84.10						

Pipe Size	Class E 500 Ft. 217 PSIG			Class F 600 Ft. 260 PSIG			Class G 700 Ft. 304 PSIG			Class H 800 Ft. 347 PSIG		
	O.D.	WALL	I.D.	O.D.	WALL	I.D.	O.D.	WALL	I.D.	O.D.	WALL	I.D.
6	7.22	0.58	6.06	7.22	0.61	6.00	7.38	0.65	6.08	7.38	0.69	6.00
8	9.42	0.66	8.10	9.42	0.71	8.00	9.60	0.75	8.10	9.60	0.80	8.00
10	11.60	0.74	10.12	11.60	0.80	10.00	11.84	0.86	10.12	11.84	0.92	10.00
12	13.78	0.82	12.14	13.78	0.89	12.00	14.08	0.97	12.14	14.08	1.04	12.00
14	15.98	0.90	14.18	15.98	0.99	14.00	16.32	1.07	14.18	16.32	1.16	14.00
16	18.16	0.98	16.20	18.16	1.08	16.00	18.54	1.18	16.18	18.54	1.27	16.00
18	20.34	1.07	18.20	20.34	1.17	18.00	20.78	1.28	18.22	20.78	1.39	18.00
20	22.54	1.15	20.24	22.54	1.27	20.00	23.02	1.39	20.24	23.02	1.51	20.00
24	26.90	1.31	24.28	26.90	1.45	24.00	27.76	1.75	24.26	27.76	1.88	24.00
30	33.10	1.55	30.00	33.46	1.73	30.00						
36	39.60	1.80	36.00	40.04	2.02	36.00						

Copper Tubing

Pipe Size	K			L			M			Copper & Brass Pipe			Aluminum		
	O.D.	I.D.	WALL	O.D.	I.D.	WALL	O.D.	I.D.	WALL	O.D.	I.D.	WALL	O.D.	I.D.	WALL
1/2"	0.625	0.527	0.049	0.625	0.545	0.040	0.625	0.569	0.028						
3/4"	0.875	0.745	0.065	0.875	0.785	0.045	0.875	0.811	0.032						
1"	1.125	0.995	0.065	1.125	1.025	0.050	1.125	1.055	0.035						
1 1/4"	1.375	1.245	0.065	1.375	1.265	0.055	1.375	1.291	0.042						
1 1/2"	1.625	1.481	0.072	1.625	1.505	0.060	1.625	1.527	0.049						
2"	2.125	1.959	0.083	2.125	1.985	0.070	2.125	2.009	0.058	2.375	2.062	0.157			
2 1/2"	2.625	2.435	0.095	2.625	2.465	0.080	2.625	2.495	0.065	2.875	2.500	0.188	2.500	2.400	0.050
3"	3.125	2.907	0.109	3.125	2.945	0.090	3.125	2.981	0.072	3.500	3.062	0.219	3.000	2.900	0.050
3 1/2"	3.625	3.385	0.120	3.625	3.425	0.100	3.625	3.459	0.083	4.000	3.500	0.250			
4"	4.125	3.857	0.134	4.125	3.905	0.110	4.125	3.935	0.095	4.500	3.935	0.095	4.000	4.000	0.250
4 1/2"													5.000	4.500	0.250
5"	5.125	4.805	0.160	5.125	4.875	0.125	5.125	4.907	0.109	5.563	5.063	0.250	5.000	4.874	0.063
6"	6.125	5.741	0.192	6.125	5.845	0.140	6.125	5.881	0.122	6.625	6.125	0.250	6.000	5.874	0.063
7"										7.625	7.062	0.282	7.000	6.844	0.078
8"	8.125	7.583	0.271	8.125	7.725	0.200	8.125	7.785	0.170	8.625	8.000	0.313	8.000	7.812	0.094
10"	10.125	9.449	0.338	10.125	9.625	0.250	10.125	9.701	0.212	10.000	9.812	0.094			
12"	12.125	11.315	0.405	12.125	11.565	0.280	12.125	11.617	0.254						

HDPE

Pipe Size	OD	DR 7		DR 7.3		DR 9		DR 11		DR 13.5		DR 15.5	
		Wall	ID	Wall	ID	Wall	ID	Wall	ID	Wall	ID	Wall	ID
2"	2.375"	0.339"	1.656"	0.325"	1.685"	0.264"	1.816"	0.216"	1.917"	0.176"	2.002"	0.153"	2.050"
3"	3.500"	0.500"	2.440"	0.479"	2.484"	0.389"	2.676"	0.318"	2.825"	0.259"	2.950"	0.226"	3.021"
4"	4.500"	0.643"	3.137"	0.616"	3.193"	0.500"	3.440"	0.409"	3.633"	0.333"	3.793"	0.290"	3.885"
5"	5.563"	0.795"	3.878"	0.762"	3.947"	0.618"	4.253"	0.506"	4.491"	0.412"	4.689"	0.347"	4.640"
6"	6.625"	0.946"	4.619"	0.908"	4.701"	0.736"	5.064"	0.602"	5.348"	0.491"	5.585"	0.359"	4.802"
7"	7.125"	1.018"	4.967"	0.976"	5.056"	0.792"	5.447"	0.648"	5.752"	0.528"	6.006"	0.427"	5.719"
8"	8.625"	1.232"	6.013"	1.182"	6.120"	0.958"	6.593"	0.784"	6.963"	0.639"	7.271"	0.460"	6.150"
10"	10.750"	1.536"	7.494"	1.473"	7.628"	1.194"	8.218"	0.977"	8.678"	0.796"	9.062"	0.556"	7.445"
12"	12.750"	1.821"	8.889"	1.747"	9.047"	1.417"	9.747"	1.159"	10.293"	0.944"	10.748"	0.694"	9.280"
14"	14.000"	2.000"	9.760"	1.918"	9.934"	1.556"	10.702"	1.273"	11.302"	1.037"	11.801"	0.823"	11.006"
16"	16.00"	2.286"	11.154"	2.192"	11.353"	1.778"	12.231"	1.455"	12.916"	1.185"	13.487"	0.903"	12.085"
18"	18.00"	2.571"	12.549"	2.466"	12.773"	2.000"	13.760"	1.636"	14.531"	1.333"	15.173"	1.032"	13.812"
20"	20.00"	2.857"	13.943"	2.740"	14.192"	2.222"	15.289"	1.818"	16.145"	1.481"	16.859"	1.161"	15.538"
22"	22.00"	3.143"	15.337"	3.014"	15.611"	2.444"	16.818"	2.000"	17.760"	1.630"	18.545"	1.290"	17.265"
24"	24.00"	3.429"	16.731"	3.288"	17.030"	2.667"	18.347"	2.182"	19.375"	1.778"	20.231"	1.419"	18.991"
26"	26.00"	--	--	3.562"	18.449"	2.889"	19.876"	2.364"	20.989"	1.926"	21.917"	1.548"	20.717"
28"	28.00"	--	--	--	--	3.111"	21.404"	2.545"	22.604"	2.074"	23.603"	1.677"	22.444"
30"	30.00"	--	--	--	--	3.333"	22.933"	2.727"	24.218"	2.222"	25.289"	1.806"	24.170"
32"	32.00"	--	--	--	--	3.556"	24.462"	2.909"	25.833"	2.370"	26.975"	1.935"	25.897"
34"	34.00"	--	--	--	--	--	--	3.091"	27.447"	2.519"	28.661"	2.065"	27.623"
36"	36.00"	--	--	--	--	--	--	3.273"	29.062"	2.667"	30.347"	2.194"	29.350"
42"	42.00"	--	--	--	--	--	--	--	--	3.111"	35.404"	2.323"	31.076"
48"	48.00"	--	--	--	--	--	--	--	--	3.556"	40.462"	2.710"	36.255"

C900/C905 PVC AWWA Water Distribution Pipe (Blue)

Pipe Size	OD	DR14		DR18		DR-21		DR25	
		Wall	ID	Wall	ID	Wall	ID	Wall	ID
4	4.80	0.343	4.114	0.267	4.266			0.192	4.416
6	6.90	0.493	5.914	0.383	6.134			0.276	6.348
8	9.05	0.646	7.758	0.503	8.044			0.362	8.326
10	11.10	0.793	9.514	0.617	9.866			0.444	10.212
12	13.20	0.943	11.314	0.733	11.734			0.528	12.144
14	15.30			0.850	13.600	0.729	13.842	0.612	14.076
16	17.40			0.967	15.466	0.829	15.742	0.696	16.008
18	19.50			1.083	17.334	0.929	17.642	0.780	17.94
20	21.60			1.200	19.200	1.029	19.542	0.864	19.872
24	25.80			1.433	22.934	1.229	23.342	1.032	23.736

APPENDIX D – Speed of Sound for Various Fluids

Substance	Form Index	Specific Gravity	Sound Speed m/sec.	v/°C - m/s/°C Δ
Acetic anhydride (22)	(CH ₃ CO) ₂ O	1.082 (20°C)	1180	2.5
Acetic acid, anhydride (22)	(CH ₃ CO) ₂ O	1.082 (20°C)	1180	2.5
Acetic acid, nitrile	C ₂ H ₃ N	0.783	1290	4.1
Acetic acid, ethyl ester (33)	C ₄ H ₈ O ₂	0.901	1085	4.4
Acetic acid, methyl ester	C ₃ H ₆ O ₂	0.934	1211	
Acetone	C ₃ H ₆ O	0.791	1174	4.5
Acetonitrile	C ₂ H ₃ N	0.783	1290	4.1
Acetylacetone	C ₆ H ₁₀ O ₂	0.729	1399	3.6
Acetylene dichloride	C ₂ H ₂ Cl ₂	1.26	1015	3.8
Acetylene tetrabromide (47)	C ₂ H ₂ Br ₄	2.966	1027	
Acetylene tetrachloride (47)	C ₂ H ₂ Cl ₄	1.595	1147	
Alcohol	C ₂ H ₆ O	0.789	1207	4.0
Alkazene-13	C ₁₅ H ₂₄	0.86	1317	3.9
Alkazene-25	C ₁₀ H ₁₂ Cl ₂	1.20	1307	3.4
2-Amino-ethanol	C ₂ H ₇ NO	1.018	1724	3.4
2-Aminotolidine (46)	C ₇ H ₉ N	0.999 (20°C)	1618	
4-Aminotolidine (46)	C ₇ H ₉ N	0.966 (45°C)	1480	
Ammonia (35)	NH ₃	0.771	1729	6.68
Amorphous Polyolefin		0.98	962.6	
t-Amyl alcohol	C ₅ H ₁₂ O	0.81	1204	
Aminobenzene (41)	C ₆ H ₅ NO ₂	1.022	1639	4.0
Aniline (41)	C ₆ H ₅ NO ₂	1.022	1639	4.0
Argon (45)	Ar	1.400 (-188°C)	853	
Azine	C ₆ H ₅ N	0.982	1415	4.1
Benzene (29,40,41)	C ₆ H ₆	0.879	1306	4.65
Benzol(29,40,41)	C ₆ H ₆	0.879	1306	4.65
Bromine (21)	Br ₂	2.928	889	3.0
Bromo-benzene (46)	C ₆ H ₅ Br	1.522	1170	
1-Bromo-butane (46)	C ₄ H ₉ Br	1.276 (20°C)	1019	
Bromo-ethane (46)	C ₂ H ₅ Br	1.460 (20°C)	900	
Bromoform (46,47)	CHBr ₃	2.89 (20°C)	918	3.1
n-Butane (2)	C ₄ H ₁₀	0.601 (0°C)	1085	5.8
2-Butanol	C ₄ H ₁₀ O	0.81	1240	3.3
sec-Butylalcohol	C ₄ H ₁₀ O	0.81	1240	3.3
n-Butyl bromide (46)	C ₄ H ₉ Br	1.276 (20°C)	1019	
n-Butyl chloride (22,46)	C ₄ H ₉ Cl	0.887	1140	4.57
tert Butyl chloride	C ₄ H ₉ Cl	0.84	984	4.2
Butyl oleate	C ₂₂ H ₄₂ O ₂		1404	3.0
2,3 Butylene glycol	C ₄ H ₁₀ O ₂	1.019	1484	1.51
Cadmium (7)	Cd		2237.7	
Carbinol (40,41)	CH ₄ O	0.791 (20°C)	1076	2.92

Substance	Form Index	Specific Gravity	Sound Speed m/sec.	v/°C - m/s/°C Δ
Carbitol	C ₆ H ₁₄ O ₃	0.988	1458	
Carbon dioxide (26)	CO ₂	1.101 (-37°C)	839	7.71
Carbon disulphide	CS ₂	1.261 (22°C)	1149	
Carbon tetrachloride(33,35,47)	CCl ₄	1.595 (20°C)	926	2.48
Carbon tetrafluoride (14)	CF ₄	1.75 (-150°C)	875.2	6.61
Cetane (23)	C ₁₆ H ₃₄	0.773 (20°C)	1338	3.71
Chloro-benezene	C ₆ H ₅ Cl	1.106	1273	3.6
1-Chloro-butane (22,46)	C ₄ H ₉ Cl	0.887	1140	4.57
Chloro-diFluoromethane (3) (Freon 22)	CHClF ₂	1.491 (-69°C)	893.9	4.79
Chloroform (47)	CHCl ₃	1.489	979	3.4
1-Chloro-propane (47)	C ₃ H ₇ Cl	0.892	1058	
Chlorotrifluoromethane (5)	CClF ₃		724	5.26
Cinnamaldehyde	C ₉ H ₈ O	1.112	1554	3.2
Cinnamic aldehyde	C ₉ H ₈ O	1.112	1554	3.2
Colamine	C ₂ H ₇ NO	1.018	1724	3.4
o-Cresol (46)	C ₇ H ₈ O	1.047 (20°C)	1541	
m-Cresol (46)	C ₇ H ₈ O	1.034 (20°C)	1500	
Cyanomethane	C ₂ H ₃ N	0.783	1290	4.1
Cyclohexane (15)	C ₆ H ₁₂	0.779 (20°C)	1248	5.41
Cyclohexanol	C ₆ H ₁₂ O	0.962	1454	3.6
Cyclohexanone	C ₆ H ₁₀ O	0.948	1423	4.0
Decane (46)	C ₁₀ H ₂₂	0.730	1252	
1-Decene (27)	C ₁₀ H ₂₀	0.746	1235	4.0
n-Decylene (27)	C ₁₀ H ₂₀	0.746	1235	4.0
Diacetyl	C ₄ H ₆ O ₂	0.99	1236	4.6
Diamylamine	C ₁₀ H ₂₃ N		1256	3.9
1,2 Dibromo-ethane (47)	C ₂ H ₄ Br ₂	2.18	995	
trans-1,2-Dibromoethene(47)	C ₂ H ₂ Br ₂	2.231	935	
Dibutyl phthalate	C ₈ H ₂₂ O ₄		1408	
Dichloro-t-butyl alcohol	C ₄ H ₈ Cl ₂ O		1304	3.8
2,3 Dichlorodioxane	C ₂ H ₆ Cl ₂ O ₂		1391	3.7
Dichlorodifluoromethane (3) (Freon 12)	CCl ₂ F ₂	1.516 (-40°C)	774.1	4.24
1,2 Dichloro ethane (47)	C ₂ H ₄ Cl ₂	1.253	1193	
cis 1,2-Dichloro-Ethene(3,47)	C ₂ H ₂ Cl ₂	1.284	1061	
trans 1,2-Dichloro-ethene(3,47)	C ₂ H ₂ Cl ₂	1.257	1010	
Dichloro-fluoromethane (3) (Freon 21)	CHCl ₂ F	1.426 (0°C)	891	3.97
1-2-Dichlorohexafluoro cyclobutane (47)	C ₄ Cl ₂ F ₆	1.654	669	
1-3-Dichloro-isobutane	C ₄ H ₈ Cl ₂	1.14	1220	3.4
Dichloro methane (3)	CH ₂ Cl ₂	1.327	1070	3.94
1,1-Dichloro-1,2,2,2 tetra fluoroethane	CClF ₂ -CClF ₂	1.455	665.3	3.73
Diethyl ether	C ₄ H ₁₀ O	0.713	985	4.87
Diethylene glycol, monoethyl ether	C ₆ H ₁₄ O ₃	0.988	1458	

Substance	Form Index	Specific Gravity	Sound Speed m/sec.	v/°C - m/s/°C Δ
Diethylenimide oxide	C ₄ H ₉ NO	1.00	1442	3.8
1,2-bis(DiFluoramino) butane (43)	C ₄ H ₈ (NF ₂) ₂	1.216	1000	
1,2bis(DiFluoramino)- 2-methylpropane (43)	C ₄ H ₉ (NF ₂) ₂	1.213	900	
1,2bis(DiFluoramino) propane (43)	C ₃ H ₆ (NF ₂) ₂	1.265	960	
2,2bis(DiFluoramino) propane (43)	C ₃ H ₆ (NF ₂) ₂	1.254	890	
2,2-Dihydroxydiethyl ether	C ₄ H ₁₀ O ₃	1.116	1586	2.4
Dihydroxyethane	C ₂ H ₆ O ₂	1.113	1658	2.1
1,3-Dimethyl-benzene (46)	C ₈ H ₁₀	0.868 (15°C)	1343	
1,2-1.0Dimethyl-benzene(29,46)	C ₈ H ₁₀	0.897 (20°C)	1331.5	4.1
1,4-Dimethyl-benzene (46)	C ₈ H ₁₀		1334	
2,2-Dimethyl-butane (29,33)	C ₆ H ₁₄	0.649 (20°C)	1079	
Dimethyl ketone	C ₃ H ₆ O	0.791	1174	4.5
Dimethyl pentane (47)	C ₇ H ₁₆	0.674	1063	
Dimethyl phthalate	C ₈ H ₁₀ O ₄	1.2	1463	
Diiodo-methane	CH ₂ I ₂	3.235	980	
Dioxane	C ₄ H ₈ O ₂	1.033	1376	
Dodecane (23)	C ₁₂ H ₂₆	0.749	1279	3.85
1,2-Ethanediol	C ₂ H ₆ O ₂	1.113	1658	2.1
Ethanenitrile	C ₂ H ₃ N	0.783	1290	
Ethanoic anhydride (22)	(CH ₃ CO) ₂ O	1.082	1180	
Ethanol	C ₂ H ₆ O	0.789	1207	4.0
Ethanol amide	C ₂ H ₇ NO	1.018	1724	3.4
Ethoxyethane	C ₄ H ₁₀ O	0.713	985	4.87
Ethyl acetate (33)	C ₄ H ₈ O ₂	0.901	1085	4.4
Ethyl alcohol	C ₂ H ₆ O	0.789	1207	4.0
Ethyl benzene (46)	C ₈ H ₁₀	0.867(20°C)	1338	
Ethyl bromide (46)	C ₂ H ₅ Br	1.461 (20°C)	900	
Ethyl iodide (46)	C ₂ H ₅ I	1.950 (20°C)	876	
Ether	C ₄ H ₁₀ O	0.713	985	4.87
Ethyl ether	C ₄ H ₁₀ O	0.713	985	4.87
Ethylene bromide (47)	C ₂ H ₄ Br ₂	2.18	995	
Ethylene chloride (47)	C ₂ H ₄ Cl ₂	1.253	1193	
Ethylene glycol	C ₂ H ₆ O ₂	1.113	1658	2.1
50% Glycol/ 50% H ₂ O			1578	
d-Fenochone	C ₁₀ H ₁₆ O	0.947	1320	
d-2-Fenechanone	C ₁₀ H ₁₆ O	0.947	1320	
Fluorine	F	0.545 (-143°C)	403	11.31
Fluoro-benzene (46)	C ₆ H ₅ F	1.024 (20°C)	1189	
Formaldehyde, methyl ester	C ₂ H ₄ O ₂	0.974	1127	4.02
Formamide	CH ₃ NO	1.134 (20°C)	1622	2.2

Substance	Form Index	Specific Gravity	Sound Speed m/sec.	v/°C - m/s/°C Δ
Formic acid, amide	CH ₃ NO	1.134 (20°C)	1622	
Freon R12			774	
Furfural	C ₅ H ₄ O ₂	1.157	1444	
Furfuryl alcohol	C ₅ H ₆ O ₂	1.135	1450	3.4
Fural	C ₅ H ₄ O ₂	1.157	1444	3.7
2-Furaldehyde	C ₅ H ₄ O ₂	1.157	1444	3.7
2-Furancarboxaldehyde	C ₅ H ₄ O ₂	1.157	1444	3.7
2-Furyl-Methanol	C ₅ H ₆ O ₂	1.135	1450	3.4
Gallium	Ga	6.095	2870 (@30°C)	
Glycerin	C ₃ H ₈ O ₃	1.26	1904	2.2
Glycerol	C ₃ H ₈ O ₃	1.26	1904	2.2
Glycol	C ₂ H ₆ O ₂	1.113	1658	2.1
Helium (45)	He ₄	0.125(-268.8°C)	183	
Heptane (22,23)	C ₇ H ₁₆	0.684 (20°C)	1131	4.25
n-Heptane (29,33)	C ₇ H ₁₆	0.684 (20°C)	1180	4.0
Hexachloro-Cyclopentadiene(47)	C ₅ Cl ₆	1.7180	1150	
Hexadecane (23)	C ₁₆ H ₃₄	0.773 (20°C)	1338	3.71
Hexalin	C ₆ H ₁₂ O	0.962	1454	3.6
Hexane (16,22,23)	C ₆ H ₁₄	0.659	1112	2.71
n-Hexane (29,33)	C ₆ H ₁₄	0.649 (20°C)	1079	4.53
2,5-Hexanedione	C ₆ H ₁₀ O ₂	0.729	1399	3.6
n-Hexanol	C ₆ H ₁₄ O	0.819	1300	3.8
Hexahydrobenzene (15)	C ₆ H ₁₂	0.779	1248	5.41
Hexahydrophenol	C ₆ H ₁₂ O	0.962	1454	3.6
Hexamethylene (15)	C ₆ H ₁₂	0.779	1248	5.41
Hydrogen (45)	H ₂	0.071 (-256°C)	1187	
2-Hydroxy-toluene (46)	C ₇ H ₈ O	1.047 (20°C)	1541	
3-Hydroxy-toluene (46)	C ₇ H ₈ O	1.034 (20°C)	1500	
Iodo-benzene (46)	C ₆ H ₅ I	1.823	1114	
Iodo-ethane (46)	C ₂ H ₅ I	1.950 (20°C)	876	
Iodo-methane	CH ₃ I	2.28 (20°C)	978	
Isobutyl acetate (22)	C ₆ H ₁₂ O		1180	4.85
Isobutanol	C ₄ H ₁₀ O	0.81 (20°C)	1212	
Iso-Butane			1219.8	
Isopentane (36)	C ₅ H ₁₂	0.62 (20°C)	980	4.8
Isopropanol (46)	C ₃ H ₈ O	0.785 (20°C)	1170	
Isopropyl alcohol (46)	C ₃ H ₈ O	0.785 (20°C)	1170	
Kerosene		0.81	1324	3.6
Ketohexamethylene	C ₆ H ₁₀ O	0.948	1423	4.0
Lithium fluoride (42)	LiF		2485	1.29
Mercury (45)	Hg	13.594	1449	

Substance	Form Index	Specific Gravity	Sound Speed m/sec.	v/°C - m/s/°C Δ
Mesityloxyde	C ₆ H ₁₆ O	0.85	1310	
Methane (25,28,38,39)	CH ₄	0.162	405(-89.15°C)	17.5
Methanol (40,41)	CH ₄ O	0.791 (20°C)	1076	2.92
Methyl acetate	C ₃ H ₆ O ₂	0.934	1211	
o-Methylaniline (46)	C ₇ H ₉ N	0.999 (20°C)	1618	
4-Methylaniline (46)	C ₇ H ₉ N	0.966 (45°C)	1480	
Methyl alcohol (40,44)	CH ₄ O	0.791 (20°C)	1076	2.92
Methyl benzene (16,52)	C ₇ H ₈	0.867	1328	4.27
2-Methyl-butane (36)	C ₅ H ₁₂	0.62 (20°C)	980	
Methyl carbinol	C ₂ H ₆ O	0.789	1207	4.0
Methyl-chloroform (47)	C ₂ H ₃ Cl ₃	1.33	985	
Methyl-cyanide	C ₂ H ₃ N	0.783	1290	
3-Methyl cyclohexanol	C ₇ H ₁₄ O	0.92	1400	
Methylene chloride (3)	CH ₂ Cl ₂	1.327	1070	3.94
Methylene iodide	CH ₂ I ₂	3.235	980	
Methyl formate (22)	C ₂ H ₄ O ₂	0.974 (20°C)	1127	4.02
Methyl iodide	CH ₃ I	2.28 (20°C)	978	
2-Methylphenol (46)	C ₇ H ₈ O	1.047 (20°C)	1541	
3-Methylphenol (46)	C ₇ H ₈ O	1.034 (20°C)	1500	
Milk, homogenized			1548	
Morpholine	C ₄ H ₉ NO	1.00	1442	3.8
Naphtha		0.76	1225	
Natural Gas (37)		0.316 (-103°C)	753	
Neon (45)	Ne	1.207 (-246°C)	595	
Nitrobenzene (46)	C ₆ H ₅ NO ₂	1.204 (20°C)	1415	
Nitrogen (45)	N ₂	0.808 (-199°C)	962	
Nitromethane (43)	CH ₃ NO ₂	1.135	1300	4.0
Nonane (23)	C ₉ H ₂ O	0.718 (20°C)	1207	4.04
1-Nonene (27)	C ₉ H ₁₈	0.736 (20°C)	1207	4.0
Octane (23)	C ₈ H ₁₈	0.703	1172	4.14
n-Octane (29)	C ₈ H ₁₈	0.704 (20°C)	1212.5	3.50
1-Octene (27)	C ₈ H ₁₆	0.723 (20°C)	1175.5	4.10
Oil of Camphor Sassafrassy			1390	3.8
Oil, Car (SAE 20a.30)	1.74		870	
Oil, Castor	C ₁₁ H ₁₀ O ₁₀	0.969	1477	3.6
Oil, Diesel		0.80	1250	
Oil, Fuel AA gravity		0.99	1485	3.7
Oil (Lubricating X200)			1530	5019.9
Oil (Olive)		0.912	1431	2.75
Oil (Peanut)		0.936	1458	

Substance	Form Index	Specific Gravity	Sound Speed m/sec.	v/°C - m/s/°C Δ
Oil (Sperm)		0.88	1440	
Oil, 6			1509	
2,2-Oxydiethanol	C ₄ H ₁₀ O ₃	1.116	1586	2.4
Oxygen (45)	O ₂	1.155 (-186°C)	952	
Pentachloro-ethane (47)	C ₂ HCl ₅	1.687	1082	
Pentalin (47)	C ₂ HCl ₅	1.687	1082	
Pentane (36)	C ₅ H ₁₂	0.626 (20°C)	1020	
n-Pentane (47)	C ₅ H ₁₂	0.557	1006	
Perchlorocyclopentadiene(47)	C ₅ Cl ₆	1.718	1150	
Perchloro-ethylene (47)	C ₂ Cl ₄	1.632	1036	
Perfluoro-1-Hepten (47)	C ₇ F ₁₄	1.67	583	
Perfluoro-n-Hexane (47)	C ₆ F ₁₄	1.672	508	
Phene (29,40,41)	C ₆ H ₆	0.879	1306	4.65
β-Phenyl acrolein	C ₉ H ₈ O	1.112	1554	3.2
Phenylamine (41)	C ₆ H ₅ NO ₂	1.022	1639	4.0
Phenyl bromide (46)	C ₆ H ₅ Br	1.522	1170	
Phenyl chloride	C ₆ H ₅ Cl	1.106	1273	3.6
Phenyl iodide (46)	C ₆ H ₅ I	1.823	1114	
Phenyl methane (16,52)	C ₇ H ₈	0.867 (20°C)	1328	4.27
3-Phenyl propenal	C ₉ H ₈ O	1.112	1554	3.2
Phthalardione	C ₈ H ₄ O ₃		1125	
Phthalic acid, anhydride	C ₈ H ₄ O ₃		1125	
Phthalic anhydride	C ₈ H ₄ O ₃		1125	
Pimelic ketone	C ₆ H ₁₀ O	0.948	1423	4.0
Plexiglas, Lucite, Acrylic			2651	
Polyterpene Resin		0.77	1099.8	
Potassium bromide (42)	Kbr		1169	0.71
Potassium fluoride (42)	KF		1792	1.03
Potassium iodide (42)	KI		985	0.64
Potassium nitrate (48)	KNO ₃	1.859 (352°C)	1740.1	1.1
Propane (2,13)(-45 to -130°C)	C ₃ H ₈	0.585 (-45°C)	1003	5.7
1,2,3-Propanetriol	C ₃ H ₈ O ₃	1.26	1904	2.2
1-Propanol (46)	C ₃ H ₈ O	0.78 (20°C)	1222	
2-Propanol (46)	C ₃ H ₈ O	0.785 (20°C)	1170	
2-Propanone	C ₃ H ₆ O	0.791	1174	4.5
Propene (17,18,35)	C ₃ H ₆	0.563 (-13°C)	963	6.32
n-Propyl acetate (22)	C ₅ H ₁₀ O ₂	1280 (2°C)	4.63	
n-Propyl alcohol	C ₃ H ₈ O	0.78 (20°C)	1222	
Propylchloride (47)	C ₃ H ₇ Cl	0.892	1058	
Propylene (17,18,35)	C ₃ H ₆	0.563 (-13°C)	963	6.32

Substance	Form Index	Specific Gravity	Sound Speed m/sec.	v/°C - m/s/°C Δ
Pyridine	C ₆ H ₅ N	0.982	1415	4.1
Refrigerant 11 (3,4)	CCl ₃ F	1.49	828.3	3.56
Refrigerant 12 (3)	CCl ₂ F ₂	1.516 (-40°C)	774.1	4.24
Refrigerant 14 (14)	CF ₄	1.75 (-150°C)	875.24	6.61
Refrigerant 21 (3)	CHCl ₂ F	1.426 (0°C)	891	3.97
Refrigerant 22 (3)	CHClF ₂	1.491 (-69°C)	893.9	4.79
Refrigerant 113 (3)	CCl ₂ F-CClF ₂	1.563	783.7	3.44
Refrigerant 114 (3)	CClF ₂ -CClF ₂	1.455	665.3	3.73
Refrigerant 115 (3)	C ₂ ClF ₅		656.4	4.42
Refrigerant C318 (3)	C ₄ F ₈	1.62 (-20°C)	574	3.88
Selenium (8)	Se		1072	0.68
Silicone (30 cp)		0.993	990	
Sodium fluoride (42)	NaF	0.877	2082	1.32
Sodium nitrate (48)	NaNO ₃	1.884 (336°C)	1763.3	0.74
Sodium nitrite (48)	NaNO ₂	1.805 (292°C)	1876.8	
Solvesso 3		0.877	1370	3.7
Spirit of wine	C ₂ H ₆ O	0.789	1207	4.0
Sulphur (7,8,10)	S		1177	-1.13
Sulphuric acid (1)	H ₂ SO ₄	1.841	1257.6	1.43
Tellurium (7)	Te		991	0.73
1,1,2,2-Tetrabromo-ethane(47)	C ₂ H ₂ Br ₄	2.966120	1027	
1,1,2,2-Tetrachloro-ethane(67)	C ₂ H ₂ Cl ₄	1.595	1147	
Tetrachloroethane (46)	C ₂ H ₂ Cl ₄	1.553 (20°C)	1170	
Tetrachloro-ethene (47)	C ₂ Cl ₄	1.632	1036	
Tetrachloro-methane (33,47)	CCl ₄	1.595 (20°C)	926	
Tetradecane (46)	C ₁₄ H ₃₀	0.763 (20°C)	1331	
Tetraethylene glycol	C ₈ H ₁₈ O ₅	1.123	1586/5203.4	3.0
Tetrafluoro-methane (14) (Freon 14)	CF ₄	1.75 (-150°C)	875.24	6.61
Tetrahydro-1,4-isoxazine	C ₄ H ₉ NO		1442	3.8
Toluene (16,52)	C ₇ H ₈	0.867 (20°C)	1328	4.27
o-Toluidine (46)	C ₇ H ₉ N	0.999 (20°C)	1618	
p-Toluidine (46)	C ₇ H ₉ N	0.966 (45°C)	1480	
Toluol	C ₇ H ₈	0.866	1308	4.2
Tribromo-methane (46,47)	CHBr ₃	2.89 (20°C)	918	
1,1,1-Trichloro-ethane (47)	C ₂ H ₃ Cl ₃	1.33	985	
Trichloro-ethene (47)	C ₂ HCl ₃	1.464	1028	
Trichloro-fluoromethane (3) (Freon 11)	CCl ₃ F	1.49	828.3	3.56
Trichloro-methane (47)	CHCl ₃	1.489	979	3.4
1,1,2-Trichloro-1,2,2-Trifluoro-Ethane	CCl ₂ F-CClF ₂	1.563	783.7	
Triethyl-amine (33)	C ₆ H ₁₅ N	0.726	1123	4.47
Triethylene glycol	C ₆ H ₁₄ O ₄	1.123	1608	3.8

Substance	Form Index	Specific Gravity	Sound Speed m/sec.	v/°C - m/s/°C Δ
1,1,1-Trifluoro-2-Chloro-2-Bromo-Ethane	C ₂ HClBrF ₃	1.869	693	
1,2,2-Trifluorotrichloro- ethane (Freon 113)	CCl ₂ F-CClF ₂	1.563	783.7	3.44
d-1,3,3-Trimethylnor- camphor	C ₁₀ H ₁₆ O	0.947	1320	
Trinitrotoluene (43)	C ₇ H ₅ (NO ₂) ₃	1.64	1610	
Turpentine		0.88	1255	
Unisis 800		0.87	1346	
Water, distilled (49,50)	H ₂ O	0.996	1498	-2.4
Water, heavy	D ² O		1400	
Water, sea		1.025	1531	-2.4
Wood Alcohol (40,41)	CH ₄ O	0.791 (20°C)	1076	2.92
Xenon (45)	Xe		630	
m-Xylene (46)	C ₈ H ₁₀	0.868 (15°C)	1343	
o-Xylene (29,46)	C ₈ H ₁₀	0.897 (20°C)	1331.5	4.1
p-Xylene (46)	C ₈ H ₁₀		1334	
Xylene hexafluoride	C ₈ H ₄ F ₆	1.37	879	
Zinc (7)	Zn		3298	

APPENDIX E – Speed of Sound of Water Relative to Temperature

Sonic Velocity Relative to Temperature of Pure Water								
Temp °F	Temp °C	Velocity ft/s	Temp °F	Temp °C	Velocity ft/s	Temp °F	Temp °C	Velocity ft/s
0.0	-17.8	4240	100.0	37.8	5003	200.0	93.3	5080
2.0	-16.7	4267	102.0	38.9	5010	202.0	94.4	5077
4.0	-15.6	4293	104.0	40.0	5016	204.0	95.6	5075
6.0	-14.4	4319	106.0	41.1	5022	206.0	96.7	5077
8.0	-13.3	4344	108.0	42.2	5028	208.0	97.8	5069
10.0	-12.2	4368	110.0	43.3	5033	210.0	98.9	5066
12.0	11.0	4392	112.0	44.4	5038	212.0	100.0	5063
14.0	10.0	4416	114.0	45.6	5043	214.0	101.1	5059
16.0	-8.9	4438	116.0	46.7	5048	216.0	102.2	5056
18.0	-7.8	4460	118.0	47.8	5052	218.0	103.3	5052
20.0	-6.7	4482	120.0	48.9	5057	220.0	104.4	5049
22.0	-5.6	4503	122.0	50.0	5061	222.0	105.6	5045
24.0	-4.4	4524	124.0	51.1	5065	224.0	106.7	5041
26.8	-3.3	4544	126.0	52.2	5068	226.0	107.8	5037
28.0	-2.2	4563	128.0	53.3	5072	228.0	108.9	5033
30.0	-1.1	4582	130.0	54.4	5075	230.0	110.0	5029
32.0	0.0	4601	132.0	55.6	5078	232.0	111.1	5024
34.0	1.1	4619	134.0	56.7	5081	234.0	112.2	5020
36.0	2.2	4637	136.0	57.8	5084	236.0	113.3	5015
38.0	3.3	4654	138.0	58.9	5086	238.0	114.4	5011
40.0	4.4	4671	140.0	60.0	5089	240.0	115.6	5006
42.0	5.6	4687	142.0	61.1	5091	242.0	116.7	5001
44.0	6.7	4703	144.0	62.2	5093	244.0	117.8	4996
46.0	7.8	4719	146.0	63.3	5094	246.0	118.9	4991
48.0	8.9	4734	148.0	64.4	5096	248.0	120.0	4986
50.0	10.0	4748	150.0	65.6	5097	250.0	121.1	4981
52.0	11.1	4763	152.0	66.7	5098	260.0	126.7	4944
54.0	12.2	4776	154.0	67.8	5099	270.0	132.2	4911
56.0	13.3	4790	156.0	68.9	5100	280.0	137.8	4879
58.0	14.4	4803	158.0	70.0	5101	290.0	143.3	4843
60.0	15.56	4816	160.0	71.1	5102	300.0	148.9	4806
62.0	16.7	4828	162.0	72.2	5102	310.0	154.4	4767
64.0	17.9	4840	164.0	73.3	5102	320.0	160.0	4724
66.0	18.9	4852	166.0	74.4	5102	330.0	165.6	4678
68.0	20.0	4863	168.0	75.6	5102	340.0	171.1	4633
70.0	21.1	4874	170.0	76.7	5102	350.0	176.7	4587
72.0	22.2	4885	172.0	77.8	5101	360.0	182.2	4537
74.0	23.3	4895	174.0	78.9	5101	370.0	187.8	4488
76.0	24.4	4905	176.0	80.0	5100	380.0	193.3	4439
78.0	25.6	4915	178.0	81.1	5099	390.0	198.9	4386
80.0	26.7	4925	180.0	82.2	5098	400.0	204.4	4331
82.0	27.8	4934	182.0	83.3	5097	410.0	210.0	4272
84.0	28.9	4943	184.0	84.4	5096	420.0	215.6	4209
86.0	30.0	4951	186.0	85.6	5094	430.0	221.1	4147
88.0	31.1	4959	188.0	86.7	5093	440.0	226.7	4081
90.0	32.2	4967	190.0	87.8	5091	450.0	232.2	4003
92.0	33.3	4975	192.0	88.9	5089	460.0	237.8	3937
94.0	34.4	4983	194.0	90.0	5087	470.0	243.3	3871
96.0	35.6	4990	196.0	91.1	5085	480.0	248.9	3806
98.0	36.7	4997	198.0	92.2	5082	490.0	254.4	3740

Sonic Velocity Relative to Temperature of Pure Water								
Temp °F	Temp °C	Velocity m/s	Temp °F	Temp °C	Velocity m/s	Temp °F	Temp °C	Velocity m/s
0.0	-17.8	1292.45	100.0	37.8	1525.03	200.0	93.3	1548.38
2.0	-16.7	1300.64	102.0	38.9	1526.99	202.0	94.4	1547.60
4.0	-15.6	1308.63	104.0	40.0	1528.86	204.0	95.6	1546.78
6.0	-14.4	1316.44	106.0	41.1	1530.67	206.0	96.7	1547.60
8.0	-13.3	1324.06	108.0	42.2	1532.4	208.0	97.8	1545.02
10.0	-12.2	1331.50	110.0	43.3	1534.06	210.0	98.9	1544.08
12.0	11.0	1338.77	112.0	44.4	1535.64	212.0	100.0	1543.11
14.0	10.0	1345.86	114.0	45.6	1537.16	214.0	101.1	1542.10
16.0	-8.9	1352.78	116.0	46.7	1538.61	216.0	102.2	1541.05
18.0	-7.8	1359.53	118.0	47.8	1539.99	218.0	103.3	1539.97
20.0	-6.7	1366.12	120.0	48.9	1541.30	220.0	104.4	1538.85
22.0	-5.6	1372.55	122.0	50.0	1542.55	222.0	105.6	1537.70
24.0	-4.4	1378.82	124.0	51.1	1543.74	224.0	106.7	1536.51
26.8	-3.3	1384.94	126.0	52.2	1544.86	226.0	107.8	1535.29
28.0	-2.2	1390.90	128.0	53.3	1545.91	228.0	108.9	1534.03
30.0	-1.1	1396.72	130.0	54.4	1546.91	230.0	110.0	1532.74
32.0	0.0	1402.39	132.0	55.6	1547.84	232.0	111.1	1531.42
34.0	1.1	1407.91	134.0	56.7	1548.72	234.0	112.2	1530.06
36.0	2.2	1413.30	136.0	57.8	1549.53	236.0	113.3	1528.67
38.0	3.3	1418.55	138.0	58.9	1550.29	238.0	114.4	1527.26
40.0	4.4	1423.66	140.0	60.0	1550.99	240.0	115.6	1525.81
42.0	5.6	1428.64	142.0	61.1	1551.63	242.0	116.7	1524.33
44.0	6.7	1433.48	144.0	62.2	1552.21	244.0	117.8	1522.83
46.0	7.8	1438.20	146.0	63.3	1552.74	246.0	118.9	1521.29
48.0	8.9	1442.80	148.0	64.4	1553.22	248.0	120.0	1519.73
50.0	10.0	1447.27	150.0	65.6	1553.64	250.0	121.1	1518.14
52.0	11.1	1451.62	152.0	66.7	1554.01	260.0	126.7	1507.00
54.0	12.2	1455.85	154.0	67.8	1554.32	270.0	132.2	1497.00
56.0	13.3	1459.97	156.0	68.9	1554.59	280.0	137.8	1487.00
58.0	14.4	1463.97	158.0	70.0	1554.80	290.0	143.3	1476.00
60.0	15.56	1467.86	160.0	71.1	1554.98	300.0	148.9	1465.00
62.0	16.7	1471.64	162.0	72.2	1555.07	310.0	154.4	1453.00
64.0	17.9	1475.31	164.0	73.3	1555.13	320.0	160.0	1440.00
66.0	18.9	1478.88	166.0	74.4	1555.15	330.0	165.6	1426.00
68.0	20.0	1482.34	168.0	75.6	1555.11	340.0	171.1	1412.00
70.0	21.1	1485.70	170.0	76.7	1555.03	350.0	176.7	1398.00
72.0	22.2	1488.96	172.0	77.8	1554.90	360.0	182.2	1383.00
74.0	23.3	1492.13	174.0	78.9	1554.72	370.0	187.8	1368.00
76.0	24.4	1495.19	176.0	80.0	1554.49	380.0	193.3	1353.00
78.0	25.6	1498.16	178.0	81.1	1554.22	390.0	198.9	1337.00
80.0	26.7	1501.04	180.0	82.2	1553.91	400.0	204.4	1320.00
82.0	27.8	1503.82	182.0	83.3	1553.55	410.0	210.0	1302.00
84.0	28.9	1506.52	184.0	84.4	1553.14	420.0	215.6	1283.00
86.0	30.0	1509.13	186.0	85.6	1552.70	430.0	221.1	1264.00
88.0	31.1	1511.65	188.0	86.7	1552.21	440.0	226.7	1244.00
90.0	32.2	1514.08	190.0	87.8	1551.67	450.0	232.2	1220.00
92.0	33.3	1516.44	192.0	88.9	1551.10	460.0	237.8	1200.00
94.0	34.4	1518.70	194.0	90.0	1550.48	470.0	243.3	1180.00
96.0	35.6	1520.89	196.0	91.1	1549.82	480.0	248.9	1160.00
98.0	36.7	1523.00	198.0	92.2	1549.12	490.0	254.4	1140.00



www.pulsarmeasurement.com
service@pulsarmeasurement.com

*Copyright © 2020 Pulsar Measurement Ltd.
Registered Address: 1 Chamberlain Square CS, Birmingham B3 3AX
Registered No.: 3345604 England & Wales
Rev 3.0*