

# SludgeFinder 2

**Instruction Manual**





## SludgeFinder 2 (SIXTH EDITION REV 5)

March 2024

Part Number M-920-0-006-5P

### **COPYRIGHT**

© Pulsar Measurement, 2009 -24. All rights reserved. No part of this publication may be reproduced, transmitted, transcribed, stored in a retrieval system, or translated into any language in any form without the written permission of Pulsar Measurement.

### **WARRANTY AND LIABILITY**

Pulsar Measurement guarantee for a period of 2 years from the date of delivery that it will either exchange or repair any part of this product returned to Pulsar Measurement if it is found to be defective in material or workmanship, subject to the defect not being due to unfair wear and tear, misuse, modification or alteration, accident, misapplication, or negligence. **Note: For a VT10 or ST10 transducer the period of time is 1 year from date of delivery.**

### **DISCLAIMER**

Pulsar Measurement neither gives nor implies any process guarantee for this product and shall have no liability in respect of any loss, injury or damage whatsoever arising out of the application or use of any product or circuit described herein.

Every effort has been made to ensure accuracy of this documentation, but Pulsar Measurement cannot be held liable for any errors.

Pulsar Measurement operates a policy of constant development and improvement and reserves the right to amend technical details, as necessary.

The SludgeFinder 2 shown on the cover of this manual is used for illustrative purposes only and may not be representative of the actual SludgeFinder 2 supplied.

### **CONTACT**

For technical support, please contact:

Europe: [supporteurope@pulsarmeasurement.com](mailto:supporteurope@pulsarmeasurement.com)

Outside Europe: [supportnorthamerica@pulsarmeasurement.com](mailto:supportnorthamerica@pulsarmeasurement.com)

If you have any comments or suggestions about this product, please contact:

Europe: [europe@pulsarmeasurement.com](mailto:europe@pulsarmeasurement.com)

Outside Europe: [northamerica@pulsarmeasurement.com](mailto:northamerica@pulsarmeasurement.com)

Pulsar Measurement website: [www.pulsarmeasurement.com](http://www.pulsarmeasurement.com)

#### **United States**

11451 Belcher Road South  
Largo,  
FL 33773  
888-473-9546

#### **Canada**

16456 Sixsmith Drive  
Long Sault, Ont.  
K0C 1P0  
855-300-9151

#### **United Kingdom**

Cardinal Building, Enigma  
Commercial Centre  
Sandy's Road, Malvern  
WR14 1JJ  
00 44 (0)1684 891371

## CONTENTS

Chapter 1: Start Here.....	8
About this Manual .....	8
About the SludgeFinder 2.....	9
Applications.....	10
Functional Description .....	11
Product Specification.....	12
EU Certificate of Conformity.....	14
Chapter 2 Installation.....	15
Unpacking .....	15
Power Supply Requirements.....	15
Location .....	16
Dimensions .....	17
Wall Mount.....	17
VT10 (Sludge) Transducer.....	19
ST10 (Sludge) Transducer .....	20
Terminal connection details.....	21
Terminal Connections.....	22
dB (Air) Transducer.....	23
ATEX .....	23
VT & ST (Sludge) Transducer.....	25
Wall mount Enclosure .....	26
Preparation for Operation .....	28
Maintenance .....	28
VT & ST (Sludge)Transducer Maintenance .....	28
Transducer Installation Options .....	31
Transceiver Mounting.....	38
Chapter 3 Pulsar Radio Telemetry System.....	41
Verifying Communications .....	45
Radio Telemetry Features .....	47
Pulsar Non-Integrated Point – Point Radio Telemetry.....	47

Receiver and Transmitter Dimensional Details.....	48
Gateway and Node wiring details .....	50
Analogue and Digital I/O .....	51
Installation Tips .....	52
Bridge Integrator-Radio Schematic .....	55
Specifications.....	56
How To Use Your SludgeFinder 2 .....	57
Operating the Controls.....	57
Run Mode.....	58
Program Mode.....	61
How to Access Program Mode.....	61
Hot Keys.....	63
Menu Keys .....	64
Numeric Keys.....	65
Using the Menu System .....	66
Directly Editing Parameters.....	67
Test Mode .....	68
Using the Serial Interface.....	69
Parameter Defaults.....	71
Chapter 4 Programming Guide.....	72
Measurements needed for Interface monitoring.....	72
Example 1: Primary Settlement Sludge Interface monitoring.....	73
Example 2: Level Monitoring with High and Low Alarms on Point 2 .....	75
Example 3: Using a Single Viper Transducer to Measure 2 Different Interface Levels. ....	78
Example 4: Setting the Unit to Alarm on Hi-Floc Levels.....	79
High Floc Alarm .....	79
Chapter 6 Menu System and Parameter Guide.....	81
Top Level Menu .....	81
Application Menu.....	81

Relays Menu .....	83
Floc Alarm Menu .....	84
Data Logs Menu .....	85
Display Menu .....	86
mA Output Menu .....	87
Compensation Menu .....	88
Stability Menu .....	88
Echo Processing Menu .....	89
System Menu .....	90
Device Comm Menu .....	92
Test Menu .....	93
Chapter 7 Parameter Listing and Description .....	94
Application Parameters.....	94
Global.....	97
Relay Parameters.....	98
Alarms.....	100
Control.....	103
Miscellaneous .....	105
Common Parameters.....	106
Floc Alarm Parameters .....	107
Service Interval Alarm Parameters.....	108
Data Log Parameters .....	108
Display Parameters.....	109
Failsafe.....	110
mA Out 1 / mA Out 2 Parameters .....	111
Setpoint.....	112
Compensation Parameters .....	114
Offset.....	114
Temperature.....	114
Stability Parameters .....	115
Damping .....	115

Filters.....	115
Echo Processing Parameters.....	116
Transducer 1 Status.....	116
Transducer 2 Status.....	117
System Parameters.....	118
Passcode.....	118
Backup.....	118
System Information.....	119
Date & Time.....	120
LED Colour.....	120
Watchdog.....	121
Daylight Saving Time.....	122
Device Comm. ....	126
RS232 Set Up.....	126
RS 485 Set Up.....	126
Test Parameters.....	127
Simulation.....	127
Hardware.....	128
Chapter 8 Troubleshooting.....	130
Chapter 9 Disposal.....	131
Notes.....	132

## CHAPTER 1: START HERE...

Congratulations on your purchase of a Pulsar Sludge Finder 2. This quality system has been developed over many years and represents the latest in high technology ultrasonic sludge monitoring.

It has been designed to give you years of trouble free performance, and a few minutes spent reading this operating manual will ensure that your installation is as simple as possible

### *About this Manual*

**It is important that this manual is referred to for correct installation and operation.** There are various parts of the manual that offer additional help or information as shown.

### *Tips*



**TIP: Look for this icon throughout your Pulsar Measurement manual to find helpful information and answers to frequently asked questions.**

### *Additional Information*

#### **Additional Information**

At various parts of the manual, you will find sections like this that explain specific things in more detail.

### *References*

#### **— See Also**

References to other parts of the manual.



## About the SludgeFinder 2



The single Sludge Finder 2 unit provides dual point level sensing in liquids and/or air. It is easily installed, with conduit entry on the unit via 5 x 20mm Knockouts and 1 x 16mm knockout.

Outstanding stability, accuracy, and repeatability. Sophisticated algorithms for echo extraction utilizing powerful Digital Signal Processing (DSP) microprocessors.

The system has superior performance based on current leading-edge technology and modern design procedures.

Two independent transducer channels with the option of combining submersible and air transducers.

Two fully adjustable 4–20 mA outputs, six fully programmable SPDT status relays.

RS232 and RS485 communications ports for multiple unit installations. Radio communications for remote 4–20mA Indication (optional).

All these features and more plus the ease of programming, make this instrument the number one choice for interface level measurement in liquids.

## ***Applications***

Sludge Finder 2 is designed to monitor the levels of materials in various processes and to regulate the control loops, start and stop motors, and initiate events based on measured process conditions.

Some applications for the units are listed below:

- Water & Wastewater Treatment Clarifiers
- Water & Wastewater Gravity & DAF Thickeners
- Raw Water Clarifiers
- Sumps, lagoons, settling ponds.
- Industrial Process Thickeners
- Salt Brine Tanks
- Material Inventory Tanks
- Process Thickeners
- Dewatering/Hydro Bins
- Pyrite Holding/Transfer Tanks
- FGD Thickeners
- Surge & Settling Tanks
- Oil/Water separators
- SBR Tanks

### **Functional Description**

Sludge Finder 2 sends a transmit pulse to the transducer, which then emits a high frequency ultrasonic sound wave perpendicular to the transducer face, the returned echo is received by the Sludge Finder 2. The time taken to receive the echo is measured and the distance from the transducer face to the sludge interface is calculated.

The relays can be programmed to activate alarms, pump starters, or other control equipment. There is an isolated 4-20 mA output for each of two transducer channels that can be connected to a recorder or PLC to monitor the **sludge interface** independently from that shown on the display. Finally, there is an RS232 port, so that the Sludge Finder 2 can be operated remotely by a PC or other equipment to download/upload parameters or view real time echo traces.

Sludge Finder 2 can be programmed either by the built-in keypad, or by PC via the RS 232 Serial Interface. All parameters are stored in non-volatile memory, so are retained in the event of power interruption. A second backup copy of all parameters can also be retained in the Sludge Finder 2 memory, in case an alternative set of parameters needs to be stored.

Six user definable control relays with individual setpoints and intelligent performance logging software features ensure maximum control versatility.

The Pulsar Sludge Finder 2 ultrasonic sludge detector has been designed to provide maintenance-free fit and forget performance.

**Product Specification**

**PHYSICAL**

<b>Wall Mount outside Dimensions</b>	235 x 184 x 120mm (9.25 x 7.24 x 4.72")
<b>Weight</b>	Nominal 1 kg (2.2lbs)
<b>Enclosure Material/Description</b>	Polycarbonate, flame resistant to UL94-5V
<b>Cable entry detail</b>	10 cable entry knockouts, 1 x M16 underside, 5 x M20, 4 PG11 at rear.
<b>Transducer Cable Extensions</b>	3-conductor 20AWG screened
<b>dB series (Air)</b>	3,280 ft (1,000m)
<b>Maximum Separation</b>	

**ENVIRONMENTAL**

<b>IP Rating (Fascia)</b>	IP65, IP20 when open
<b>Altitude</b>	2000m maximum
<b>Max. &amp; min. temperature (electronics)</b>	-20 °C to +50 °C (-4°F to 122°F)
<b>Flammable atmosphere approval</b>	Safe area: compatible with approved dB transducers (see transducer spec' sheet)
<b>CE approval</b>	See EU Declaration of Conformity

**PERFORMANCE (WITH SLUDGE)**

<b>Accuracy</b>	0.25% of the measured range or 1.181" (30 mm) (whichever is greater)
<b>Resolution</b>	0.25% of the measured range or 0.394" (10 mm) (whichever is greater)
<b>Max. Range</b>	32.808ft (10m)
<b>Min. Range</b>	0.984ft (0.3m)
<b>Rate Response</b>	Fully adjustable

**OUTPUTS**

<b>Analogue Output</b>	2 off Isolated (to 150V floating) output of 4-20 mA or 0-20 mA into 1kΩ (user programmable and adjustable) 0.1% resolution.
<b>Digital Output</b>	Half Duplex RS232
<b>Volt free contacts, number, and rating</b>	6 form "C" (SPDT) rated at 5A at 115V AC
<b>Display</b>	192 x 128 pixel illuminated graphical display Fully programmable display options Integral keypad with menu navigation keys
<b>Radio Modem (optional)</b>	4 – 20mA using wireless exempt frequencies Maximum range 1640ft (500m) line of site
<b>Communication bus (optional)</b>	RS485 Modbus RTU/ASCII or Profibus DPV1 (slave device)

---

**PROGRAMMING**

<b>On-board programming</b>	By integral keypad
<b>PC programming</b>	Via RS232
<b>Programming security</b>	Via passcode (user selectable and adjustable)
<b>Programmed data integrity</b>	Via non-volatile RAM, plus backup

---

**SUPPLY**

<b>Power Supply</b>	Universal 100-240V ac 50-60 Hz, dc 22 - 28V 20W maximum power (typically 11W)
<b>Fuse</b>	2A Slow blow

---

**VIPER TRANSDUCER**

<b>Sensor body dimensions</b>	78 x 195mm (3.07 x 7.67in)
<b>Sensor Weight</b>	Nominal 1.5kg (3.3lbs)
<b>Sensor body material</b>	Valox 357. Wiper blade – Stainless steel
<b>Transducer cable extensions</b>	2 twisted pair 0.5mm <sup>2</sup> with overall screen
<b>Maximum separation</b>	200 m (656ft)
<b>Max and min temperature (electronics)</b>	-20 °C to +50 °C (-4°F to 122°F)
<b>IP Rating</b>	IP68
<b>Accuracy</b>	0.25% of the measured range or 1.81in (30 mm) (whichever is greater)
<b>Resolution</b>	0.25% of the measured range or 10 mm (whichever is greater)
<b>Max. range</b>	10m (32.8ft)
<b>Min. range</b>	0.3m (0.98ft)
<b>Min sludge density</b>	0.5% concentration

Pulsar Measurement operates a policy of constant development and improvement and reserve the right to amend technical details, as necessary.

**EU Certificate of Conformity**



**EU DECLARATION OF CONFORMITY**

**P U L S A R *Sludge Finder2***

This declaration of conformity is issued under the sole responsibility of the manufacturer

Relevant Directive(s)	2014/30/EU - EMC Directive and its amending directives. 2014/35/EU - Low Voltage Directive and its amending directives. 2011/65/EU - RoHS Directive and its amending directives.
Manufacturer's Name	Pulsar Process Measurement Ltd.
Manufacturer's Address	Cardinal Building, Enigma Business Commercial Centre, Sandy's Road, Malvern, Worcestershire, WR14 1JJ, UK.
Apparatus	Pulsar Sludge Finder2 Monitor, ST10 transducer, Viper transducer.
Type of Equipment	Measurement and control.
Standards Applied	EN 61010-1:2010+A1:2019 Safety requirements for electrical equipment for measurement, control, and laboratory use. EN 61326-1:2013 EMC, equipment class industrial.

Signed  Name: Tim Brown, electronics engineer. Pulsar Process Measurement Ltd.	Date: 18/2/2021 Rev 1.6
---	----------------------------

## CHAPTER 2 INSTALLATION

### *Unpacking*

#### **Important Information**

All shipping cartons should be opened carefully. When using a box cutter, do not plunge the blade deeply into the box, as it could potentially cut or scratch equipment components. Carefully remove equipment from each carton, checking it against the packing list before discarding any packing material. If there is any shortage or obvious shipping damage to the equipment, report it immediately to Pulsar Measurement.

### *Power Supply Requirements*

Sludge Finder 2 can operate from AC supply or from a DC battery. The **AC** is supplied via a universal 100-200VAC transformer. The **DC** is **22-28V**. In all cases the Sludge Finder 2 will typically consume 11W of power, with a maximum of 20W.

**Location**

The SludgeFinder 2 must be mounted in a non-hazardous (safe) area, and the transducer fitted in the hazardous area.

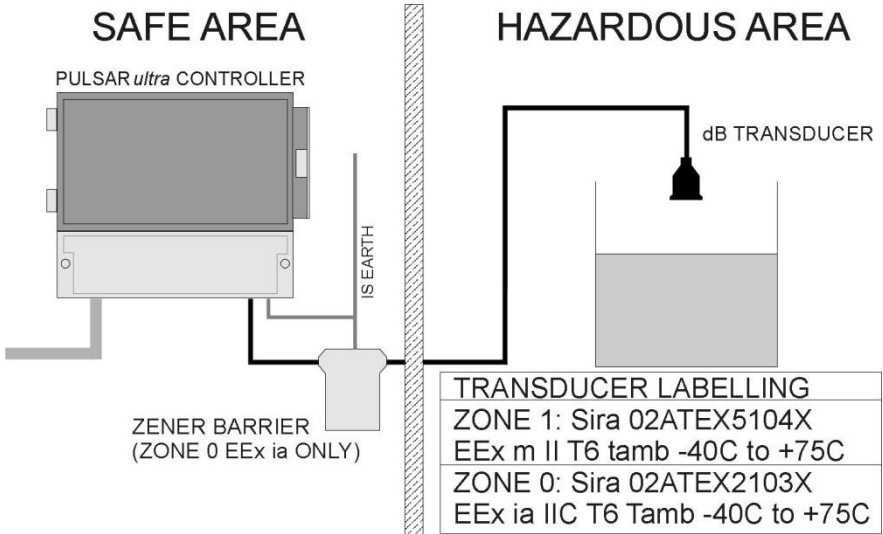

When choosing a location to mount the enclosure, bear in mind the following:

- Ensure that the SludgeFinder 2 is installed in a “Safe”, non-hazardous area.
- For a clear view of the LCD display, it is recommended that it is mounted at eye level.
- The mounting surface is to be vibration free.
- The ambient temperature is between -20°C and 50°C.
- There should be no high voltage cables or inverters nearby,

**Important Information**

All electronic products are susceptible to electrostatic shock, so follow proper grounding procedures during installation.



## Dimensions

### Wall Mount

The dimensions of the wall fixing holes are as shown below:

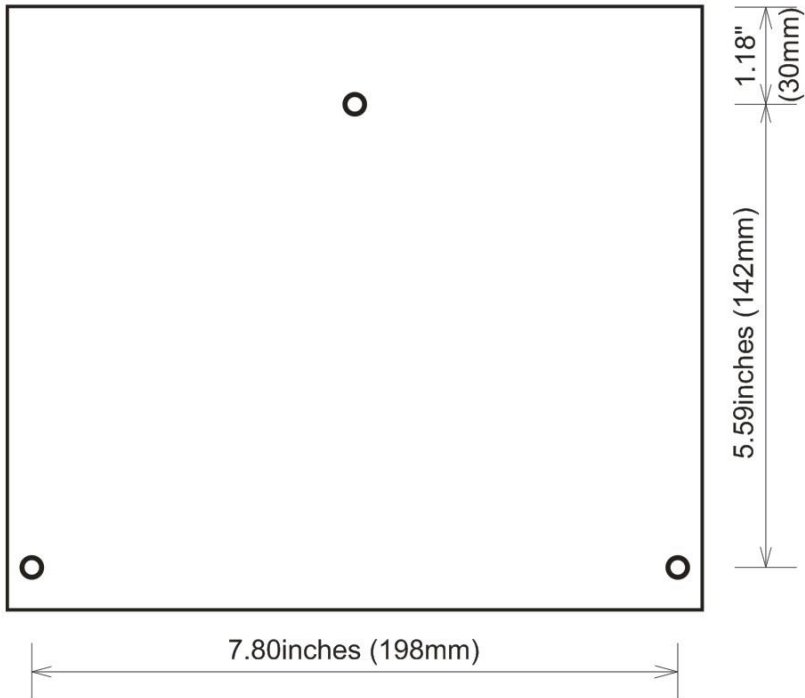

The Sludge Finder 2 should be mounted by drilling three holes suitable for size 8 screws (length to suit your application) and fixing the top screw in place. Hang the unit on this and fix the two remaining screws by removing the terminals access cover to access the pre-drilled holes.

The full dimensions of the enclosure are as shown below:

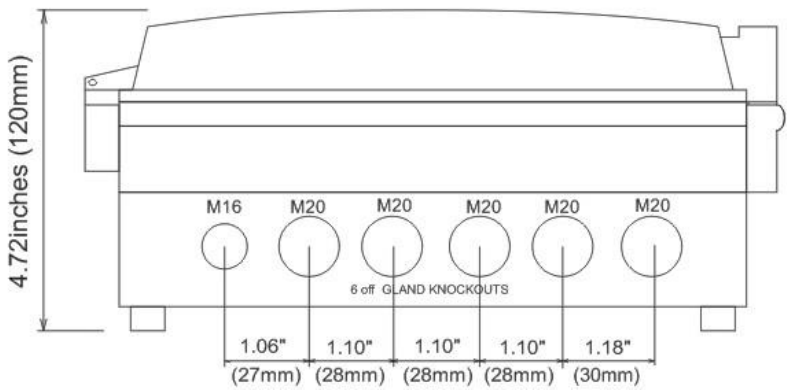
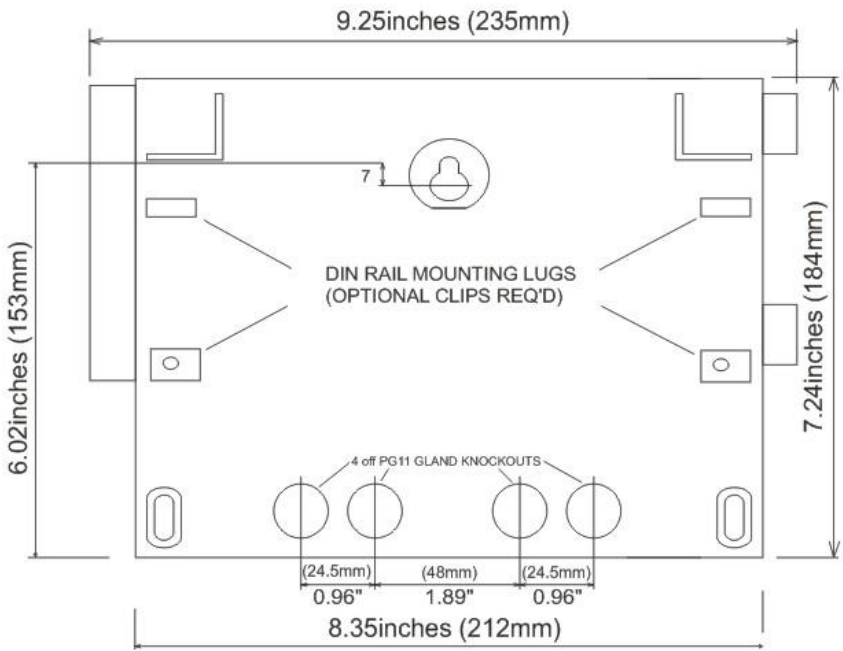

### Cable entry

There are 6 cable gland knockouts on the base of the Sludge Finder 2 (5 x M20, 1 x M16) and 4 on the rear (4 x PG11). Select which ones you wish to take out, and remove them by using a circular cutter, such as a tank cutter. Take care not to damage the circuit board inside whilst undertaking this. Do not use a hammer, as this may cause damage to the enclosure.

It is recommended that you use suitable cable glands to ensure that the ingress rating is maintained.

### VT10 (Sludge) Transducer

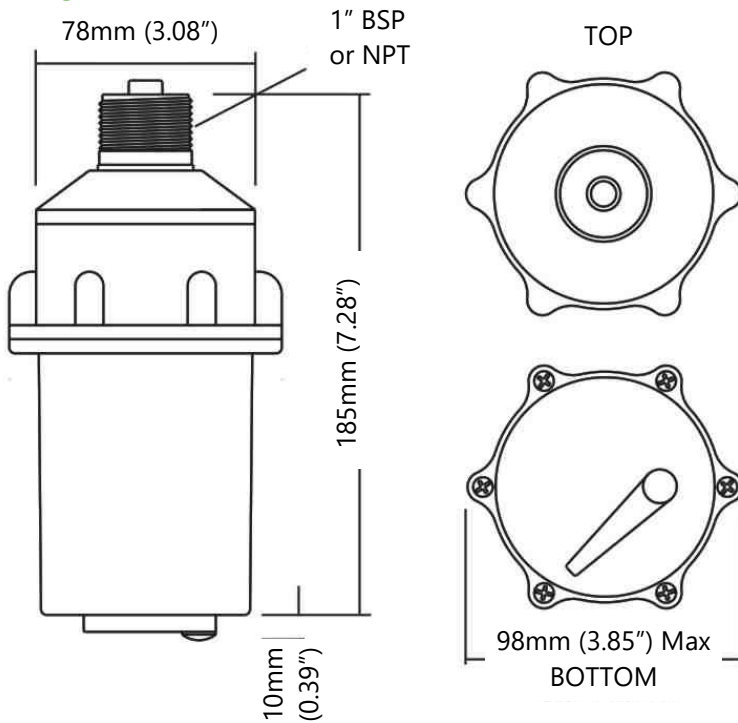

**MATERIAL: BLACK VALOX 357**

#### Important Information

Please note that the VT10 has a 1-year warranty period from the date of delivery from Pulsar, if an issue arises with the item, please contact your local Pulsar distributor, and return it to Pulsar within its warranty period.

**ST10 (Sludge) Transducer**

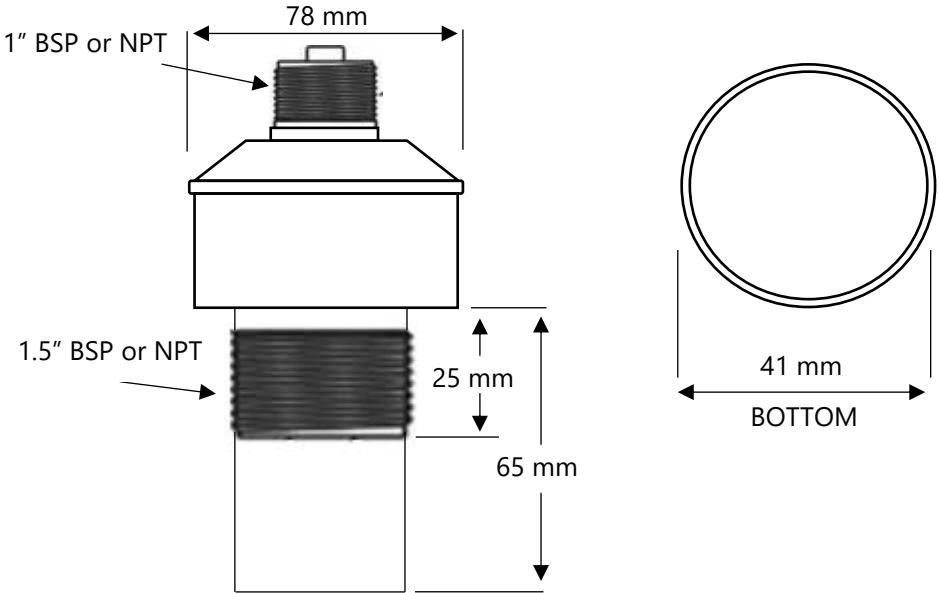

**Important Information**

Please note that the ST10 has a 1-year warranty period from the date of delivery from Pulsar, if an issue arises with the item, please contact your local Pulsar distributor, and return it to Pulsar within its warranty period.

**Terminal connection details**

The terminal strip is as detailed below. There is also a wiring diagram inside the terminal access cover as shown below:

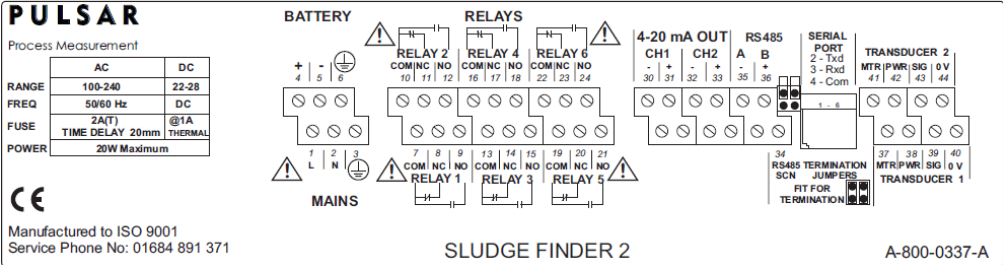

**Terminal Connections**

*Power*

Sludge Finder 2 can operate from mains AC and automatically from DC or battery backup in the event of power failure or can be operated permanently from DC or batteries.

Wire the transducer to the Sludge Finder 2’s transducer terminals as follows:

**VT & ST Sludge Transducers**

*Transducer 1*

**TERMINAL CONNECTION DETAILS**

	*Orange: Motor	Red: Power	White: Signal	Black: 0 Volts	Green: Screen
Terminal No.	37	38	39	40	40

*Transducer 2*

**TERMINAL CONNECTION DETAILS**

	*Orange: Motor	Red: Power	White: Signal	Black: 0 Volts	Green: Screen
Terminal No.	41	42	43	44	44

***\*There is no motor connection for the ST10, please connect the other cables for the ST10 as outlined in the tables above.***

**dB (Air) Transducer***Transducer 1***TERMINAL CONNECTION DETAILS**

	Not required	Red: Power	White: Signal	Black: 0 Volts	Green: Screen
Terminal No.	N/A	38	39	40	40

*Transducer 2***TERMINAL CONNECTION DETAILS**

	Not required	Red: Power	White: Signal	Black: 0 Volts	Green: Screen
Terminal No.	N/A	42	43	44	44

When installing a transducer in a hazardous area use an approved transducer, from the Pulsar dB range, suitable for the proposed application.

**ATEX**

For **EEx m (Zone 1)** applications a transducer certified to **Sira 02ATEX5104X** is used, and must be supplied via a 4000A breaking fuse, which is fitted as standard to the Sludge Finder 2 controller.

For **EEx ia (Zone 0)** a transducer certified to **Sira 02ATEX2103X** is used, which must be connected to the Sludge Finder 2 via an external Zener barrier.

See transducer label for certification details.

**Important Information**

Please note that if the output of the ultrasonic transducers used with the Sludge Finder 2 are capable of emitting sound pressure levels in excess of 85dBA (above a reference sound pressure level of 20µPA), then the Sludge Finder 2 must be located remote from the transducer such that a sound pressure level of 85dBA is not exceeded when standing at the Sludge Finder 2 in the operator's position.

### *Relay Outputs*

The six relays can be programmed for a variety of alarms or process control functions. The relay contacts are all rated at 5A at 115V AC. All connections should be such that the short circuit capacity of the circuits to which they are connected, is limited by fuses rated such that they do not exceed the relay rating.

### *Current Output*

This is an isolated (floating) mA output (to 150 V), of 4 - 20mA or 0 - 20mA, and the load should not exceed 500  $\Omega$ .

### *RS2323 Serial Interface*

If required, you can connect to the serial interface to operate your Sludge Finder 2 remotely.

#### **Important Information**

Never operate the Sludge Finder 2 with terminal access exposed.

An external switch or circuit breaker should be installed near to the Sludge Finder 2 to allow the supply to be removed during installation and maintenance. In installations where the relay contacts have mains power connected, there should be a means of isolating them from the Sludge Finder 2.

Interconnecting cables must be adequately insulated for IEC 664 Category II installations. Strip back 30 mm of the outer insulation of the cable. Strip 5 mm of insulation from the end of each conductor. Twist all exposed strands of the conductor together. Insert the stripped conductor into the terminal block as far as it will go and tighten the terminal block screw. Ensure that all strands are firmly clamped in the terminal block and that there is no excess bare conductor showing, and no stray strands.

#### **Important Information**

If the equipment is installed or used in a manner not specified in this manual, then the protection provided by the equipment may be impaired.



## **VT & ST (Sludge) Transducer**

### *Locating the Sludge Transducer*

- Position the transducer at a height within the tank such that it is fully submerged at all times that measurements are required, typically the face of the transducer should be **150mm** below the normal water level. **Liquid temperature compensation will only function correctly if the transducer is submerged at this level or below.**
- Ensure an unobstructed path between the transducer and the bottom of the tank. N.B. Rotating sub-surface rakes and scrapers, that pass beneath the transducer, do not interfere with normal operation.
- Select a location that minimizes the presence of gas bubbles, high flow and heavy solid concentration dynamics in the process liquid near or the transducer.
- Typical installation in a round clarifier or thickener is 1/3 to 2/3 the distance from the sidewall to the centre of the tank with transducer mounted from the walkway safety railing.
- Typical installation in a rectangular clarifier or thickener is along the length of the clarifier in the third of the tank nearest the sludge discharge sump.

### *Installing the Transducer*

- The transducer housing is designed to accept a 1" BSP or NPT female threaded coupler for pipe or conduit. Feed the integral transducer cable through the mounting pipe and tighten by hand until snug. **CAUTION: extreme over-tightening may crack the transducer housing.**
- Position the transducer such that it is 150mm below the water surface and the mounting pipe is perpendicular to the water surface. Secure the mounting pipe in place with clamps to ensure that it is rigid.
- Flexible arm transducer assemblies are available and are required where there is surface skimming equipment that passes the location of the transducer. Rotate the transducer mounting pipe so that the integral transducer shield contacts the skimmer arm squarely. Ensure that the transducer moves freely away from the passing skimmer equipment.
- Optional transducer mounting brackets are available to extend the mounting pipe away from its connection point at the handrail to provide clearance from obstructions.

- If desired, the transducer cable may be extended up to 200m. Install transducer cables in grounded metal conduit. Do not run-in cable trays or duct banks with variable frequency drives or other high voltage sources.
- Air (dB) transducers should be installed and connected in accordance with the installation instructions contained in the dB Transducer User Guide.

### **Wall mount Enclosure**

#### *Locating the Sludge Finder 2 unit*

- The unit may be located inside a building, or it may be field-mounted.
- Locate the unit so that the maximum cable length to any transducer does not exceed 200m.
- Avoid locating the processor near variable frequency drives or other high voltage equipment or cables.
- Ensure that the Sludge Finder 2 controller is installed in a "Safe", non-hazardous, area.
- For a clear view of the LCD display it is recommended that it is mounted at eye level.
- Ensure the mounting surface is vibration-free and the ambient temperature is between -20°C and 50°C.

#### *Installing the controller*

- Mount the unit at a convenient height for viewing the control panel and displays. Allow sufficient clearance around the unit for the door to swing fully open for instrument service.
- Secure to a wall or panel using the mounting holes. Alternatively, attach to a local handrail using the optional Integrator Mounting Assembly.

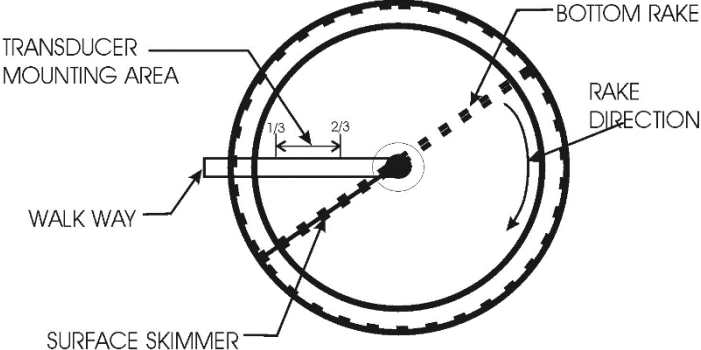

CIRCULAR CLARIFIER

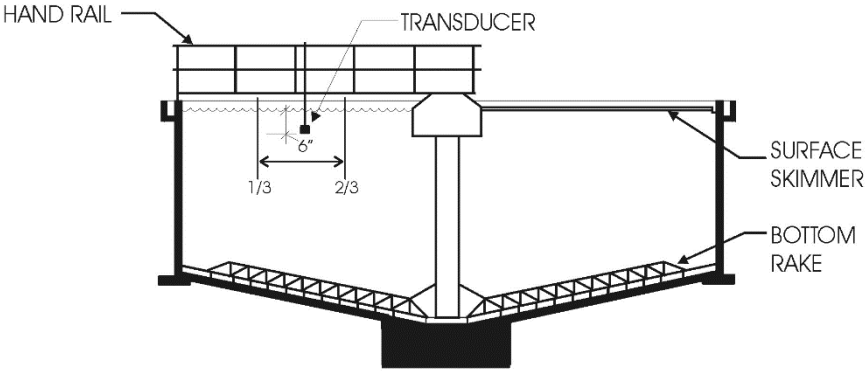

TYPICAL SECTION

TYPICAL ROUND CLARIFIER

### ***Preparation for Operation***

Before switching on, check the following:

- ✓ The Sludge Finder 2 is mounted correctly and is in a 'safe' area.
- ✓ The power supply is correctly installed.
- ✓ The relays are connected correctly.

### ***Maintenance***

There are no user serviceable parts inside Sludge Finder 2, except the mains fuse. If you experience any problems with the unit, then please contact Pulsar Measurement for advice.

To clean the equipment, wipe with a damp cloth. Do not use any solvents on the enclosure.

### ***VT & ST (Sludge)Transducer Maintenance.***

#### ***Procedure for the Removal of Transducers***

From time to time, it may be necessary to remove the transducer for cleaning or maintenance purposes, the following procedure is to ensure that this is done carefully with regard for the health and safety of the operator involved, and without damage to the transducer.

The transducer mounting bracket (option 1) is designed such that the transducer can be removed without any parts being available to fall into the application. Before attempting to remove the transducer for cleaning or maintenance, the power to the unit should be disconnected.

The correct PPE should be worn to ensure you do not come into direct contact with the wetted parts of the Sludge Finder 2 system, if in doubt contact your site Health and Safety Officer. To remove the transducer, loosen the retaining bolts on the end of the mounting brackets as shown in fig.1 and lift the transducer conduit assembly onto the walkway. The conduit is attached to the mounting assembly plate by means of a security chain so that it cannot be dropped and lost into the application.

The transducer can then be safely inspected for damage or material fouling and can be carefully cleaned with a damp cloth to remove any foreign debris. Care should be taken not to move the wiper by hand as any movement not under the power of the motor may damage the unit.

**IMPORTANT WARRANTY NOTICE:**



**THE ONE YEAR TRANSDUCER WARRANTY IS VOID IF THE WIPER BLADE IS ROTATED BY HAND. THIS IS DETRIMENTAL TO THE MOTOR GEAR DRIVE AND WILL DAMAGE THE UNIT.**

The wiper arm on the VT10 will move twice every 20 mins as a default setting, if the face of the transducer is dirty and you are unsure as to whether or not the wiper is cleaning then place the transducer such that the wiper movement will not foul on anything and use the appropriate function key (F5) to force a wipe (see note below).

### Important Information

The F5 function key will only initiate a wiper sweep on a VT transducer related to the currently viewed point and will only operate in run mode on the "Main" display. The function key will not initiate a wiper sweep if the dual point view is displayed.

If it is necessary to replace the transducer, the following procedure should be followed.

Disconnect the transducer wiring from the electronics as shown on page 15 and remove the transducer cable from the electronics enclosure.

The transducer is mounted onto the end of the conduit via its process fitting, this should be carefully unscrewed in an anticlockwise direction. Make sure the transducer is not dropped or knocked as this can damage the unit.

When replacing the transducer care must be taken not to over tighten the unit as this can result in the transducer 'ringing'. Hand tight is sufficient.

When the transducer is replaced into the application and the power re-applied the unit will re-initialise and after a short period of time depending on the process conditions show the correct blanket reading.

### *Transducer Installation Options*

1. Stainless steel mounting plate.

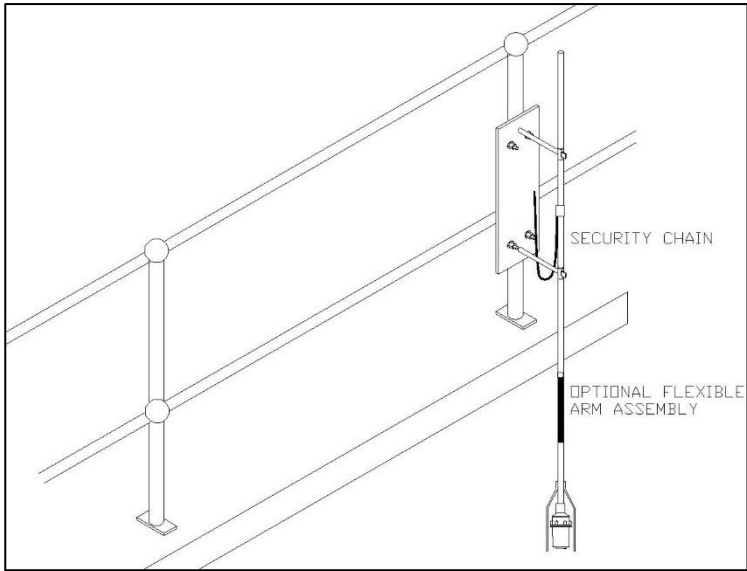

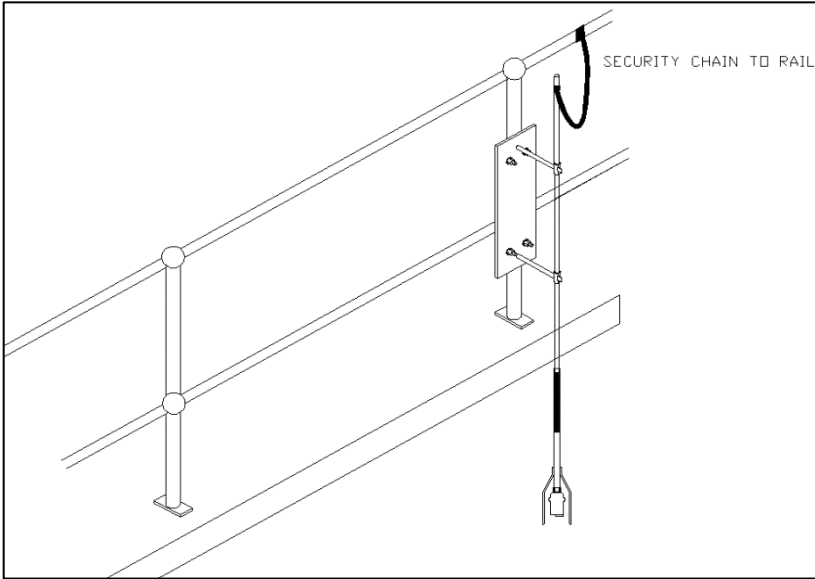

The mounting system shown above including the conduit is made from stainless steel.

The mounting plate is attached to the (normally galvanised) handrail via two hot dipped galvanised U-bolts, the U-bolts are then separated from the mounting plate via robust cast plastic spacers.

This system ensures that there are no problems with dissimilar metal reactions, and the entire mounting system should not suffer from oxidation/corrosion issues which can cause problems when performing maintenance.

The above system is also available with an optional 2.3m length of Stainless  $\frac{3}{4}$ " conduit, with other lengths being available on request. The conduit can be secured to the mounting bracket or the chain can be supplied welded to the conduit for the customer to attached at a suitable point.



Mounting Plate Dimensions

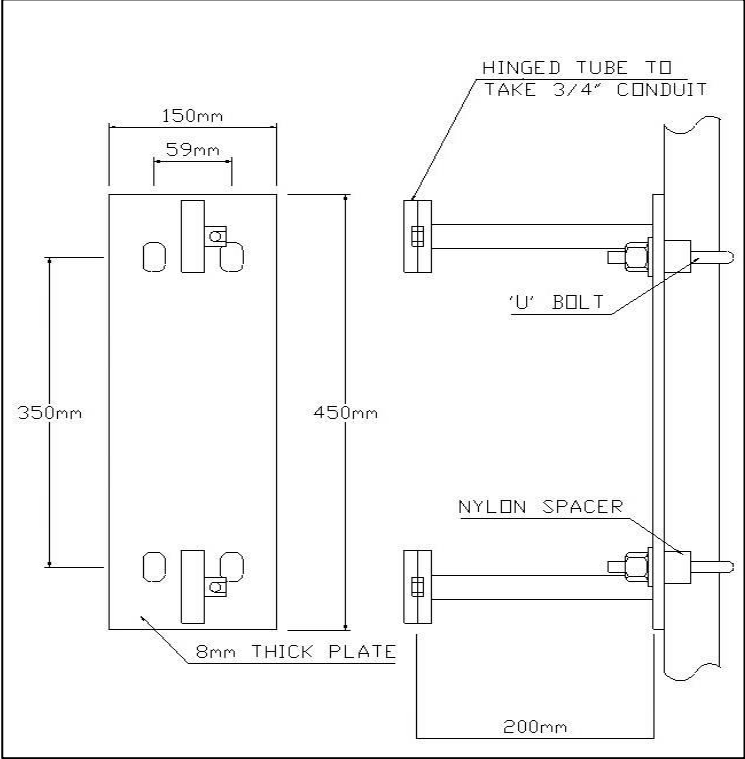

*Mounting Bracket (exploded view)*



**Note:** the two arms holding the hinged conduit retainers are welded to the mounting plate.

## **Part Numbers**

Stainless transducer mounting bracket assembly complete with security chain and 2.5m  $\frac{3}{4}$ " stainless conduit.

Part Number 9200A0007

Stainless transducer mounting bracket assembly without chain or conduit.

Part Number 9200A0008

Flexible Arm Assembly

Part Number 9200A0001

2. Budget Mounting Option.

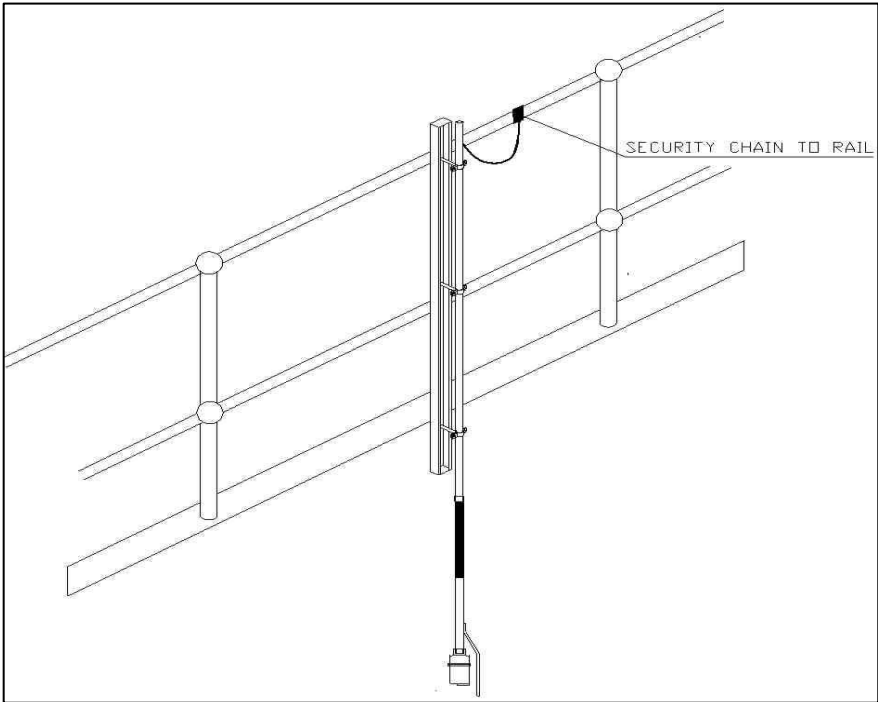

This mounting system has galvanised parts and is designed to be a budget option for transducer mounting.

In the picture shown above the security chain and flexible arm assembly are optional.

### Mounting option 2, arm assembly

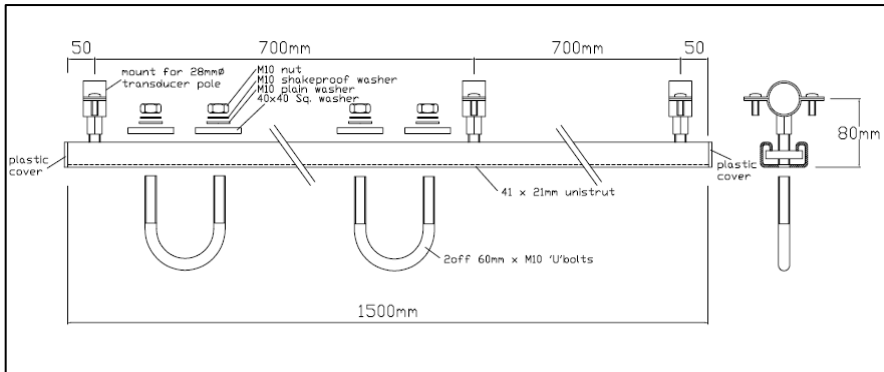

### Part Numbers

Budget galvanised transducer mounting bracket complete with security chain and 2.5m  $\frac{3}{4}$ " galvanized conduit.

Part Number 9200A0009

Budget galvanised transducer mounting bracket.

Part Number 9200A0010

Flexible Arm Assembly

Part Number 9200A0001

### **Transceiver Mounting**

The Sludge Finder 2 transceiver is mounted in an IP65 rated enclosure.

These enclosures are often situated out in the open on the walkways or bridges of settlement tanks and are therefore very exposed to the elements.

We offer a metal enclosure like the one below to ensure that, if required, the unit is not mounted in direct sunlight and is sheltered from any potential exposure to water ingress via precipitation or the application itself.



A steel enclosure with optional mounting plate and brackets is recommended as a suitable enclosure.

Dimensions: W x H x D: 400 mm x 400 mm x 200 mm are adequate.

Requirements: General protection of electrical and other equipment against impact and the ingress of dust and liquids.

### **Example Spec**

- Overall sheet steel construction.
- Epoxy powder coated to RAL7032.
- Earth points on enclosure body & door.
- IP55 protection as standard.
- Polyurethane gasket.

**Note:** Enclosure mounting equipment supplied and fitted by others to suit local site conditions.

### *Cabinet Mounting*

If the Sludge Finder 2 transceiver is mounted into the steel cabinet, Pulsar can offer the necessary metalwork to affix the cabinet to a bridge or walkway as seen below. This includes 2 x slotted galvanised steel rails and 4 x U-bolt fittings (customer specified diameter).

Any other required fittings in addition to the above must be purchased separately by the installer.

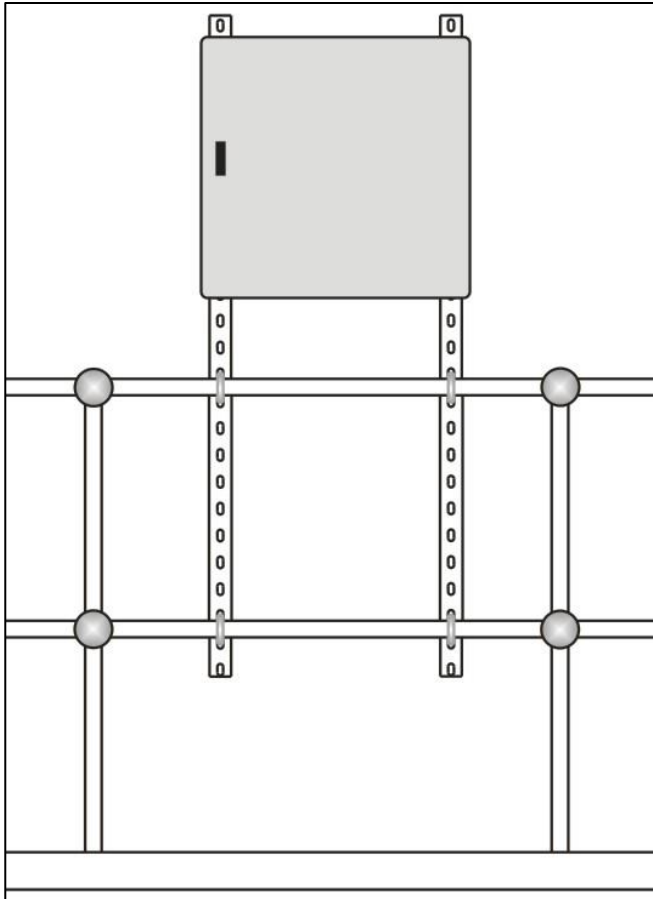

**Part Numbers for Cabinet Assembly.**

Sludge Finder 2 integrator enclosure complete with chassis plate and mounting bracket.

Part Number 9200A0004

Sludge Finder 2 integrator enclosure complete with 5 x cable glands installed, integrator fixed to the internally mounted chassis plate and mounting brackets.

Part Number 9200A0005

Handrail installation kit for Sludge Finder 2 enclosure. Includes 2 x 2m mounting rails and 4 x U-bolts (diameter to be customer specified)

Part Number 9200A0006



## CHAPTER 3 PULSAR RADIO TELEMETRY SYSTEM

Some Pulsar units may be fitted with an optional Radio Telemetry System. This system cannot be retro fitted and must be purchased at the time of ordering.

The system consists of a small transmitter board or 'Node' that is integrated into the SF2 housing and a receiver or 'Gateway' that is placed in a suitable location. The transmitter is pre-wired into the analogue output terminals and three of the digital outputs as shown below.

### *TRANSMITTER (node) WIRING*

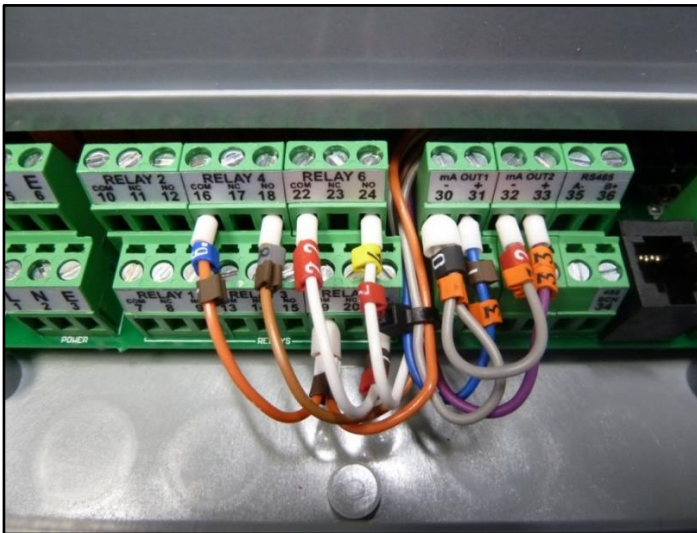

The transmitter unit has two analogue outputs and two digital outputs.

Channel 1 is mA OUT 1. Channel 2 is mA OUT 2.

Relay 4 is DIG OUT 1. Relays 5 and 6 are DIG OUT 2

The mA output will be set by the user in the Application section of the parameters to reflect the operational 4-20 mA output span of the instrument.

The Relays should be programmed as follows.

Relay 5 should be set to be a Loss of Echo alarm, Relay 6 should be set to be a Wiper fail. These outputs are wired in series to DIG 2 and are used to give a Failure Output.

Relay 4 can be programmed as a customer preference for Hi or Lo alarm output.

*RECEIVER (gateway) DX80*

The Receiver unit is shown below.



The Receiver unit needs to be supplied with 10-30vdc.

The Power Supply and output terminals are shown below.

## Terminal Block (IP67 Models)

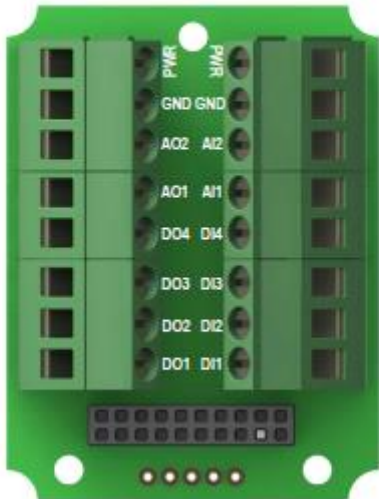

The Power can be connected to either of the PWR and GND terminals.

10-30VDC

The Digital Output for Relay 4 (Hi or Lo level) is connected to DO1

The Digital Output for Relays 5 & 6 (Wiper Fail and LOE) is connected to DO2

The Analogue Output for Channel 1 is connected to AO1

The Analogue Output for Channel 2 is connected to AO2

The systems supplied by Pulsar are 'paired' and care should be taken to ensure the right Receiver is installed with the appropriate Transmitter if more than one system is in operation on the same site.

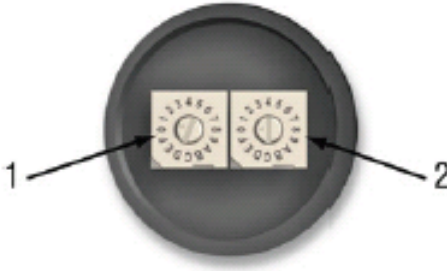

The left dial represents the units of the device.  
The right dial represents the tens of the device.

The receiver unit should be pre-set to 11 or greater, the transmitters are set to 1 or greater, so for a transmitter address of, for example, 4 the receiver will be 14 and so on. These are pre-set as the transmitter rotary dial are difficult to access.

### *Receiver Specifications*

Max distance between Transmitter & Receiver with a clear line of sight is 3km.

Frequency. 2.4 GHz







Enclosure. Polycarbonate IP67, NEMA 6.

Power. 10-30vdc consumption less than 1.4W at 24VDC

Temp. (electronics) -20 to +80 C

### Verifying Communications.

After powering up, verify the device is communicating properly.

LED 1	LED 2	Gateway Status	Node Status
 (green on)		Power ON	
 (green flashing)			RF Link OK
 (red flashing)	 (red flashing)	Device Error	Device Error
	 (yellow flashing)	Modbus Communication Active	
	 (red flashing)	Modbus Communication Error	No radio link (when flashing once every three seconds)

When testing the Gateway and Node, ensure all radios and antenna are at least two metres apart or communications may fail.

*Enclosure Dimensions*

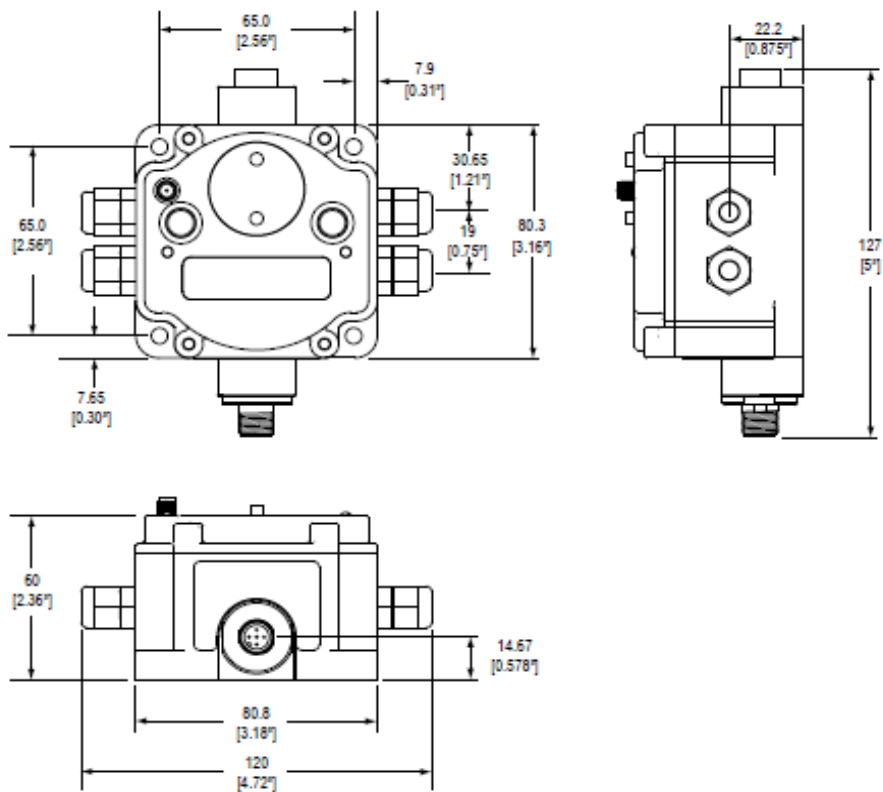

***Radio Telemetry Features.***

- Up to 48 repeaters can be used by upgrading to a 'MULTIHOP' receiver vastly increasing the distance between transmitter and receiver.
- Transmissions are always secure due to 'Frequency Hopping' technology.
- Unlimited pairs can be used in the same location.
- Light, strong, compact, and easily fitted enclosure.
- Other options are available on request such as RS485 comms and Solar Powered capability.
- 3km distance between Transmitter and Receiver, with clear line of sight.

***Pulsar Non-Integrated Point – Point Radio Telemetry.***

Pulsar also offer a non-integrated Radio Telemetry System that is available to be retro fitted.

The unit offers 2 x 4-20 Analogue Output and 4 x Digital Output re-transmission over 3km line of sight.

*Receiver*



*and*

*Transmitter Dimensional Details.*



PULSAR MEASUREMENT

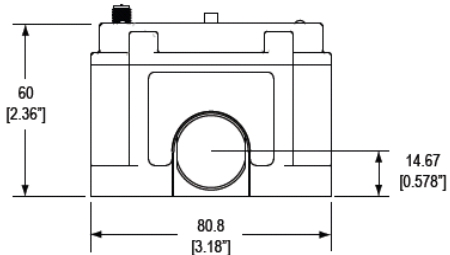
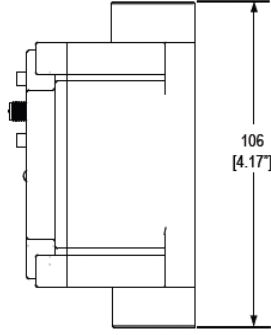
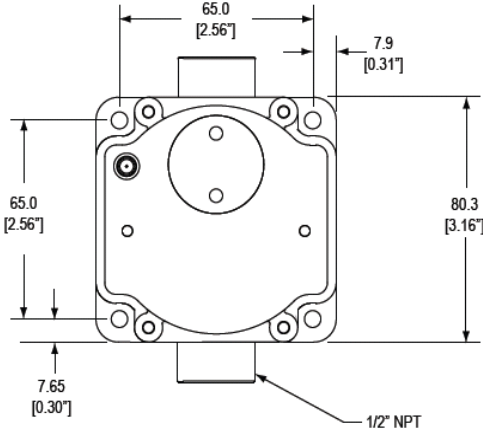

### **Gateway and Node wiring details**

*Applying power to the DX70 Radio Devices.*

Connect power to the Gateway and Node by connecting 10-30VDC directly to the terminal block as shown below.

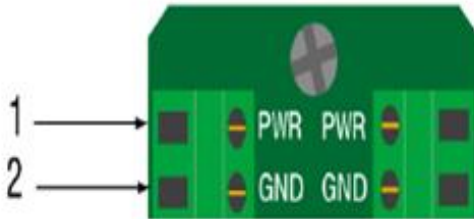

1 = 10-30VDC

2 = Ground

## Analogue and Digital I/O

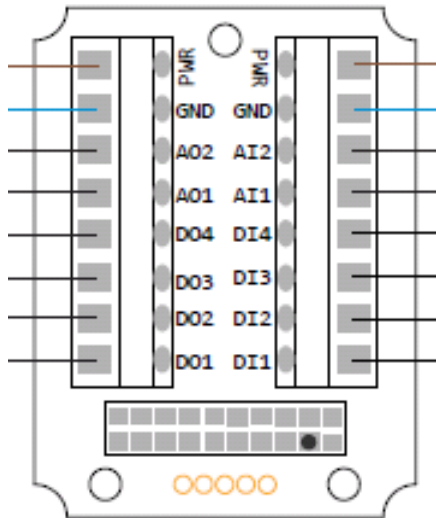

TERMINATION	NODE	GATEWAY	TERMINATION
A11	Analogue Input 1	Analogue Output 1	AO1
A12	Analogue Input 2	Analogue Output 2	AO2
D11	Digital Input 1	Digital Output 1	DO1
D12	Digital Input 2	Digital Output 2	DO2
D13	Digital Input 3	Digital Output 3	DO3
D14	Digital Input 4	Digital Output 4	DO4
A11	Analogue Input 1	Analogue Output 1	AO1
A12	Analogue Input 2	Analogue Output 2	AO2

The Pulsar units will be supplied already 'bound' and correctly addressed this means they will only talk to each other and cannot be externally interrogated.

When power is applied the units will show a solid green led and a flashing yellow led that will indicate they are communicating and all is normal, as shown below the speed of the flashing yellow led indicates the strength of the signal between the devices.

### Installation Tips

It is important to create a clear communication path.

Wireless comms can be hindered by radio interference and obstructions in the path between the radio and receiver. To achieve the best performance carefully consider the installation locations for the Gateways and Nodes, select locations without obstructions in the pathway between them.

Increase the height of the Antenna.

Position the antenna vertically for optimal RF communication, if necessary, change the height of the radio or antenna to improve reception. For outdoor applications mounting the antenna on top of a pole or building may help to achieve line of sight radio link.

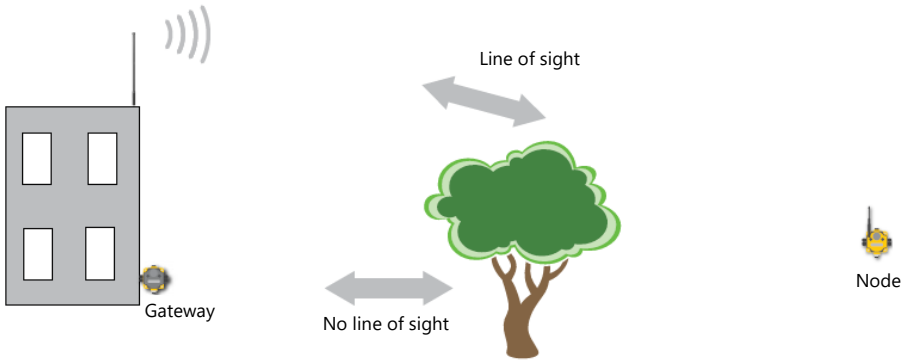

*Be Aware of Seasonal Changes.*

Seasonal changes may affect signal strength, leaves on trees that were absent during a site survey can become a problem later in the year.



A good signal strength in winter does not always mean you will get the same signal strength the rest of the year.



During spring and summer, leaves may block more of the radio signal.

*Further Antenna Installation Information.*

It is very important that the Radio Antenna is installed correctly for the Radio Communication to be reliable under all conditions.

Pulsar only supply External Antenna; these Antenna are weatherproof if installed correctly.

Pulsar also supply 4m extensions for both the receiver and transmitter end to ensure there is sufficient flexibility for Antenna positioning.

The Antenna always need a **CLEAR LINE OF SIGHT** to each other to maintain reliable communication, care should be taken if either the transmitter or receiver end is installed on moving machinery. Or, the installation takes place in winter and foliage growth during the summer months could block signal.

Radio signal does not penetrate metalwork or water so special care should be taken avoiding these objects within line of sight.

The 4m length of cable at each end should not be tightly coiled, care should be taken during the installation to ensure, if possible, the extension cable is run in such a way as to make extensive or tight coiling of the remainder unnecessary.

### *Bridge Integrator-Radio Schematic*

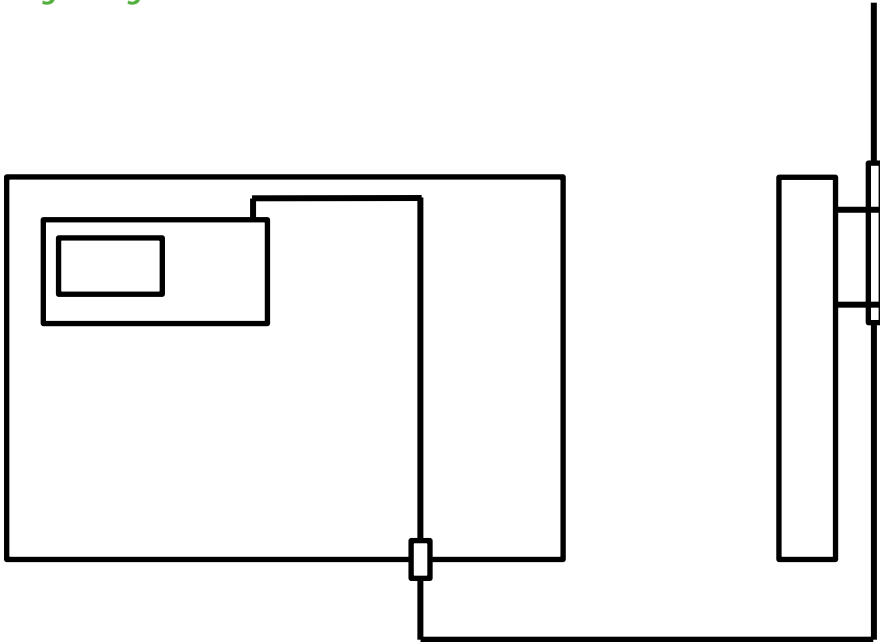

The Integrator on the Bridge should be protected from the elements inside an enclosure, the Antenna extension cable should be installed through a cable gland in the base of the enclosure and out to a suitable position so that the Antenna is above the enclosure.

If the installation position at either end is thought to be susceptible to a lightning strike then a surge suppressor can be installed in place of the cable gland, this installation would require an additional small extension cable from the integrator to the surge suppressor which is a bulkhead fitting. Please contact Pulsar for details.

## Specifications

<b>Radio Range</b>	2.4 GHz up to 3km.
<b>Radio Transmit Power</b>	18dn conducted, less than or equal to 20dbm EIRP.
<b>Radio Compliance</b>	FCC ID UE300DX80-2400 This device complies with FCC Part 15 Subpart C 15.247 ETSI/EN In accordance with EN 300 328: V1.7.1 (2006-05). IC 7044A-DX8024
<b>dB series (Air) Maximum Separation</b>	3,280 ft (1,000m)
<b>Spread Spectrum Technology</b>	FSSS (Frequency Hopping Spread Spectrum)
<b>Link Time Out</b>	Adjustable
<b>Power</b>	+10 to 30VDC Consumption less than 1.4W (60ma) at 24vdc
<b>Housing</b>	Polycarbonate housing, nitrile rubber button covers. Mounting M5, Weight 0.26kg
<b>Antenna Connection</b>	External reverse polarity SMA 50 Ohms, max tightening torque 0.45Nm
<b>Interface</b>	Red/Green Power LED, Red/Yellow Signal LED
<b>Wiring Access</b>	½" NPT
<b>Inputs</b>	Discrete I/P OFF condition, PNP Less than 5V, NPN Greater than 2V or Open. Analogue I/P Rating 24ma, Impedance 100 ohms, Sample Rate 1 second or 1%, Resolution 12bit
<b>Outputs</b>	OFF State Leakage Less than 10 micro amps, Max End to End Latency 300 milliseconds. Analogue Outputs. Update Rate 125ms Accuracy 0.1%, Resolution 12bit
<b>Environmental</b>	Rating IEC IP67, NEMA 6. Operating temp -40 to 85°C. Operating Humidity 95%. Radiated Immunity 10v/m, 80-2700MHz (EN61000-6-2)
<b>Shock and Vibration</b>	IEC 68-2-6 and IEC68-2-7, Shock 30g 11ms half sine wave, 18 shocks, Vibration 0.5mm p-p 10 to 60 Hz.



## HOW TO USE YOUR SLUDGEFINDER 2

### *Operating the Controls*

#### *Display*

The graphical display provides four levels of runtime information and a sophisticated, progressive menu system in program mode.

While in **Run Mode**, the '**Main**' screen displays the current level reading and its units of measure, with a graphical representation of level for point 1 and/or point 2 along with status information with regards to the Transducer, Echo reception, Wiper status and Fail Safe Mode via the hotkeys. To scroll between run mode screens, use the left and right arrow keys (see diagrams below). To switch between points, use the up and down arrow keys.

The '**Echo**' screen shows the live echo trace of point 1, point 2 or both on the same screen, with various viewing options described later in this chapter.

The '**Range**' screen gives details of the empty level, span and blanking for point 1 or point 2.

The '**Relays**' screen gives live information on relay type and current state, a graphical representation of on and off setpoints and the current level for point 1 or point 2.

When in **Program mode**, the display is used to read information on the menu system, parameter details and the values that can be entered.

During **Test Mode** the display is used to monitor the simulated level with a screen like the '**Main**' screen in Run Mode. The current test mode (auto/manual hard/soft) will also be shown at the bottom of the screen.

There are two main operating modes for your Sludge Finder 2, **Run Mode** and **Program Mode**. There is also a **Test Mode**, used for checking the set-up. All modes are now described.

### Run Mode

This mode is used once the Sludge Finder 2 has been set up in program mode. It is also the default mode that the unit reverts to when it resumes operation after a power failure.

When Sludge Finder 2 is switched on for the first time, it will display, in metres, a level measurement relating to the default tank dimensions. All relays by default are switched off.

After programming is complete, any relays that are set will operate when the level reaches the relevant setpoint, and the LED's will change colour (unless specifically switched off).

### Main

This group of screens provides information on Point 1, Point 2 or an overview of both Points. Use the up and down arrows to scroll between points 1, 2 or both. Below is an example of point 1, this is the screen that will be displayed when the Sludge Finder 2 is switched on for the first time.

Tank overview showing a graphical representation of the sludge level in percentage of span.

Sludge level in percentage of

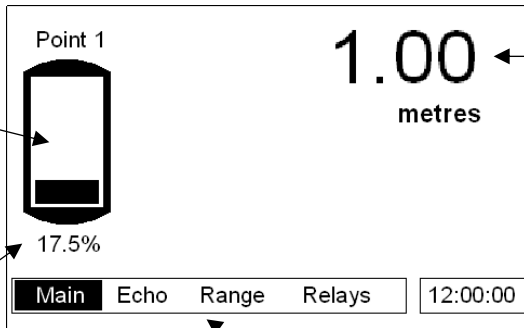

Current sludge interface level in measurement units

Clock

Display modes - current mode is highlighted.

Error messages, such as "Wiper Fault", "Status = LOE" or "Status = Failed" will be displayed on this screen, relating to the point of measure currently being viewed, when a fault condition occurs.

### Echo

The echo screen displays the echo data. Below is an annotated example of a typical secondary settlement tank sludge interface.

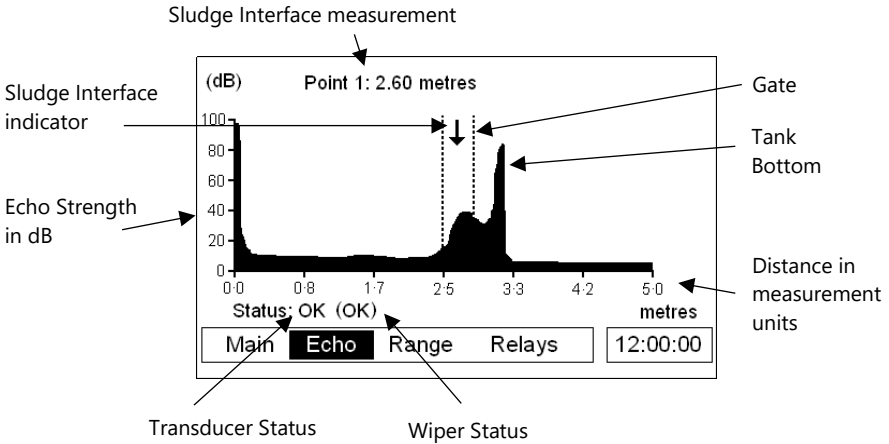

### Range

This screen gives details of the current interface level and the range settings held in the Sludge Finder 2.

- P107 = Near Blanking Distance
- P106 = Span
- P105 = Empty Distance

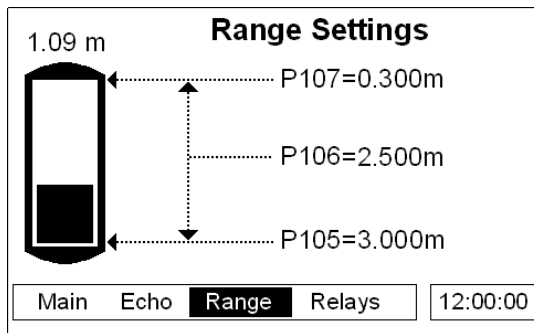

**Relays**

The relays screen indicates the current state of all relay outputs and gives a visual representation of the current interface level and the on and off setpoints of the individual relays. The level icons, e.g., "➔" (point 1), represent the level reading of the transducer that the corresponding relay is assigned to (see table below). Relays that do not relate to level will be displayed without the graphical representation of level setpoints but will still show the relay number and status.

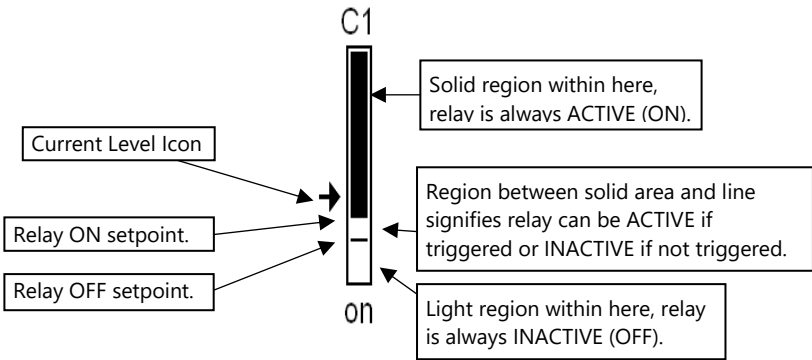
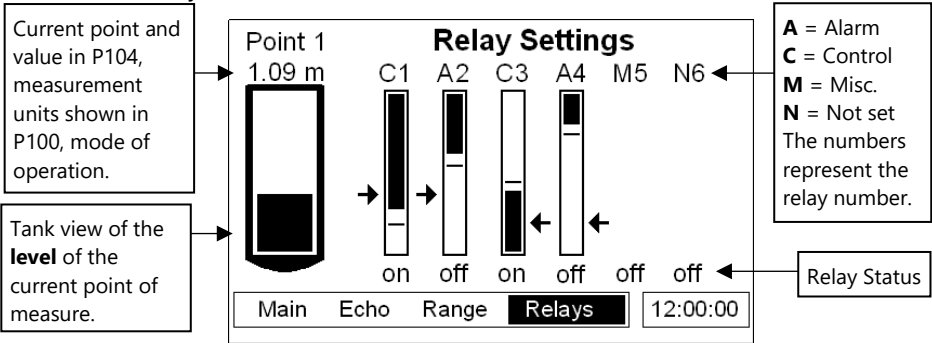

LEVEL ICON	DESCRIPTION
➔	Point 1 Level, shown on left hand side of relay diagram.
➜	Point 2 Level, shown on right hand side of relay diagram.
◆	Average level, shown on left hand side of relay diagram.
+	Sum of levels, shown on left hand side of relay diagram.
—	Differential level, shown on left hand side of diagram.

All icons show the measurement from the vertical centre of the icon.

## Program Mode

This mode is used to set up the Sludge Finder 2 or change information already set. You must use the built-in keypad to access program mode. Alternatively, the unit can be set up with a PC via the RS 232 Serial Interface. Entering a value for each of the parameters that are relevant to your application provides all of the programming information.

### How to Access Program Mode

With Sludge Finder 2, to enter **program mode**, you simply enter the passcode, via the keypad, followed by the ENTER key. The **default passcode** is **1997**, so you would press the following:



### Important Information

There is a time-out period of 15 minutes when in program mode. After which time the run mode will resumed if you do not press any key.

### Screenshots of program mode

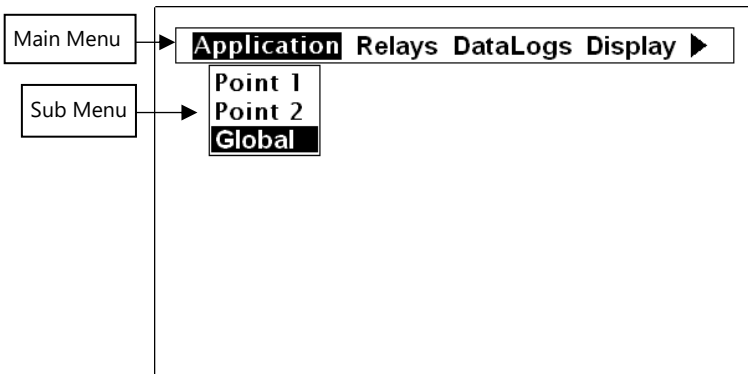

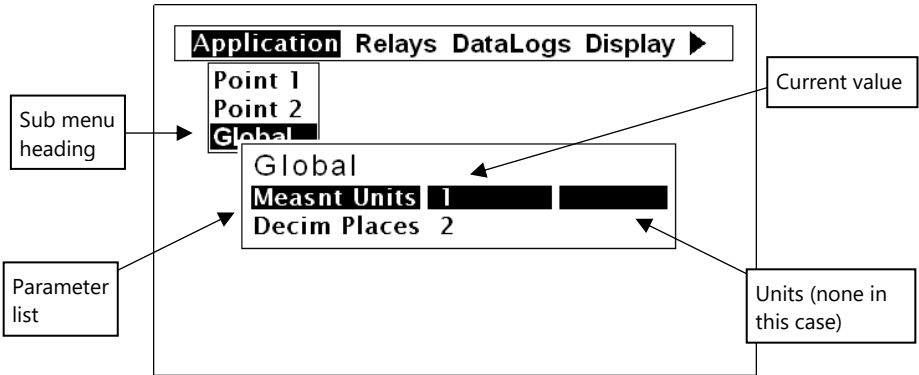

*Information screen*



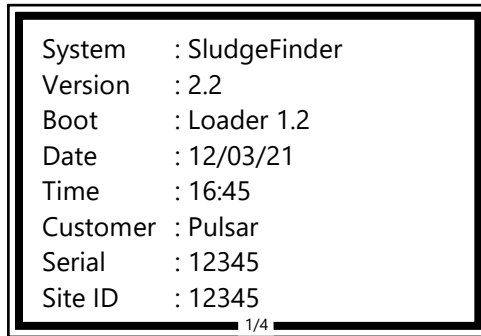



The information screen can be used to view system details such as Software revision, serial number etc. but can also be used to view a summary of the application settings. To access the information screen, press the  button when the Sludge Finder 2 is in *run mode*. There are 4 pages within the information screen, preceded by the pulsar logo, showing the current page number at the bottom centre of the information screen. The screens will automatically scroll but can also use the left and right arrow keys to toggle between pages an example of page 1 is shown below:



PAGE	DESCRIPTION
1	General information on the system. See example above
2	Information on communications set up: RS232 and RS485 (if available)
3	Information on application set up, such as; transducer type, mode, empty level etc.
4	Information on mA output setup such as; allocation etc.







### Hot Keys

There are five hot keys on the keypad that can be used to quickly access common parameters for viewing only, while in Run Mode. Pressing the hot key once will initiate or toggle the function assigned to that key, then the Sludge Finder 2 reverts to the Run Mode display, if applicable. In program mode, they have different functions. Information displayed by the function keys in the "Main" screen will timeout and disappear after 20secs. The functions are shown below:

HOT KEY	RUN MODE	PROGRAM MODE
	Toggle status, echo strength, wiper status and temperature display in the "Main" screen. Toggle the Gate display in the "Echo" screen.	Clear the current value
	Toggle distance, level, and space display in "Main" screen. Toggle the DATEM trace in "Echo" screen.	Not used with Sludge Finder 2
	Toggle mA output display in the 'Main' screen Toggle the the Raw echo in the "Echo" screen	Reset parameter to default setting
	Not used with Sludge Finder 2	Not used with Sludge Finder 2
	Initiates a wiper sweep on the sludge transducer face (VT transducers on single point main display only).	Not used with SludgeFinder 2
	Not used with SludgeFinder 2	Toggle negative values
	Displays the information screen, timeout 20 seconds.	Enter decimal point.

**Menu Keys**

The menu keys have the following functions:

HOT KEY	FUNCTION
 	<ol style="list-style-type: none"> <li>1) Arrow keys for moving left and right around the menu system and used as a backspace when editing the value of a parameter.</li> <li>2) Used for changing display modes in Run Mode.</li> <li>3) Used in test mode to simulate the level moving up and down (Right = up, Left = down)</li> </ol>
 	<ol style="list-style-type: none"> <li>1) Used to for moving up and down through the menu system)</li> <li>2) Used for changing displayed point of measurement in Run Mode.</li> </ol>
	<ol style="list-style-type: none"> <li>1) Used to confirm each action (for example, select a menu option or accept a parameter number or value).</li> <li>2) Used to confirm questions asked by your Sludge Finder 2 such as before restoring factory defaults.</li> </ol>
	<p>When in 'program mode' used to navigate back a level in the menu system or back to run mode. Cancel a value entered in error. When in 'run mode' used to re-initialise the SF2 echo trace if the unit is thought to be reading the incorrect value. This function should only be used by experienced users, see Service Manual for further details.</p>



***Numeric Keys***

These keys are used for entering numerical information during programming.

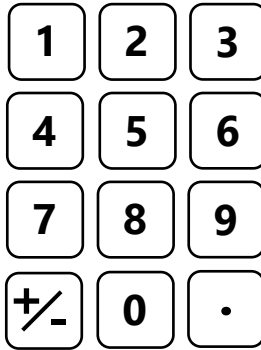

There are two means of editing parameters, directly or using the menu system. Each is now described.

**Using the Menu System**

The menu system has been designed to make the changing of parameters very simple. There are two levels of menu: **Main Menu** and **Sub Menu**.

At the top of the display there is a line of text that displays the main menu items. Pressing the left/right arrow keys scrolls the display between the top-level menu items, (as the example shown below, starting at Application).

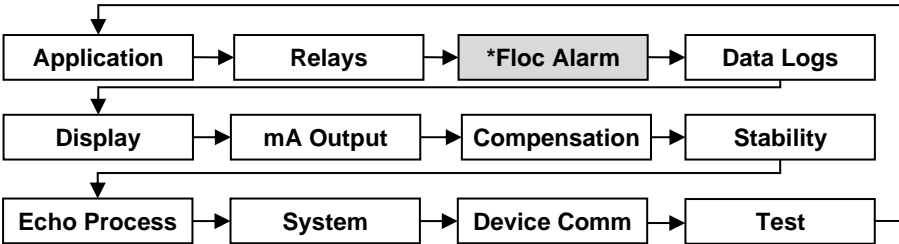

***\*This is only available in units with firmware version 1.1.0 or greater***

As you press the cursor keys to scroll left and right between these, you can press ENTER, or the down arrow, at any time, to expand the sub-menu.

Each menu options, along with their sub-menus, is described later in this manual. When you move down into the sub-menu, you can scroll up and down using the arrow keys and then press ENTER to go to the required parameter lists. If there are more menu options or parameters than can be viewed on the display in one go, then a scroll bar will appear on the right hand side of the menu/parameter box. The position of the solid bar within the scroll bar provides a visual aid as to your position in the current menu.

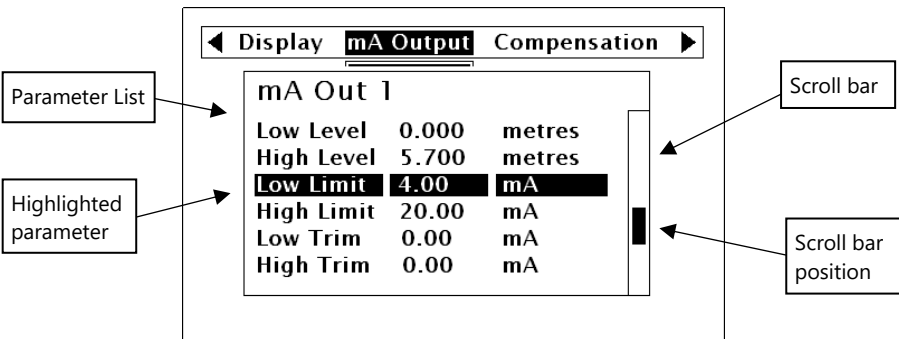

Once you have reached the relevant section, scroll down the parameter list to highlight the parameter you wish to edit, and press ENTER to access the parameter options. When you are at parameter level, the options for that parameter will be displayed on the screen. If the parameter has pre-set options then scroll up or down, with the up/down arrow keys, or press the designated number key (displayed on the left hand side) to highlight the option, then press ENTER to save. If the parameter requires you to enter a value within a particular range, the range options will be displayed with a box to enter the value. Use the numeric keypad to enter the required value following the onscreen prompts and press ENTER to save.

When you have finished, press CANCEL to go back to the previous menu level. When you have reached the top level, press the CANCEL button again, the Sludge Finder 2 will ask for confirmation before allowing you return to run mode. This is done by pressing ENTER at the display prompt.

### ***Directly Editing Parameters***

If you already know the number of the parameter, that you wish to look at or edit, simply type the number in at any time while you are in the menu system. Thus, if you are in either the menu or sub-menu level by pressing a numeric key, you can enter the parameter number directly and jump straight there. You cannot type a parameter number whilst at parameter level, only at one of the two menu levels.

When you are at a parameter, the text line rotates automatically displaying the parameter name, number, the applicable units, and the maximum and minimum figure you can enter. The top line shows the value you are setting.

Once you have accessed a parameter, you can either just look at it, or change it.

Once a parameter has been changed, press ENTER and you will see the parameter value changed in the parameter list. If you press CANCEL then you will be returned to the parameter list with no change to the values.

### Test Mode

Test mode is used to simulate the application and confirm that all parameters and relay setpoints have been entered as expected. During simulation, there is a choice of whether the relays will change state (hard simulation) or not (soft simulation), but the LED's will always change colour as programmed, and the mA outputs will change in accordance with the chosen mode of operation. If you wish to test the logic of the system that the **relays are connected** to then select **hard simulation**, but if you **don't wish to change the relay state**, then select a **soft simulation**.

There are two modes of simulation for each point of measurement, automatic and manual. Automatic simulation will move the level up and down between empty level or the pre-determined **Start Level (P983)** and the span, if you wish to change the direction of the level movement, this can be done by using the left/right arrow keys. In manual simulation, using the up/down arrow keys will allow you to move the level up and down as required.

To enter simulation, first go to **program mode**. Using the menu system, select menu item '**Test**', then sub-menu item '**Simulation**'. Select the point of measure you wish to simulate and press enter to access the simulation options. You can change the value of the parameter to one of the following:

- 1= Manual soft simulation
- 2= Automatic soft simulation
- 3= Manual hard simulation
- 4= Automatic hard simulation

When in test mode, the display will show the graphical **level** indicator with the current mode of operation value in measurement units. Also shown will be the relay setpoint indicators, for each relay, with an arrow showing the current level relevant to that relay allocation e.g. if you are simulating point 1 then the level indicator will move up and down along with the arrows next to any relay allocated to point 1. If a relay is allocated to sum, average or differential, then the Sludge Finder 2 will span the relay diagram to the sum, average or differential of point 1 and 2. The level of point 2 (or point 1 if simulating point 2) will always remain at 0.

To return to program mode, press CANCEL and test mode will end.

When in **manual** simulation, by default test mode will move the level by 0.1m steps. Altering the **increment (P981)** will change this value.

In **automatic** mode, the rate at which the level moves up and down is set by the **increment (P981)** in metres, the **rate (P982)** in minutes, which can be changed to make the level move up and down faster. E.g., if **increment (P981)** is set for 0.1m and **rate (P982)** is set to 1 min then the level will increase or decrease at a rate of 0.1m/min. To make the simulated level move slower, decrease the value in **increment (P981)** or increase the value in **rate (P982)**. To make the simulated level move faster, increase the value in **increment (P981)** or decrease the value in **rate (P982)**.

### *Using the Serial Interface*

The RS232 serial interface is used to communicate between the Sludge Finder 2 and a PC using the optional Sludge Finder PC software and other associated Pulsar software packages. To obtain information such as data logging and view echo traces, upload, download and save parameter files. In addition it can also be used to control or obtain information using a standard PC or other computer base equipment. To do so, the default settings for communications port are as follows: **baud rate 19,200, 8 data bits, no parity, 1 stop bit**.

The device should be connected as shown in [Chapter 2 Installation](#).

To use the device remotely, you need to **log on** to start, and **log off** when finished. When **logged on**, Sludge Finder 2 will show "**Remote**" on the display in place of the clock. When logged off, the display will return to normal (clock will be displayed).

*All commands should be followed by a carriage return.*

The unit will respond either OK or a value if the command is accepted, or NO if the command is not recognised or is not available.

**To log on**, send the command

/ACCESS:pppp where pppp is the passcode (P922).

**To log off**, send the command

/ACCESS:OFF

To set a parameter, send the command

/Pxxx:yy where xxx is the parameter number, and yy is the value you wish to set it to.

Other commands you can use are:

/DISTANCE 1 (shows current distance of point 1)

/DISTANCE 2 (shows current distance of point 2)

/LEVEL 1 (shows current level of point 1)

/LEVEL (shows current level of point 2)

/TEMP1 (shows current temperature of point 1)

/TEMP2 (shows current temperature of point 2)

/CURRENTOUT1 (shows the mA output value for mA output 1)

/CURRENTOUT2 (shows the mA output value for mA output 2)

Please consult Pulsar Measurement or contact your local Pulsar representative for further details and a full list of available commands.

## Parameter Defaults

### Factory Defaults

When first installing the Sludge Finder 2, or subsequently moving or using the unit on a new application, before proceeding to program the unit for its intended application it is recommended that you ensure that all parameters are at their default values by completing a **Factory Defaults P930**, as described in the **parameter guide**.

When you first switch Sludge Finder 2 on, it will be reading the **distance** from the face of the transducer to the interface. It will be indicating in **metres**, as shown on the display and all relays are set OFF.

The **date** (P931) and **time** (P932) in Sludge Finder 2 were set at the factory, but may need checking, and amending if, for example the application is in a time zone other than GMT, see relevant unit **Parameter listing** for full details.

Once you are satisfied with the installation, and Sludge Finder 2 is reading what you would expect in terms of distance from the face of the transducer to the material level, then you can proceed with programming for the intended application. It is sensible to program all of the required parameters at the same time. The system will then be fully set-up.

Once you are satisfied with the installation, and the SludgeFinder 2 is reading what you would expect in terms of distance from the face of the transducer to the material level, then you can proceed with programming, for the intended application. It is sensible to program all of the required parameters at the same time. The system will be then set-up.

**Note:** *The span is automatically calculated from the empty level, so the empty level should be entered first.*

## CHAPTER 4 PROGRAMMING GUIDE

### *Measurements needed for Interface monitoring*

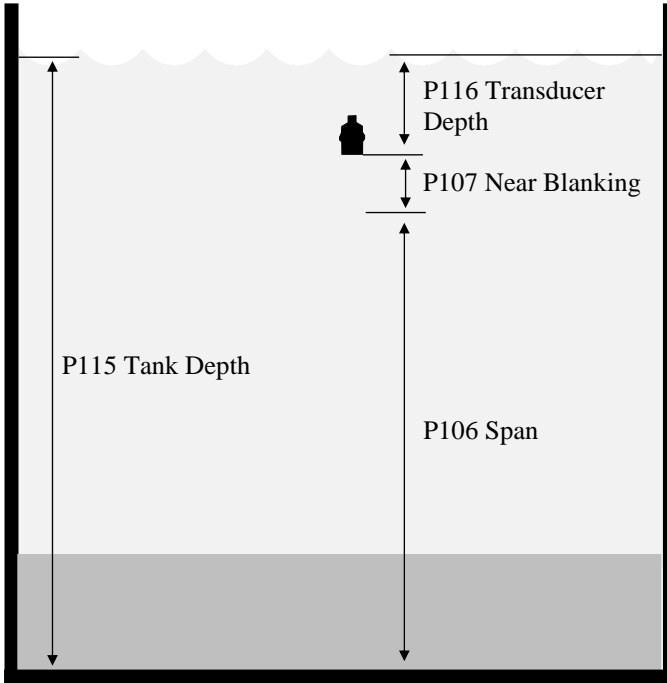

**Measured tank depth and Transducer depth are referenced from the same point – Top water level.**



### Example 1: Primary Settlement Sludge Interface monitoring

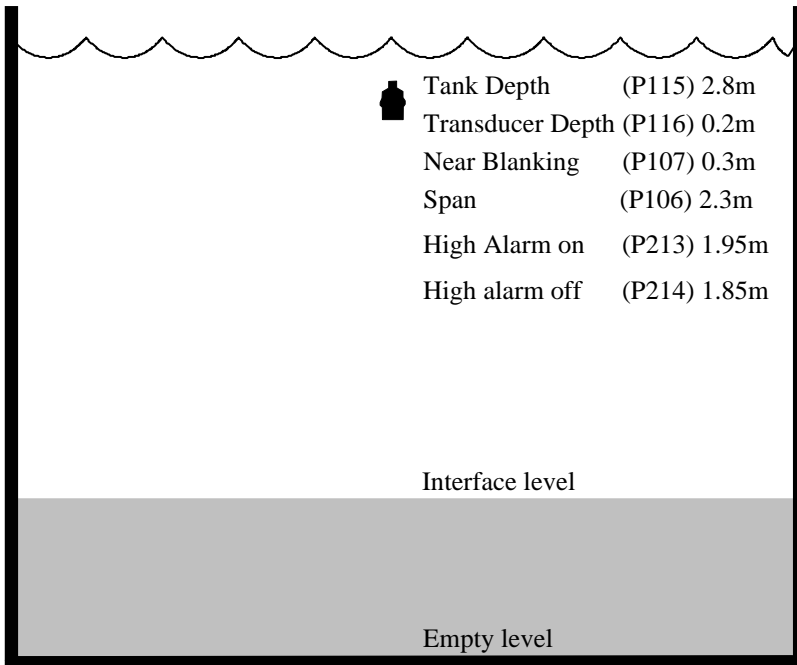

In this example, when the sludge interface level rises to 1.95 m, relay 1 will come on until the level drops to 1.85 m when it will turn off.

The display for point 1 will show the sludge interface level in the tank.

The mA output will be representative of sludge interface level where 4mA = empty level (0%) and 20mA = 2.3m (100%).

To program the unit for **Example 1 Primary Settlement Sludge Interface Monitoring**, proceed as follows.

If required access the **Program Mode**.

Key in the **passcode** 1997 and press **ENTER**.

Use the arrow keys to scroll to the following menus and parameters and press **ENTER** to access them. Select the relevant option using the up and down arrows or type in the required value using the keypad and press **ENTER** to accept.

MENU	SUB MENU	PARAMETER	VALUE/OPTION
Application	Point 1	Mode P100	2 = Level
		Xducer P101	7 = VT10
		Material P102	2 = Primary
		Tank Depth P115	2.8 (metres)
		Xducer Depth P116	0.2 (metres)
		Span P106	2.3 (metres)
	Global	Meast Units P104	1 = metres
Application	Relay 1	Type P210	1 = Alarm
		Function P211	1 = Level
		Ident P212	2 = High
		Setpoint 1 P213	1.95 (metres)
		Setpoint 2 P214	1.85 (metres)
		Allocation P216	1 = Xducer 1

All other parameters should remain at default values.

If combining the sludge interface monitoring with a tank liquid level monitor then proceed to **Example 1b Level Monitoring with Alarms on Point 2** otherwise, programming is now complete and the unit can be returned to the run mode, press **CANCEL** until **Run Mode?** Is displayed on the LCD press **ENTER**, and the Sludge Finder 2 will return to the **Run Mode**.

### Setting Up Point 2 with as an Ultrasonic Point of Measurement

If it is required that point two is to be set up as an ultrasonic transducer to measure level in air, follow the procedure as per the example below.

#### Example 2: Level Monitoring with High and Low Alarms on Point 2

A vessel, containing a liquid that has a variation in level that is to be monitored, with a high level alarm set on Relay 1, and low level alarm set on Relay 2. The following method uses an air transducer from the dB range, example shown is a dB6 on channel 2.

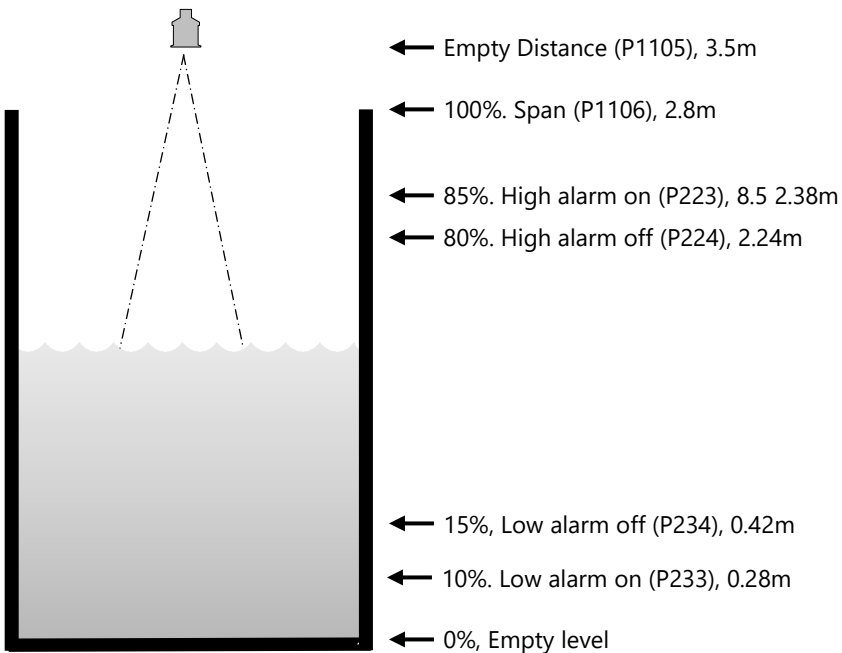

In this example, when the level rises to 2.38 m, relay 2 will come on until the level drops to 2.24 m when it will turn off. If the level drops to 0.28 m, then relay 3 will come on until it rises 0.42 m when it will turn off.

The display for point 2 will show the level in the tank.

The mA output will be representative of level where 4mA = empty level (0%) and 20mA = 2.8m (100%).

To program the unit for **Example 2 Level Monitoring with alarms**, proceed as follows.

If required access the **Program Mode**

Key in the **passcode** 1997 and press **ENTER**

Use the arrow keys to scroll to the following menus and parameters and press **ENTER** to access them. Select the relevant option using the up and down arrows or type in the required value using the keypad and press **ENTER** to accept.

MENU	SUB MENU	PARAMETER	VALUE/OPTION
Application	Point 2	Mode P1100	2 = Level
		Xducer P1101	2 = dB6
		Material P1102	1 = Liquid
		Empty Level P1105	3.5 (metres)
		Span P1106	2.8 (metres)
Relays	Relay 2	Type P220	1 = Alarm
		Function P221	1 = Level
		Ident P222	2 = High
		Setpoint 1 P223	2.38 (metres)
		Setpoint 2 P224	2.24 (metres)
		Allocation P226	2 = Xducer 2
	Relay 3	Type P230	1 = Alarm
		Function P231	1 = Level
		Ident P232	2 = High
		Setpoint 1 P233	2.38 (metres)
		Setpoint 2 P234	2.24 (metres)
mA Output	mA Out 2	Allocation P899	2 = Xducer 2

All other parameters should remain at default values.

Programming is now complete, and the unit can be returned to the run mode, press **CANCEL** until **Run Mode?** Is displayed on the LCD press **ENTER**, and the Sludge Finder 2 will return to the **Run Mode**.

*Example Echo Screen for Ultrasonic Transducer*

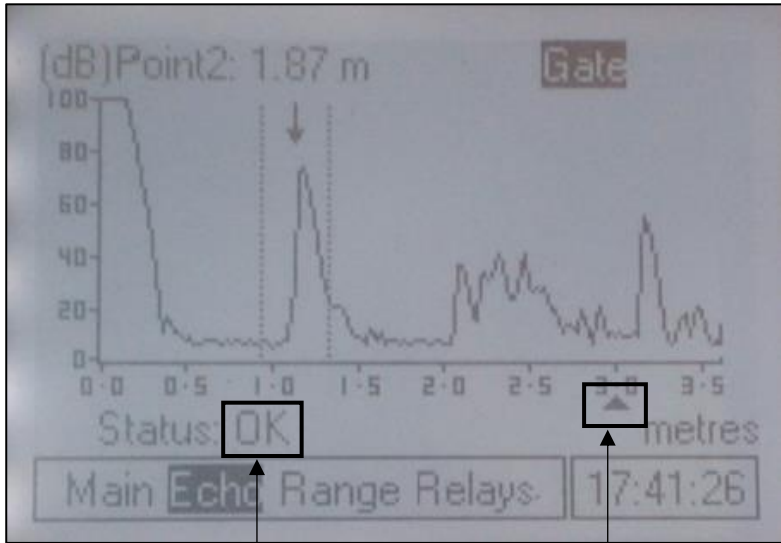

Status Indicator

Empty Distance Indicator

**Example 3: Using a Single Viper Transducer to Measure 2 Different Interface Levels.**

The Pulsar SF2 Integrator can be used to monitor both the Rag or FLOC levels and the Settled Sludge or RAS levels simultaneously using only one Viper Transducer.

This feature gives the user the ability to monitor and control the RAS level application by monitoring the settled sludge, but also prevent damaging FLOC spillage to the local water course by monitoring the less dense Rag levels.

To achieve this, we utilise Point number 2 in addition to Point number 1. Both points will display the same profile, but different service parameters can be applied thus setting Point 1 to monitor the RAS layer and Point 2 the FLOC layer.

It is required to set Point 2 Allocation in the Application menu (P1103) To 0 = Transducer 1.

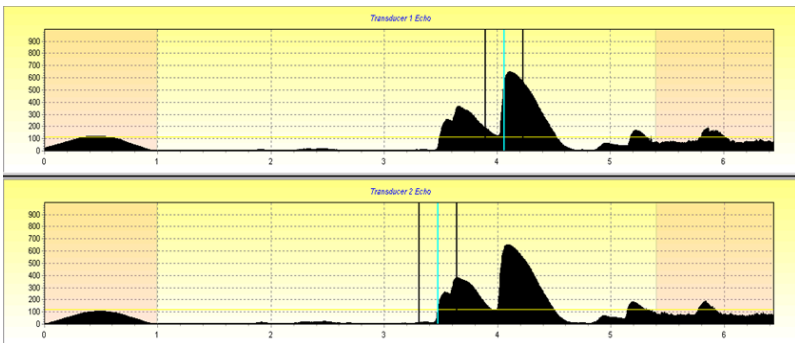

The above profiles show the unit differentiating between the two echoes. In this instance point one is set to pick the largest echo and point two is set to pick the first echo (see SF2 Service Manual for details).

Each 4-20ma can be independently set to track both interfaces.

All relays can be independently set to give control or alarms on both points.

**Example 4: Setting the Unit to Alarm on Hi-Floc Levels**

**High Floc Alarm**

The unit is now able to pick up on high level of floc readings, to do this it reacts to the raw echo trace rather than the processed echo. You are then able to set an alarm that is only reacting to the raw floc levels which will activate if the **% of intrusion (P163)** is reached between the distances set (in measurement units) in **P160 Start distance** and **P161 End Distance**. So if the reading is low and sat near the bottom of the tank the processed echo is low but the raw echo can be high.

The unit will pick up hi levels of floc near the surface which it can only do by looking at the raw trace. The alarm **On Delay P164** and **Off Delay P165** can be set to prevent passing 'clouds' of material in flight from nuisance alarming.

With the introduction of the High Floc Alarm feature, several different parameters and features now need to be included into the manual. Below are the illustrations, parameters and their descriptions which require adding to the new release of manuals due to be compiled indicating how to program a high floc alarm.

*Top Level Menu*

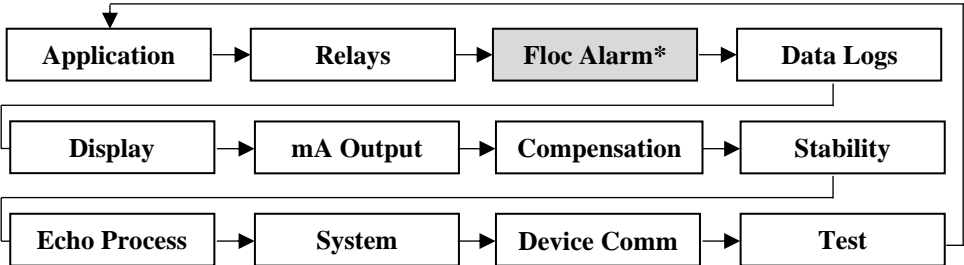

**\*This is only available in units with firmware version 1.1.0 or greater.**

*Setting up a High Floc alarm:*

**Note:** When setting a High Floc Alarm, it is necessary to access two menu systems the **RELAYS** menu to set up the relay and the **FLOC ALARM** menu to set the alarm parameters.

Enter program mode by keying in 1997 and pressing ENTER. Once in program mode you will need to program both a High Floc alarm relay and set up the parameters in the new Floc alarm menu option. Assigning an alarm relay to this new feature to alert you of a high floc presence, also allows you to view on the units trace screen the area box monitored by the Floc alarm parameters. How to set this alarm relay feature is explained in **Relay parameters**. The parameters required to setup a High Floc alarm are detailed in the [Chapter 6 Menu system and parameter guide](#) - Floc Alarm section.

The '**Intrusion Window**' appears in the top left hand side of the echo profile display when the 'Gate' hot key is pressed.

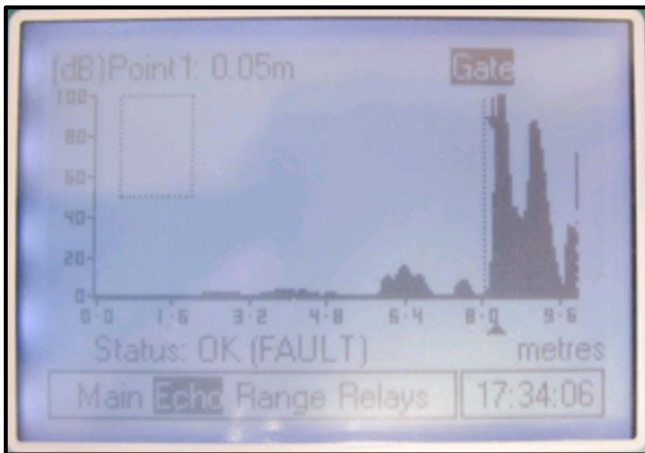

The '**Raw Echo**' (F3) should also be pressed to see if the Raw Echo profile is in the display is intruding into the window.



## CHAPTER 6 MENU SYSTEM AND PARAMETER GUIDE

This section outlines all parameters available in the Sludge Finder 2, as they appear in the menu system.

Shown below is a set of charts to show you how all the various parts can be found using the menu system.

For further details and a full description of all parameters refer to [Chapter 7 Parameter Listings and Descriptions](#).

### Top Level Menu

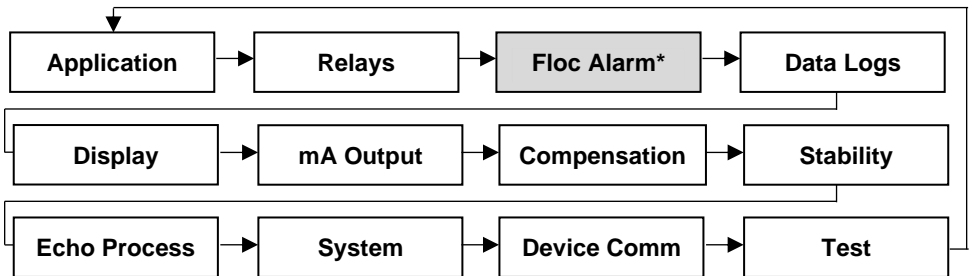

## Application Menu

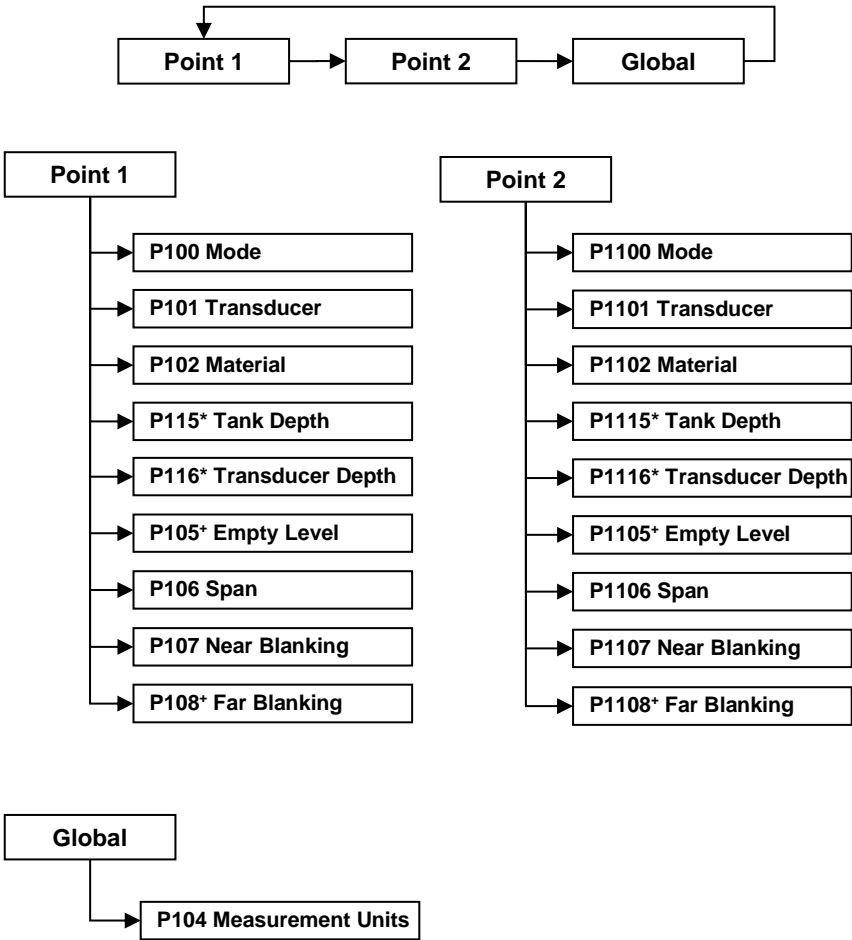

\* only available with VT transducers

\* only available with dB transducers

**Relays Menu**

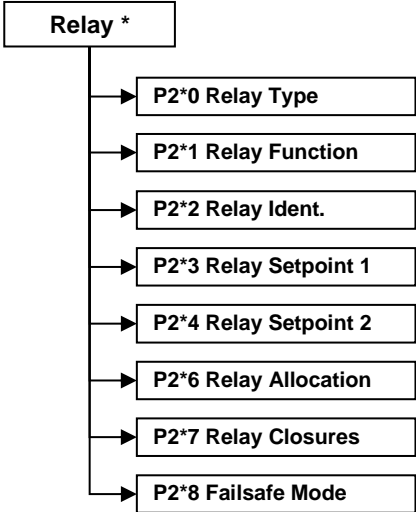
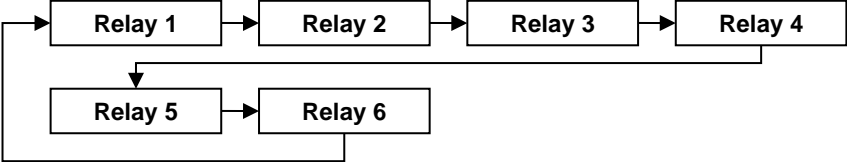

\* is the number of the relay from 1 to 6

**Floc Alarm Menu**

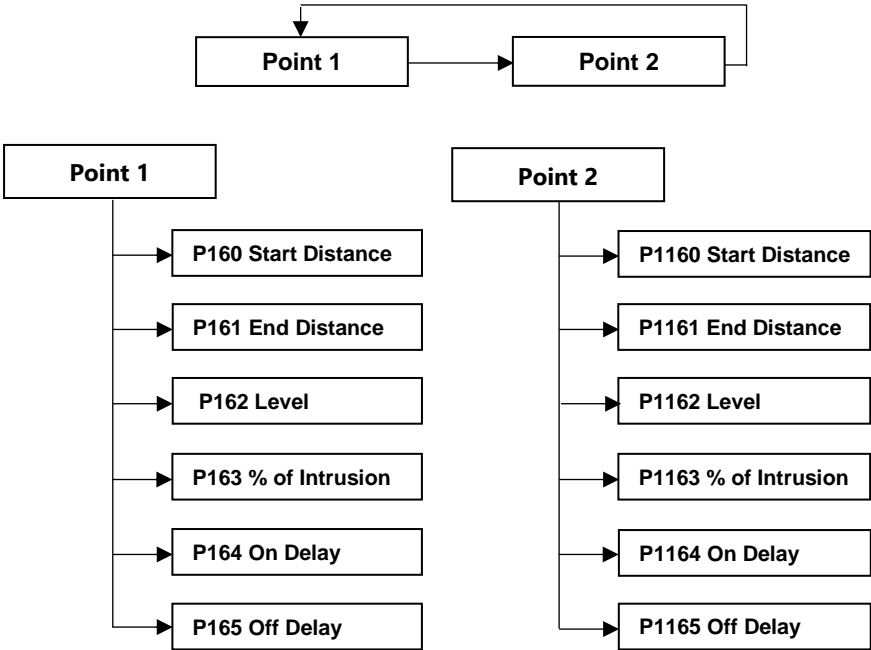

*Data Logs Menu*

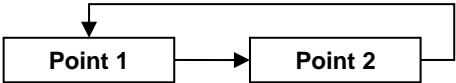

- P580 Min. Temperature
- P581 Min. Temp. Date
- P582 Min. Temp. Time
- P583 Max. Temperature
- P584 Max. Temp. Date
- P585 Max. Temp. Time
- P586 Current Temp.



- P1580 Min. Temperature
- P1581 Min. Temp. Date
- P1582 Min. Temp. Time
- P1583 Max. Temperature
- P1584 Max. Temp. Date
- P1585 Max. Temp. Time
- P1586 Current Temp.

*Display Menu*

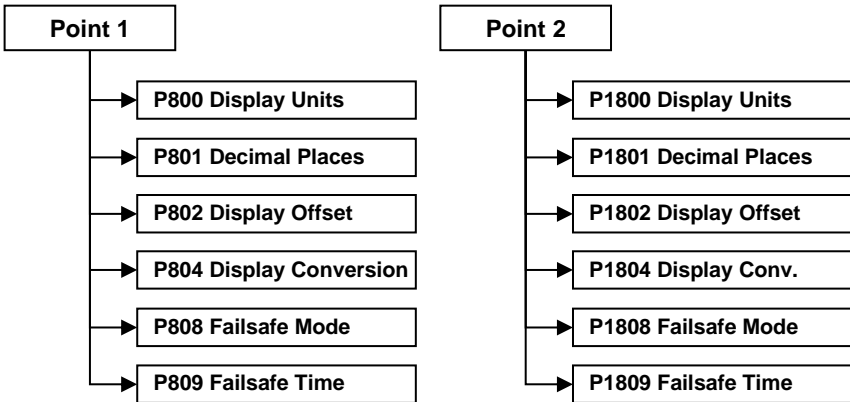
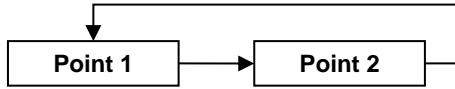

*mA Output Menu*

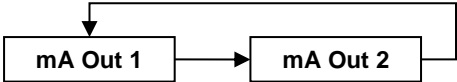

**mA Out 1**

- P830 mA Range
- P831 mA Mode
- P834 mA Low Level
- P835 mA High Level
- P836 mA Low Limit
- P837 mA High Limit
- P838 mA Low Trim
- P839 mA High Trim
- P840 mA Fail Mode
- P841 mA Allocation

**mA Out 2**

- P890 mA Range
- P891 mA Mode
- P892 mA Low Level
- P893 mA High Level
- P894 mA Low Limit
- P895 mA High Limit
- P896 mA Low Trim
- P897 mA High Trim
- P898 mA Fail Mode
- P899 mA Allocation

### Compensation Menu

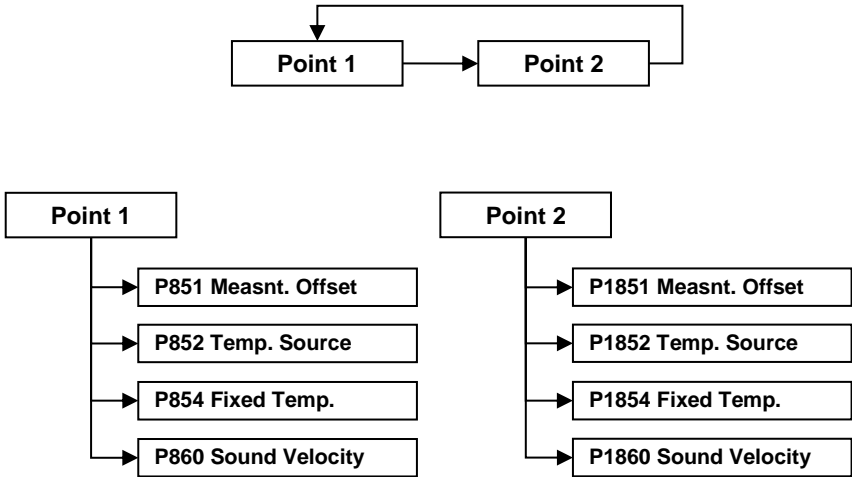

### Stability Menu

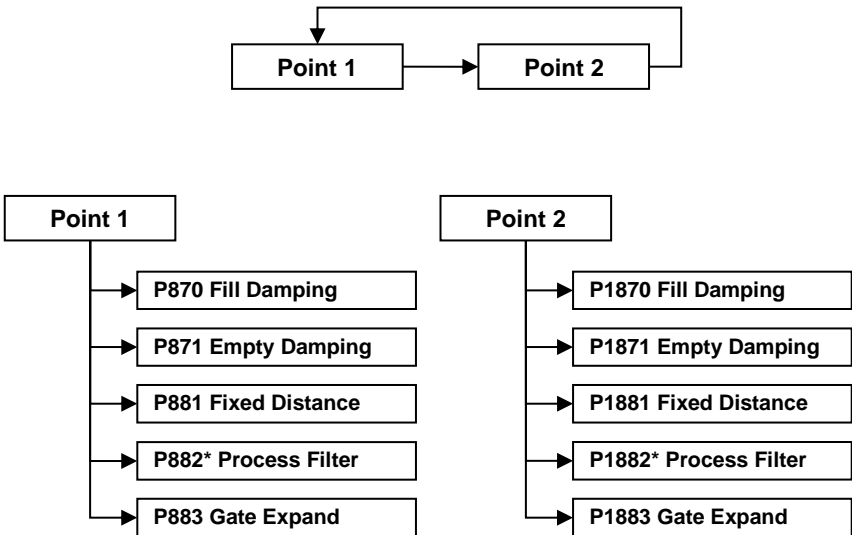

\* dB transducers only



*Echo Processing Menu*

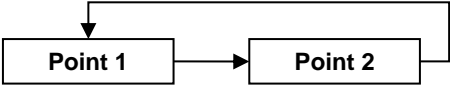

- P900 Transducer Status
- P901 Echo Confidence
- P902 Echo Strength
- P903 Average Noise
- P904 Peak Noise
- P905\* Sensitivity
- P906\* Side Clearance



- P910 Transducer Status
- P911 Echo Confidence
- P912 Echo Strength
- P913 Average Noise
- P914 Peak Noise
- P915\* Sensitivity
- P916\* Side Clearance

\* dB transducers only

**System Menu**

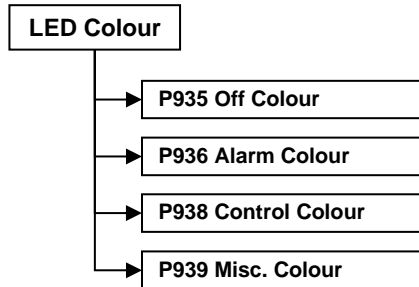
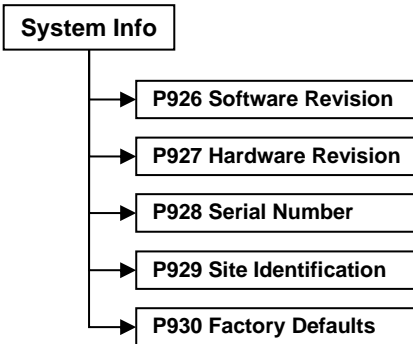
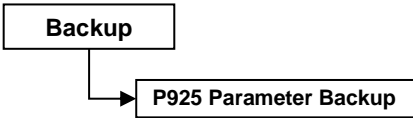
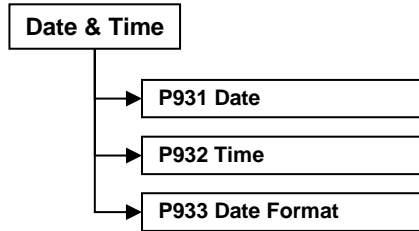
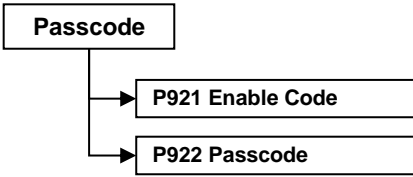
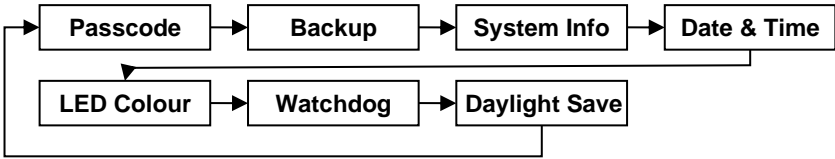

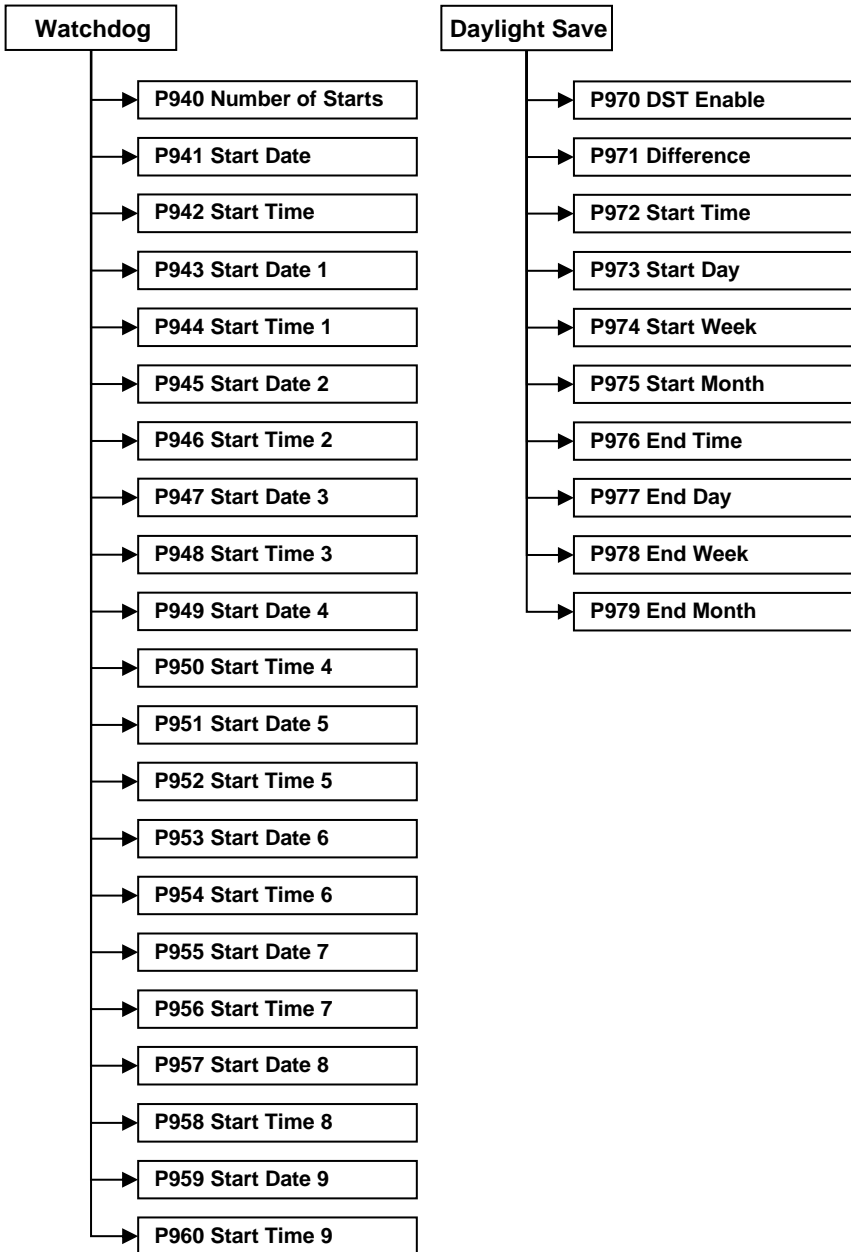

**Device Comm Menu**

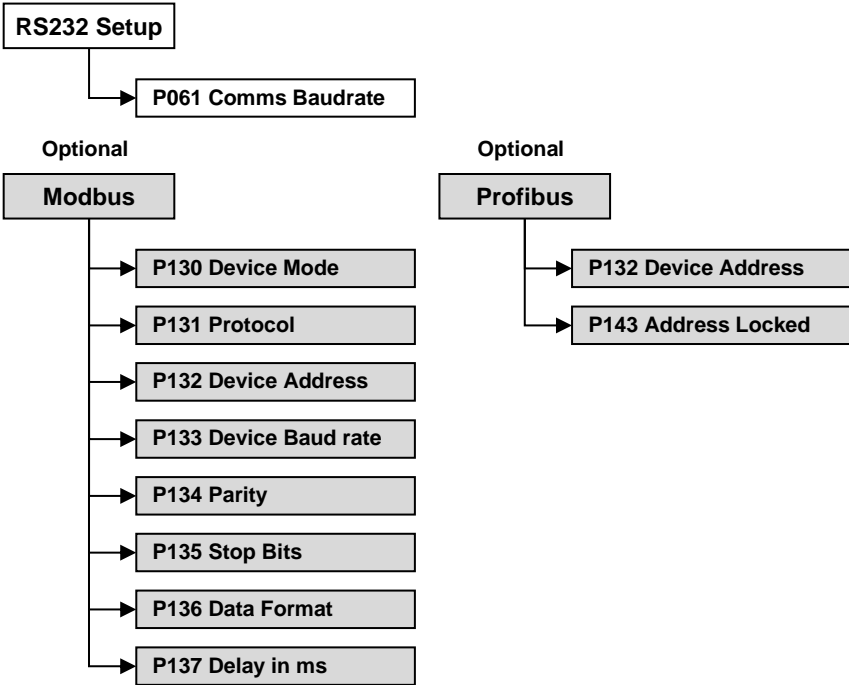
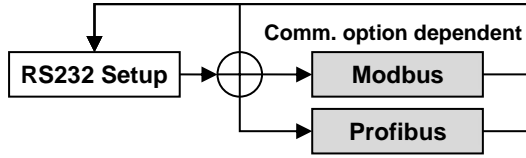

*Test Menu*

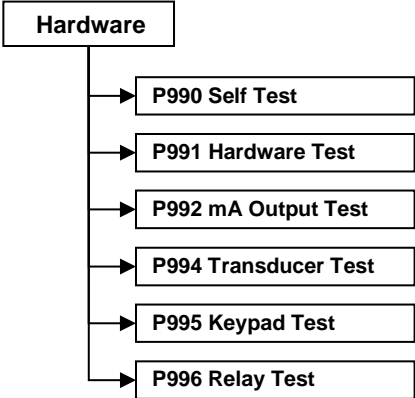
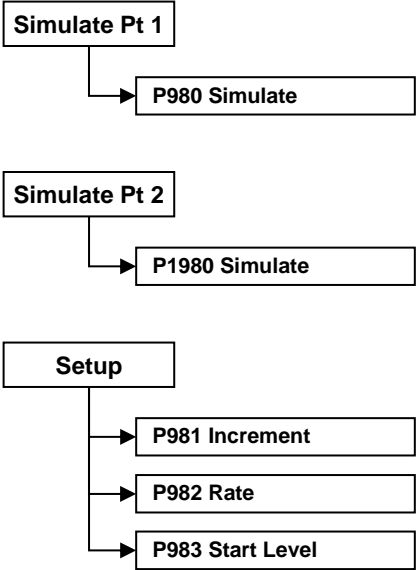
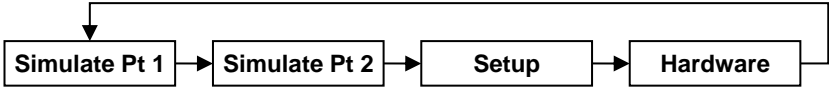

## CHAPTER 7 PARAMETER LISTING AND DESCRIPTION

### Application Parameters

#### Point 1 / Point 2

##### *P1-100, P2-1100 Mode of Operation*

This parameter sets the mode of operation, when in run mode, and can be set to one of the following:

OPTION	DESCRIPTION
<b>1 = Distance (Default)</b>	Display shows the distance from the transducer face to the surface of the material measured.
2 = Level	Shows how full a vessel is.
3 = Space	Shows how empty a vessel is.
4* = Average Level P1 & P2	Display shows the average level of point 1 & point 2
5* = Differential P1 & P2	Display shows the differential between point 1 & point 2

\*If transducer 2 is enabled

##### *P1-101, P2-1101 Xducer (Transducer)*

This parameter should be set to the transducer being used with the unit, and can be set to one of the following:

OPTION	DESCRIPTION
0 = None	<b>For point 2 only. Disables point 2 (Default)</b>
1 = dB3	Transducer is a dB3. Range = 0.125 to 3 metres
2 = dB6	Transducer is a dB6. Range = 0.3 to 6 metres
3 = dB10	Transducer is a dB10. Range = 0.3 to 10 metres
4 = dB15	Transducer is a dB15. Range = 0.5 to 15 metres
5 = dB25	Transducer is a dB25. Range = 0.6 to 25 metres
6 = dB40	Transducer is a dB40. Range = 1.2 to 40 metres
<b>7 = VT10 (Default)</b>	Transducer is a VT10. Range = 0.3 to 10 metres
*8 = ST10	Transducer is a ST10. Range = 0.3 to 10 metres

**\*This option is only available in firmware versions 2.2.0 and greater**

*P1-102, P2-102 Material*

This parameter should be set to the type of site being monitored for Sludge or the material being monitored with air transducers. The options are:

**VT/ST Transducer**

OPTION	DESCRIPTION
1 = Industrial	Use for the majority of non-sludge sites
<b>2 = Primary (Default)</b>	Use for primary settlement tanks
3 = Secondary	Use for secondary settlement tanks
4 = SBR	Use for SBR (Sequencing Batch Reactor) tanks

**dB Transducers**

OPTION	DESCRIPTION
1 = Industrial	Use for the majority of non-sludge sites
<b>2 = Primary (Default)</b>	Use for primary settlement tanks

*P1-P105, P2-P1105 Empty Level (dB transducers only)*

This parameter is to be set to the **maximum distance** from the face of a dB transducer to the **empty point** (bottom of tank), in **P104 Measurement Units**. This value also affects span, (see important information below), so should be set before span. With sludge transducers, the empty level is automatically calculated from **P115 Tank Depth** and **P116 Transducer Depth**.

*P1-P106, P2-P1106 Span*

This parameter should be set to the **maximum distance** from the **Tank Depth (P115/P1115)** or **Empty Level (P105/P1105)** to the maximum material level. It is automatically set to be equal to the **Tank Depth (P115/P1115)** or **Empty Level (P105/P1105)** less the **Near Blanking distance (P107/P1107)** when you set the tank depth or empty level.

**Important Notice**

When changing the Tank Depth (P115) or Empty Distance (P105) you can also recalculate the values for the Span and the Relay Setpoints to take in to account the near blanking (P107) and transducer depth (P116) where applicable, so that they remain at the same percentage values of the empty distance as they were before they were changed. The question "Recalculate Span?" will be asked, if you choose yes (enter), then the span will be recalculated, any other answer will leave the span at its original value. You will then be asked if you want to "Recalculate Setpoints?", if you choose yes (enter), then all Relay Setpoints will be recalculated as a percentage of the new empty distance, any other answer will leave the setpoints at their original values.

*P1-107, P2-1107 Near Blanking*

This parameter is the distance from the face of the transducer that is not measurable and is pre-set to the minimum value dependant on the **Transducer (P101)** selected. It should not be set to less than this figure, but can be increased, typically to ignore close in obstructions.

TRANSDUCER	NEAR BLANKING DISTANCE
P101/P1101 = dB3	Default blanking distance = 0.125 metres
P101/P1101 = dB6	Default blanking distance = 0.30 metres
P101/P1101 = dB10	Default blanking distance = 0.30 metres
P101/P1101 = dB15	Default blanking distance = 0.50 metres
P101/P1101 = dB25	Default blanking distance = 0.60 metres
P101/P1101 = dB40	Default blanking distance = 1.20 metres
P101/P1101 = VT10	Default blanking distance = 0.30 metres
*P101/P1101 = ST10	Default blanking distance = 0.30 metres

**\*This option is only available in firmware versions 2.2.0 and greater.**

*P1-108, P2-1108 Far Blanking Distance*

This is the distance (as a **percentage of empty level P105**) beyond the empty point that the unit will be able to measure, and by **default** is pre-set to **20%** of the empty level.

If the surface being monitored can extend beyond the **Empty Level (P105)** then the far blanking distance can be increased to a maximum of 100% of empty level.

This parameter is always entered as a % of empty level.



*P1-115, P2-P1115 Tank Depth*

This is the distance from the top of the tank (or the surface of the liquid when full) to the bottom of the tank in **P104 Measurement Units**. This parameter will only become available when a sludge transducer (prefixed 'VT') is selected in **P101 Transducer Type**.

*P1-116, P2-P1116 Transducer Depth*

This is the distance from the top of the tank (or the surface of the liquid when full) to the face of the sludge transducer in **P104 Measurement Units**. This parameter will only become available when a sludge transducer (prefixed 'VT') is selected in **P101 Transducer Type**.

**Global***P104 Measurement Units*

This parameter sets the units you want to use for programming and display.

OPTION	DESCRIPTION
<b>1 = metres (Default)</b>	All units of measurement are <b>Metres</b>
2 = cm	All units of measurement are <b>Centimetres</b>
3 = mm	All units of measurement are <b>Millimetres</b>
4 = feet	All units of measurement are <b>Feet</b>
5 = inches	All units of measurement are <b>Inches</b>

### **Relay Parameters**

All relay related parameters are prefixed with a **2\*\***.

The second digit of the three-figure parameter number denotes the relay number as follows:

**21\*** parameters for Relay **1**

**22\*** parameters for Relay **2**

**23\*** parameters for Relay **3**

**24\*** parameters for Relay **4**

**25\*** parameters for Relay **5**

**26\*** parameters for Relay **6**

The third digit selects specific parameter for the setting of the relays, which can be selected individually and results in the following parameter numbers for each relay:

Relay 1    **210** to **218**

Relay 2    **220** to **228**

Relay 3    **230** to **238**

Relay 4    **240** to **248**

Relay 5    **250** to **258**

Relay 6    **260** to **268**

*P210, 220, 230, 240, 250, 260 - Relay Type*

This parameter defines what type each relay should be, see the table below for available options:

OPTION	DESCRIPTION
1 = Alarm	Relay is programmed as an alarm relay, which will <b>de-energise ON</b> , and <b>energise OFF</b> . This will ensure an alarm is raised if the power fails to the unit.
2 = Control	Relay is programmed as a control relay, which will <b>energise ON</b> , and <b>de-energise OFF</b> .
3 = Miscellaneous	Relay is programmed as a miscellaneous relay, which will <b>energise ON</b> , and <b>de-energise OFF</b> .

## Alarms

### P210, 220, 230, 240, 250, 260 = 1 (Alarm)

The **second parameter** for each relay determines the **function** of the alarm.

*P211, 221, 231, 241, 251, 261 – Relay Function*

OPTION	DESCRIPTION
<b>0 = Off (Default)</b>	Relay will not operate.
1 = Level	Alarm is based on the level in the vessel, and the type of level alarm (P212, 222, 232, 233, 243, 253) and two setpoints must be set (P223, 223, 233 & 214, 224, 234, 244, 254). Setpoints are entered in display units or % of span as referenced to empty level.
3 = Temperature	Alarm is based on the temperature, and the type of temperature alarm (P212, 222, 232, 242, 252) and two setpoints must be set (P213, 223, 233 & P214, 224, 234, 244, 254). The temperature used depends on the temperature source selected (P852). Setpoints are entered in °C.
4 = Loss of Echo	Alarm is raised if the <b>Failsafe Timer (P809)</b> expires. No setpoints required.
5 = Loss of Clock	Alarm is raised if the expires. No setpoints required.
*6 = High Floc Alarm	An alarm is raised if the floc level reaches the level of intrusion as set in <b>% intrusion P1-163</b> .
**7 = Service Alarm	An alarm is raised when the unit has reached its service interval (see service manual for details)

***\*This is only available in units with firmware version 1.1.0 or greater.***

***\*\*This is only available in units with firmware version 1.1.1 or greater.***

The **third parameter** for each relay determines **the alarm ID** for the relay you wish to set.

*P212, P222, P232, P242, P252, P262 - Relay Alarm ID*

### When P211, 221, 231, 241, 251, 261 = 3 (Loss of Echo), 4 (Loss of Clock) or 5 (Wiper Fault)

This parameter has no function and will not be displayed.

**When P211, 221, 231, 241, 251, 261 = 1 (Level) or 2 (Temperature).** This parameter has no function and will not be displayed.

**P211, 221, 231, 241, 251 = 1 (Level), 2 = Rate of Change or 3 (Temp)**

This parameter defines which **alarm type**, or **identification**, the relay should respond to, as follows:

OPTION	DESCRIPTION	SETPOINTS
<b>1 = General (Default)</b>	Relay goes "ON" when the value reaches the ON setpoint and goes "OFF" when the value reaches the OFF setpoint.	P213, 223, 233, 243, 253, 263 is ON Setpoint; P214, 224, 234, 244, 254, 264 is OFF Setpoint.
2 = High	Relay goes "ON" when the value rises to the ON setpoint and goes "OFF" when the value lowers to the OFF setpoint.	ON > OFF Relay Setpoints P213, 223, 233, 243, 253, 263 and P214, 224, 234, 244, 254, 264. Setpoints can be set in any order as the unit 'knows' that you are setting a high level alarm.
3 = HiHi	Same as 2 = High, but different identifier	
4 = Low	Relay goes "ON" when the value lowers to the ON setpoint and goes "OFF" when the value rises to the OFF setpoint.	<b>ON &lt; OFF</b> Relay Setpoints P213, 223, 233, 243, 253, 263 and P214, 224, 234, 244, 254, 264. Setpoints can be set in any order as the unit 'knows' that you are setting a low-level alarm.
5 = LoLo	Same as 4 = Lo, but different identifier	

OPTION	DESCRIPTION	SETPOINTS
6 = In bounds	Relay goes "ON" if value is inside the zone between the two setpoints.	Relay Setpoints, P213, 223, 233, 243, 253 and P214, 224, 234, 244, 254 can be set in any order as the unit 'knows' that you are setting an inbounds alarm.
7 = Out of bounds	Relay goes "ON" if value is outside the zone between the two setpoints.	Relay Setpoints P213, 223, 233, 243, 253 and P214, 224, 234, 244, 254 can be set in any order as the unit 'knows' that you are setting an out of bounds alarm.

"ON" and "OFF" points. For a **high alarm**, the "ON" is set **higher than "OFF"**. For **low alarm** then "ON" is set **lower than "OFF"**. See the appropriate **alarm ID**, table (P212, 222, 232, 242, 252, 262) for further information.

**When P211, 221, 231, 241, 251, 261 = 3 (Loss of Echo), 4 (Loss of Clock) or 5 (Wiper Fault)**

These parameters have no function and will not be displayed.

**P211, 221, 231, 241, 251, 261 = 1 (Level) or 2 (Temperature)**

*P213, P223, P233, 243, 253, 263 - Relay Setpoint 1*

Determines the "ON" or "OFF" point for the alarm according to the ID selected.

*P214, P224, P234, 244, 254, 264 - Relay Setpoint 2*

Determines the "ON" or "OFF" point for the alarm according to the ID selected.

**Important Notice**

**Setpoints** are entered in values according to the **function** selected.

**Level** - entered in Display Units or % of span as referenced to Empty Level.

**Rate**

**of Change** - entered in Display Units per minute or % of span per minute.

For an alarm on an increasing level enter setpoints as a positive value, for an alarm on a decreasing level enter setpoints as a negative value.

**Temperature** -

entered in °C.

See the appropriate **alarm function**, table (P211, 221, 231, 241 and 251) for further information.

**Control****P210, 220, 230, 240, 250, 260 = 2 (Control)**

When a relay is being set up as a **control** relay, the **second parameter** that will be displayed in the menu determines its **function**.

*P211, 221, 231, 241, 251, 261 – Relay Function*

This function allows the relay to be assigned to specific **control** functions (other than alarms).

This can be used to activate devices based on elapsed time or running cycles, such as a timed rake control to keep a ram lubricated if idle for long periods.

OPTIONS	DESCRIPTION
<b>0 = Off (Default)</b>	Relay is always de-energised
1 = Time	Relay will <b>energise "ON"</b> after the <b>Cycle time</b> that is set in Relay <b>Setpoint 2</b> (P214, 224, 234, 244, 254, 264). And turns <b>"OFF", de-energises</b> , after the <b>On Time Period</b> that is set in Relay <b>Setpoint 1</b> (P213, 223, 233, 243, 253, 263)
2 = General	Control is based on the level in the vessel. All general controls are used to assist each other (run at the same time) and each general control has its own <b>"ON"</b> and <b>"OFF"</b> setpoints.

The **third parameter** has **no function** when **control relays** are chosen and will not be displayed.

The **fourth parameter** and **fifth parameter** are set to determine the switch points, "**ON**" and "**OFF**" for the relay. See **control function**, table (**P211, 221, 231, 241, 251, 261**) for further information.

*P213, P223, P233, 243, 253, 263 - Relay Setpoint 1*

**P211, 221, 231, 241, 251, 261 =1 (Time)**

This parameter determines the "**Time Period**" that the relay will remain "**ON**". Relay Setpoints are entered in Minutes.

See the appropriate relay Function tables (**P211, 221, 231, 241, 251, 261**) for further information.

**P211, 221, 231, 241, 251, 261 =2 (General)**

This parameter is the "**ON**" point for the general control relay. Relay setpoints are entered in values of Measurement Units (**P104**).

*P214, P224, P234, 244, 254, 264 - Relay Setpoint 2*

**P211, 221, 231, 241, 251, 261 =1 (Time)**

This parameter determines the "**Cycle Time**" for the operation of the relay. See the appropriate relay **Function** tables (**P211, 221, 231, 241, 251, 261**) for further information.

**P211, 221, 231, 241, 251, 261 =2 (General)**

This parameter is the "**OFF**" point for the general control relay. Relay setpoints are entered in values of Measurement Units (**P104**).



## Miscellaneous

### P210, 220, 230, 240, 250, 260 = 3 (Miscellaneous)

When a relay is set to be a **miscellaneous relay**, the **second parameter** determines its **function**.

#### *P211, 221, 231, 241, 251, 261 – Relay Function*

This function allows the relay to work in relation to a clock or a specific event and will be set to activate in relation to Real Time.

OPTIONS	DESCRIPTION
<b>0 = Off (Default)</b>	Relay is always de-energised
1 = Clock	Relay will <b>energise ON</b> at a specified time each day as set in Relay Setpoint 1 (P213, 223, 233, 243, 253). And turns <b>OFF, de-energises</b> , after the specified-On Time period as set in Relay Setpoint 2 (P214, 224, 234, 244, 254)

### Important Notice

When using a Relay to control a device at a specified time of day ensure that the **Time P932** is set correctly. And if required, enable **Daylight Saving** for the appropriate time difference **P970 – P979**.

The **third parameter** has **no function** when **miscellaneous relay** is chosen and will not be displayed.

The **fourth parameter**, and **fifth parameter**, are set to determine the switch points, "**ON**" and "**OFF**" for the relay. See **miscellaneous** function table (**P211, 221, 231, 241, 251, 261**) for further information.

### P210, 220, 230, 240, 250, 260 = 1 (Clock)

#### *P213, 223, 233, 243, 253, 263 – Relay Setpoint 1*

Relay Setpoints are entered in Hours & Minutes (HH:MM) to set Time at which relay will energise. Default = **00:00 (HH:MM)**

#### *P214, 224, 234, 244, 254, 264 – Relay Setpoint 2*

Relay Setpoints are entered in seconds to set the **Time Period** that the relay will remain 'ON'. **Default = 0.00 mins.**

**Common Parameters**

*P216, 226, 236, 246, 256, 266 – Relay Allocation*

This parameter determines which input the relay will act on. You can set it to the transducer1 (default), transducer 2 or an average, sum, or differential of the two when available.

OPTIONS	DESCRIPTION
<b>1 = Xducer 1 (Default)</b>	Relay acts on Xducer 1 calculated values
2 = Xducer 2	Relay acts on Xducer 2 calculated values
3 = Average of 1 & 2	Relay acts on the resulting average levels of two signal inputs.
4 = Differential of 1 & 2	Relay acts on the resulting differential level of two signal inputs

*P217, P227, P 237, P247, P257, 267 - Relay Closures*

The SludgeFinder 2 will record how many times each relay is closed, this parameter displays the number of times the relay has activated since the relay has been in use. It can be reset with any value.

*P218, P228, P238, P248, P258, 268 - Relay Fail Safe*

Your SludgeFinder 2 has a general fail-safe parameter **P808**. However, this can be overridden so that each individual relay has its own independent failsafe mode.

This parameter determines what the relay will do in the event of the Failsafe Time (P809) expiring.

OPTIONS	DESCRIPTION
<b>0 = Default</b>	Relay assumes system default mode P808
1 = Hold	Relay remains in its current state
2 = De-energise	Relay will De-energise
3 = Energise	Relay will energise

### **Floc Alarm Parameters**

#### *P1-160, P2-1160 Start Distance*

This parameter determines in measurement units (P104) the distance from the transducer at which the Floc Density monitoring starts.

Minimum = 0, Maximum = 10. **Default = 0m**

#### *P1-161, P2-1161 End Distance*

This parameter determines in measurement units (P104) the distance from the transducer at which the Floc Density monitoring ends.

Minimum = 0, Maximum = 10. **Default = 0m**

#### *P1-162, P2-1162 Level*

This sets the level above which the Floc Density is considered too high. The level is in dB (decibels) as on the trace display of the unit.

Minimum = 0, Maximum = 99.9. **Default = 50dB**

#### *P1-163, P2-1163 % of intrusion*

Use this parameter to set the percentage of the distance between the Start distance and the End distance that must have a trace above Level to trigger an alarm.

Minimum = 0, Maximum = 100. **Default = 100%**

#### *P1-164, P2-1164 On Delay*

This parameter sets the time, in minutes, from when the Floc Density becomes too high until the alarm is activated.

Minimum = 0, Maximum 10. **Default = 0mins**

#### *P1-165, P2-1165 Off Delay*

This parameter sets the time, in minutes, from when the Floc Density becomes low again until the alarm is deactivated.

Minimum = 0, Maximum = 10. **Default = 0mins**

### ***Service Interval Alarm Parameters***

Please contact Pulsar for further information.

### ***Data Log Parameters***

The data log parameters contain the following information.

#### **Point 1 / Point 2**

The following parameters give information on temperature conditions seen by the Temperature source (**P852/P1852**) in °C. All these parameters are read only and cannot be changed, though if **P852/P1852** is changed they will be reset.

#### ***P1-P580, P2-P1580 Minimum Temperature***

This parameter displays the minimum temperature recorded.

#### ***P1-P581, P2-P1581 Minimum Temperature Date***

This parameter displays the date when the minimum temperature was recorded.

#### ***P1-P582, P2-P1582 Minimum Temperature Time***

This parameter displays the time when the minimum temperature was recorded.

#### ***P1-P583, P2-P1583 Maximum Temperature***

This parameter displays the maximum temperature recorded.

#### ***P1-P584, P2-P1584 Maximum Temperature Date***

This parameter displays the date when the maximum temperature was recorded.

#### ***P1-P585, P2-P1585 Maximum Temperature Time***

This parameter displays the time when the maximum temperature was recorded.

#### ***P1-P586, P2-P1586 Current Temperature***

This parameter displays the current temperature.

## Display Parameters

### Point 1 / Point 2

#### *P1-800, P2-1800 Display Units*

This parameter determines whether the reading displayed is in **Measurement Units (P104)**, or as a **percentage of span**.

OPTION	DESCRIPTION
<b>1 = Measured (Default)</b>	Display is in selected unit's dependent in Mode <b>(P100/P1100)</b>
2 = Percentage	Display is in <b>percentage</b> of span dependent in Mode <b>(P100/P1100)</b>

#### *P1-801, P2-1801 Decimal Places*

This parameter determines the number of decimal places on the reading during run mode. Minimum = 0 (No decimal places), Maximum 3 = (3 decimal Places). **Default = 2** (2 decimal Places).

#### *P1-802, P2-1802 Display Offset*

The value of this parameter is added to the reading before it is displayed, in **Measurement Units (P104)**. It does not affect the relay setpoints or the mA output, only the reading on the display.

You could use this feature if for example you wanted to reference the reading to sea level, where you would enter the distance between **Empty Level (P105)** and sea level. If the empty level point is below sea level, then enter a negative value.

#### *P1-804, P2-1804 Display Conversion*

The reading is multiplied by the value of this parameter before being displayed. The default is 1.0, but if for example you wanted to display the reading in yards, then set the **Measurement Units (P104)** to feet and set **P804** to 3.

## Failsafe

### *P1-808, P2-1808 Failsafe Mode*

By default, if a fail-safe condition occurs, then the display, relays and the mA output are held at their last **known** values until a valid reading is obtained.

If required, then you can change this so that the unit goes to **high** (100% of span), or **low** (empty) as follows:

OPTION	DESCRIPTION
<b>1 = Known (Default)</b>	Remain at its last <b>known</b> value
2 = High	Will fail to the <b>high</b> value (100% span)
3 = Low	Will fail to the <b>low</b> value (empty)

— See Also *P218, P228, P238, P248, P258, 268 - Relay Fail-safe and P840 mA Output Fail-safe*

### Important Notice

In the event of a **fail-safe** condition occurring, the display, relays and mA Output can be configured to fail to a condition which is independent of each other. To set independent Relay Failsafe see **P218, 228, 238, 248, 258, 268**. And for independent **mA Output Failsafe** see **P840/P898**.

### *P1-809, P2-1809 Failsafe Time*

In the event of a failsafe condition the failsafe timer determines the time before failsafe mode is activated. **Default = 2mins**

If the timer activates, the unit goes into **failsafe**, as determined by **P808/P1808 (Display), P218, 228, 238, 248, 258, 268 (Relays)** and **P840/P898 (mA Output)**. When this happens, you will see the message "**Failed Safe!**" on the display, along with a message explaining why (lost echo or transducer fault, for example).

When a valid measurement is obtained then the display, relays and mA output will be restored, and the timer is reset.

### *P823 Totaliser Multiplication Factor*

This parameter determines the number of decimal places in the totaliser during run mode. It can be set between 1 and 3. **Default = 2**

## **mA Out 1 / mA Out 2 Parameters**

### *P1-830, P2-1830 mA Range*

This parameter determines the range of the mA output, from the following:

<b>OPTION</b>	<b>DESCRIPTION</b>
0 = Off	mA output disabled
1 = 0 to 20 mA	mA output directly proportional to the <b>mA mode (P831,891)</b> , so if the reading is 0% the output is 0 mA. If the reading is 100% the output is 20 mA.
<b>2 = 4to 20 mA (Default)</b>	mA output directly proportional to the <b>mA mode (P831,891)</b> , so if the reading is 0% the output is 4 mA. If the reading is 100% the output is 20 mA.
3 = 20 to 0 mA	mA output inversely proportional to the <b>mA mode (P831,891)</b> , so if the reading is 0% the output is 20 mA. If the reading is 100% the output is 0 mA.
4 = 20 to 4 mA	mA output inversely proportional to the <b>mA mode (P831,891)</b> , so if the reading is 0% the output is 20 mA. If the reading is 100% the output is 4 mA.

### *P1-831, P2-1891 mA Mode*

This parameter determines how the mA Output relates to what is measured. By **default**, it operates the same as the display (**P100/P1100**), but it can be set to operate as follows:

<b>OPTION</b>	<b>DESCRIPTION</b>
<b>0 = Default</b>	mA output relative to <b>Mode P100/P1100</b>
1 = Distance	mA output relative to <b>Distance</b> .
2 = Level	mA output relative to <b>Level</b> .
3 = Space	mA output is relative to <b>Space</b> .
4* = Average Level	mA output is relative to the <b>Average level</b> .
5* = Differential	mA output is relative to <b>Differential level</b>

### **Setpoint**

By **default**, the mA Output will represent the **empty (0 or 4mA)** dependant on (**P830/P890 mA Range**) and **100%** of the operational **span (20mA)**, but you may wish to have the output represent a section of the operational span. For example, the application has an operational span of 6 metres, but **output** is to **represent empty (0 or 4mA)** dependant on (**P830/P890 mA Range**) to a **level of 5 metres (20mA)**. If so P834 (Low Level) should be set to 0.00 metres and P835 (High Level) should be set to 5 metres.

#### *P1-834, P2-892 mA Low Level*

This parameter sets the level, distance, or space, depending on the selected **mA Out Mode (P831/891)** at which the low mA output will occur (**0 or 4mA** dependant on (**P830/890 mA Range**)). **Default = 0.000m**

#### *P1-835, P2-893 mA High Level*

This parameter sets the level, distance or space, depending on the selected **mA Out Mode (P831/891)** at which the high mA output will occur (**20mA**). **Default = 6.00m**

#### *P1-836, P2-894 mA Low Limit*

This parameter sets the lowest level that the mA output will drop to, the default is 0mA, but you can override this if the device you connect to cannot for example accept less than 2mA, yet you want to use the 0-20mA range. **Default = 0.00mA**

#### *P1-837, P2-895 mA High Limit*

This parameter sets the highest level that the mA output will rise to, the default is 20 mA, but you can override this if the device you connect to cannot for example accept more than 18 mA, yet you want to use the 0-20 mA range. **Default = 20.00mA**

#### *1-P838, P2-896 mA Low Trim*

If the device you are connected to is not calibrated, and not showing the correct **low value** (reading), then you can trim it using this parameter. You can either type in the offset directly or use the arrow keys to move the output up and down until you get the expected result (reading) on the device that is connected.



*P1-839, P2-897 mA 1 High Trim*

If the device you are connected to is not calibrated, and not showing the correct **high value** (reading), then you can trim it using this parameter. You can either type in the offset directly or use the arrow keys to move the output up and down until you get the expected result (reading) on the device that is connected.

*P1-840, P2-898 mA Failsafe Mode*

This parameter determines what happens to the mA output in the event of the unit going into fail-safe mode. The **default** is to do the same as the **system fail-safe (P808)**, but this can be overridden to force the mA output to an independent fail-safe mode as follows:

OPTION	DESCRIPTION
<b>0 = Default</b>	mA output will fail as per <b>P808/P1808</b>
1 = Hold	mA output will retain its last known value.
2 = Low	mA output will fail to its <b>low</b> condition.
3 = High	mA output will fail to its <b>high</b> condition.

*P841 mA Allocation*

By default, the mA output will be representative of the reading obtained, as determined by the **Mode P100/P1100**. When **P100/P1100 = 4 (Average)** or **5 (Differential)** the mA output can be assigned to be representative of the **level** of either of the two points of measurement. This parameter is automatically set to the correct default option when selecting the **Mode P100/1100** and **Xducer (P101/P1101)**, and under normal circumstances will not require changing.

The options, dependant on the **value** entered for **Mode P100/P1100**, are as follows:

OPTION	DESCRIPTION
<b>1 = Xducer 1 (Default P1)</b>	mA output relates to Xducer 1 <b>level</b>
<b>2 = Xducer 2 (Default P2)</b>	mA output relates to Xducer 2 <b>level</b>

## Compensation Parameters

### Offset

#### *P1-851, P2-851 Measurement Offset*

The value of this parameter is added to the measured distance, in **Measurement Units (P104)**.

This Offset will be added to the level, as derived from the transducer, and will affect everything including the reading on the display, the relay setpoints and the mA output.

### Temperature

#### *P1-852, P2-1851 Temperature Source*

This parameter determines the source of the temperature measurement. By **default**, it is set to automatic (**P852/P1852=1**), which will automatically detect if a temperature sensor is available from the transducer. If for any reason, no temperature input is received, then the **Fixed Temp** value is used, as set by **P854/P1854**.

The temperature source can be specifically set as follows:

OPTION	DESCRIPTION
<b>1 = Automatic (Default)</b>	Will automatically select transducer temperature sensor, if available, or fixed temperature (P854) if no temperature sensor found.
2 = Xducer 1	Always uses temperature reading from transducer 1.
3 = Xducer 2	Always uses temperature reading from transducer 2.
4 = Fixed	Always uses fixed temperature (P854/P1854)

#### *P1-P854, P2-P1854 Fixed Temperature*

This parameter sets the temperature, in degrees Celsius, to be used if **P852/P1852 (Temperature Source) =3**. Default = 20°C

#### *P1-P860, P2-P1860 Sound Velocity*

This parameter allows for the velocity of sound to be changed according to the atmosphere the transducer is operating in. By default, the velocity is set for sound travelling in air/water at an ambient temperature of 20 degrees centigrade. **Default = 342.72m/s (velocity in air for dB transducer)**

**Default = 1482.32m/s (velocity in water for VT transducer)**

## Stability Parameters

### Point 1 / Point 2

#### Damping

Damping is used to damp the display, to enable it to keep up with the process but ignore minor surface fluctuations.

##### *P1-870, P1870 Fill Damping*

This parameter determines the **maximum rate** at which the unit will respond to an **increase in level**. It should be set slightly higher than the maximum vessel fill rate. **Default = 10m/min.**

##### *P1-871, P2-1871 Empty Damping*

This parameter determines the **maximum rate** at which the unit will respond to a **decrease in level**. It should be set slightly higher than the maximum vessel empty rate. **Default = 10m/min.**

#### Filters

The following three parameters can be used to filter out unwanted changes of level caused by a 'rippled' or agitated surface.

##### *P1-881, P2-1881 Fixed Distance*

This parameter determines the width of gate to be used in tracking an echo and under normal circumstances will not require changing, but it can be increased in the cases where the surface is moving extremely fast (in excess of 10m/min) to ensure smooth processing of the changing level.

##### *P1-882, P2-1882 Process Filter (dB Transducers)*

This parameter determines the number of 'cycles' that will be taken before a change in level is processed and the display updated.

OPTION	DESCRIPTION
1 = Fast	level will be updated every cycle
2 = Medium	level will be updated every 8 cycles
<b>3 = Slow (Default)</b>	level will be updated every 16 cycles

*P1-883, P2-1883 Gate Expand*

This parameter determines the size of the increment by which the gate expands per cycle when an echo is detected outside of the gate.

**Default = 0.1m**

**Echo Processing Parameters**

**Point 1 / Point 2**

**Transducer 1 Status**

*P1-900, P2-910 Transducer Status*

This parameter shows the current state of the transducer. The value means the following:

OPTION	DESCRIPTION
0= OK	Transducer working correctly.
1= Disabled	Transducer is not being used (mA input is being used instead, so P101=1)
2= Stuck High	Indicates that the power and signal lines on the transducer terminals are crossed over, or the signal line is shorted to earth.
3= Not Found	No transducer is detected.

*P1-901, P2-911 Echo Confidence 1/2*

This parameter displays the most recent echo confidence from the transducer. It is useful to help find the best mounting location for the transducer, where you should aim to get the highest figure. It is a percentage of confidence that the echo reporting the level is the correct one.

*P1-902, P2-912 Echo Strength 1/2*

This parameter displays the most recent echo strength figure for the transducer, where a higher figure indicates a better returned echo.

*P1-903, P2-913 Average Noise 1/2*

This is the mean noise reading for the transducer. It is measured while the transducer is not firing and gives an indication of the average amount of electrical noise present on the cabling.

### *P1-904, P2-914 Peak Noise 1/2*

This is the peak noise reading for the transducer. It is measured while the transducer is not firing and gives an indication of the maximum amount of electrical noise present on the cabling.

### *P1-905, P2-915 Sensitivity (dB Transducers only)*

This parameter determines the sensitivity of the unit. Please consult Pulsar for further information and assistance on changing the value of this parameter.

### *P1-906, P2-916 Side Clearance (dB Transducers only)*

This parameter is used to set the distance by which the DATEM trace will "stand-off" from around unwanted echoes such as obstructions. Please consult Pulsar for further information and assistance on changing the value of this parameter. **Default 5dB (50mV)**

## ***Transducer 2 Status***

**When Ultra Wizard = 1 Level/Volume or 2 Pump/Differential**

### *P910 - 916 Transducer 2*

These parameters contain the same information as detailed in Transducer 1 Status, for Transducer 2.

## System Parameters

### Passcode

#### *P921 Enable Code*

**Enables** the passcode (**P922**), which means the passcode must be entered to go into program mode. If **disabled** (set to **0**), then no passcode is required, and ENTER is used to enter program mode. **Default = 1 (Enabled)**

#### *P922 Passcode*

This is the passcode that must be used to enter program mode. The **default** is **1997**, but this can be changed to another value from 0 to 9999.

### Backup

#### *P925 Parameter Backup & Restore*

This parameter is used to make a backup of all parameters, for example to ensure a default set is maintained within the unit. If alterations are made to the parameters that do not work as intended, then the backup set can be restored into the unit.

You can make two separate backup copies if you wish, called backup 1 and backup 2, and restore from either. The options are:

OPTION	DESCRIPTION
1= Backup 1	Make backup to area 1 of all parameters
2= Backup 2	Make backup to area 2 of all parameters
3= Restore 1	Restore all parameters from area 1
4= Restore 2	Restore all parameters from area 2

### **System Information**

*The following three parameters do not affect how the unit performs, but details, contained in them, may be required, by Pulsar, when making technical enquiries.*

#### *P926 Software Revision*

This parameter will display the current software revision. It is read only and cannot be changed.

#### *P927 Hardware Revision*

This parameter will display the current hardware revision. It is read only and cannot be changed.

#### *P928 Serial Number*

This parameter will display the serial number of the unit. It is read only and cannot be changed.

#### *P929 Site Identification*

This parameter allows you to give each unit an individual reference number, for identification purposes. You can set any number between 1 and 99999.

#### *P930 Factory Defaults*

This parameter resets all parameter values to the original Factory Set values that were installed when the unit was tested before despatch to you.

To reset parameters, enter **1 (Yes)**, and press ENTER, then you will see a message "Entr if sure", you should press ENTER again. If you press any other key at this point, the parameters will not be reset, and you will see a message confirming this.

Once you have done this, program the unit, to the desired application.

## **Date & Time**

The date and time is used, to control specific relay functions and date stamp certain events that are contained in the Data Logs. It is also used in conjunction with the system watchdog that keeps an eye on the times the unit has started.

### *P931 Date*

This parameter displays the **current date**, in the format as set by **P933 (Date Format)** and can be reset if required.

### *P932 Time*

This parameter displays the **current time** and can be reset if required, in the format HH: MM (24-hour format). This is set initially at the factory for UK time.

### *P933 Date Format*

This parameter allows you to alter the format that the date is displayed to your choice of DD: MM: YY, MM: DD: YY or YY: MM: DD. The default is DD: MM: YY.

## **LED Colour**

Each relay has an associated LED, located on the unit's front panel, which indicates the status of the relay. By default, the LED of any relay that has been programmed but is in its "OFF" state will be illuminated 'yellow'. When "ON" **alarm** relays will cause the **LED** to illuminate **Red** and **pump, control** and **miscellaneous** relays will cause the **LED** to illuminate **green**. LED's of any relays that have not been programmed will not be illuminated. Customised settings for the colour of LED's can be achieved by using the following parameters.

### *P935 Off Relay Colour*

This parameter selects the colour that a **programmed relay** should be when it is in its "OFF" state. The **default** is **3 = yellow**, but can be changed to 'no colour', red or green.

### *P936 Alarm Relay Colour*

This parameter selects the colour that an **alarm** relay should be when it is in its "ON" state. The **default** is **1 = red**, but can be changed to 'no colour', green or yellow.



### *P937 Pump Relay Colour*

This parameter selects the colour that a **pump** relay should be when it is in its "ON" state. The **default is 2 = green**, but can be changed to 'no colour', red or yellow.

### *P938 Control Relay Colour*

This parameter selects the colour that a **control** relay should be when it is in its "ON" state. The **default is 2 = green**, but can be changed to 'no colour', red or yellow.

### *P939 Miscellaneous Relay Colour*

This parameter selects the colour that a **miscellaneous** relay should be when it is in its "ON" state. The default is **2 = green**, but can be changed to 'no colour', red or yellow.

All relays that are not programmed will show, 'no colour', i.e. they are off.

## **Watchdog**

You can check how many times the unit has been switched on, and look at the date and time of the last ten starts. This can be useful if there have been power failures or if for any reason the Sludge Finder 2 restarts due to a fault condition. The Sludge Finder 2 can be backed up from a battery which automatically cuts in during power failure. Battery backed up units will continue uninterrupted operation and therefore will not register a loss of mains power. If, however, the battery was to fail during a mains power interruption, a start up would be recorded once power has been restored.

### *P940 Number of Starts*

This parameter shows how many times the unit has been powered up.

### *P941-P960 Start Date & Time*

Parameters **P941** and **P942** show the **date** and **time** that the unit was last started. There are **ten start dates & times** recorded, which are parameters **P943-P960**. The first on the list are the most recent, and the last ones are the oldest. These are read only and cannot be changed.

## **Daylight Saving Time**

### *P970 DST Enable*

#### **Important Notice**

To ensure the correct operation of Daylight-Saving Time P932 Time should be checked, and adjusted if necessary, to ensure that it is set for the current valid time.

When **Enabled** (set to **1**) the internal clock will be automatically adjusted to compensate for the difference between standard time and **Daylight-Saving Time**. **Default = 1 (Yes)**

### *P971 DST Difference*

This parameter sets the time difference between standard time and **Daylight-Saving Time**. The time difference is entered in HH:MM. **Default = 01:00**

### *P972 DST Start Time*

This parameter is used to set the **time** of day at which **Daylight-Saving Time** will **start**, the time is entered in the format HH: MM (24-hour format). **Default = 02:00**

*P973 Start Day*

Use this parameter to enter the **day** of the week (**P974**) that **Daylight Saving Time** is to **start**.

OPTION	DESCRIPTION
2= Monday	DST will <b>start</b> on a <b>Monday</b>
3= Tuesday	DST will <b>start</b> on a <b>Tuesday</b>
4= Wednesday	DST will <b>start</b> on a <b>Wednesday</b>
5= Thursday	DST will <b>start</b> on a <b>Thursday</b>
6= Friday	DST will <b>start</b> on a <b>Friday</b>
7= Saturday	DST will <b>start</b> on a <b>Saturday</b>
<b>8= Sunday (Default)</b>	DST will <b>start</b> on a <b>Sunday</b>

*P974 Start Week*

This parameter will determine the **week** of the month (**P975**) in which **Daylight-Saving Time** is to **start**.

OPTION	DESCRIPTION
1= Week 1	DST will <b>start</b> on <b>day (P973)</b> in the <b>first</b> week ( <b>P974</b> ) of the <b>month (P975)</b> .
2= Week 2	DST will <b>start</b> on <b>day (P973)</b> in the <b>second</b> week ( <b>P974</b> ) of the <b>month (P975)</b> .
3= Week 3	DST will <b>start</b> on <b>day (P973)</b> in the <b>third</b> week ( <b>P974</b> ) of the <b>month (P975)</b> .
4= Week 4	DST will <b>start</b> on <b>day (P973)</b> in the <b>fourth</b> week ( <b>P974</b> ) of the <b>month (P975)</b> .
<b>5= Last (Default)</b>	DST will <b>start</b> on <b>day (P973)</b> in the <b>last</b> week ( <b>P974</b> ) of the <b>month (P975)</b> .

*P975 Start Month*

This parameter is used to select the **month**, in which **Daylight-Saving Time** will **start**.

OPTION	DESCRIPTION
1= January	<b>DST will start</b> during the month of <b>January</b>
2= February	<b>DST will start</b> during the month of <b>February</b>
<b>3= March (Default)</b>	<b>DST will start</b> during the month of <b>March</b>
4= April	<b>DST will start</b> during the month of <b>April</b>
5= May	<b>DST will start</b> during the month of <b>May</b>
6= June	<b>DST will start</b> during the month of <b>June</b>
7= July	<b>DST will start</b> during the month of <b>July</b>
8= August	<b>DST will start</b> during the month of <b>August</b>
9= September	<b>DST will start</b> during the month of <b>September</b>
10= October	<b>DST will start</b> during the month of <b>October</b>
11= November	<b>DST will start</b> during the month of <b>November</b>
12= December	<b>DST will start</b> during the month of <b>December</b>

*P976 DST End Time*

This parameter is used to set the **time** of day at which **Daylight-Saving Time** will **end**, the time is entered in the format HH: MM (24-hour format). **Default = 02:00.**

*P977 DST End Day*

Use this parameter to enter the **day** of the week (**P974**) that **Daylight Saving Time** is to **end**.

OPTION	DESCRIPTION
2= Monday	DST will <b>end</b> on a <b>Monday</b>
3= Tuesday	DST will <b>end</b> on a <b>Tuesday</b>
4= Wednesday	DST will <b>end</b> on a <b>Wednesday</b>
5= Thursday	DST will <b>end</b> on a <b>Thursday</b>
6= Friday	DST will <b>end</b> on a <b>Friday</b>
7= Saturday	DST will <b>end</b> on a <b>Saturday</b>
<b>8 = Sunday (Default)</b>	DST will <b>end</b> on a <b>Sunday</b>

*P978 End Week*

This parameter will determine the **week** of the month (**P975**) in which **Daylight-Saving Time** is to end.

OPTION	DESCRIPTION
1= Week 1	DST will <b>end</b> on <b>day (P973)</b> in the <b>first</b> week ( <b>P974</b> ) of the <b>month (P975)</b> .
2= Week 2	DST will <b>end</b> on <b>day (P973)</b> in the <b>second</b> week ( <b>P974</b> ) of the <b>month (P975)</b> .
3= Week 3	DST will <b>end</b> on <b>day (P973)</b> in the <b>third</b> week ( <b>P974</b> ) of the <b>month (P975)</b> .
4= Week 4	DST will <b>end</b> on <b>day (P973)</b> in the <b>fourth</b> week ( <b>P974</b> ) of the <b>month (P975)</b> .
<b>5= Last (Default)</b>	DST will <b>end</b> on <b>day (P973)</b> in the <b>last</b> week ( <b>P974</b> ) of the <b>month (P975)</b> .

*P979 End Month*

This parameter is used to select the **month**, in which **Daylight-Saving Time** will **end**.

OPTION	DESCRIPTION
1= January	<b>DST will end</b> during the month of <b>January</b>
2= February	<b>DST will end</b> during the month of <b>February</b>
3=March	<b>DST will end</b> during the month of <b>March</b>
4= April	<b>DST will end</b> during the month of <b>April</b>
5= May	<b>DST will end</b> during the month of <b>May</b>
6= June	<b>DST will end</b> during the month of <b>June</b>
7= July	<b>DST will end</b> during the month of <b>July</b>
8= August	<b>DST will end</b> during the month of <b>August</b>
9= September	<b>DST will end</b> during the month of <b>September</b>
<b>10= October (Default)</b>	<b>DST will end</b> during the month of <b>October</b>
11= November	<b>DST will end</b> during the month of <b>November</b>
12= December	<b>DST will end</b> during the month of <b>December</b>

*Device Comm.*

*RS232 Set Up*

*P061 Comms Baud*

This parameter is used to set the speed (Baud Rate) of the RS232 communications and can be changed to suit the connecting device.

**Default = 19200**

*RS 485 Set Up*

Please refer to the RS485 communications manual for availability of parameters and details of their options. This can be found in the downloads section of the Pulsar website:

<https://pulsarmeasurement.com/downloads/instruction-manuals/>

## Test Parameters

### Simulation

#### *P980 Simulate*

Test mode is used to simulate the application and confirm that all parameters and relay setpoints have been entered as expected. During simulation, there is a choice of whether the relays will change state (hard simulation) or not (soft simulation), but the LED's will always change colour as programmed, and the current output will change. If you want to test the logic of the system that the relays are connected to then select a hard simulation, but if you do not want to change the relay state, then select a soft simulation.

There are two simulation modes, **automatic** and **manual**. Automatic simulation will move the level up and down between empty level or the pre-determined **Start Level (P983)** and Pump/Control relay switch points, if you wish to change the direction of the level movement e.g. to go beyond relay setpoints, this can be done by using the arrow keys. In manual simulation, using the arrow keys will allow you to move the level up and down as required.

The choices for you to enter are as follows.

- 1= Manual soft simulation
- 2= Automatic soft simulation
- 3= Manual hard simulation
- 4= Automatic hard simulation

Whilst in Automatic hard simulation (**P980 = 4**) the switching of digital inputs can be simulated by pressing the corresponding numeric key to the input to be switched, each time the numeric key is pressed it will toggle the input between On and Off.

To return to program mode, press 'CANCEL' and test mode will end.

#### *P981 Increment*

By **default**, simulation mode will move by **0.1m** steps in manual simulation and by **0.1m/min** in automatic simulation. Altering the increment can change this value.

### *P982 Rate*

In automatic mode, the rate at which the level will move up and down, is determined by distance, **P981 Increment** and the time, **P982 Rate** which by **default** is set to **1min** and can be changed as required. To increase the rate at which the level moves increase the **Increment (P981)** or decrease the **Rate (P982)**. To decrease the rate at which the level moves decrease the **Increment (P981)** or increase the **Rate (P982)**.

### *P983 Start Level*

When using automatic simulation this parameter can be used to pre-determine the point at which the simulated level will start at and return to. This can be used to simulate the lowest point to which the level would normally operate.

## **Hardware**

### *P990 Self Test*

If you enter 1 for this parameter, then the unit will perform a self-test. This will confirm that the various parts of the circuitry are working correctly. You will see confirmation messages that the clock and the EEPROM are working correctly, and error messages for any parts that fail.



### *P991 Hard Test*

When this parameter is selected, the unit will test the following in turn.

- **LED's.** Watch them change colour as shown on the display, and press, ENTER, if they operated as shown.
- **Relays.** Press a numeric key corresponding to the number of the relay you wish to test, and the relay will change state each time the key is pressed. If you press any other key, other than a valid relay number, then the test will end.
- **Segments.** All the segments on the LCD are lit up, so you can see if they all work. Press, ENTER, to end the test. The LED's all go green at the same time.
- **Keys.** You should press each key, to confirm it works, with a counter showing how many more keys you have to press. Be sure to press the **CANCEL** key last, as this will show if all keys were pressed or not. If they were not, then an error message is displayed.

### *P992/P993 mA Out 1/2 Test*

This parameter will allow you to force a specified current on the mA output, to test the equipment that it is connected to, and to make sure the unit is working correctly. The figure you enter will be generated by the mA output.

### *P995/P996 Transducer 1/2 Test*

If you enter 1 for this parameter it will continually fire the transducer, so you can check the wiring, until you press any key to cancel.

### *P997 Keys Test*

You should press each key, to confirm it works, with a counter showing how many more keys you have to press. Press the **CANCEL** key last, as this will confirm if all keys were pressed or not. If they were not, then an error message is displayed.

### *P998 Relay Test*

Press a numeric key corresponding to the number of the relay you wish to test, and the relay will change state each time the key is pressed. If you press any other key, other than a valid relay number, then the test will end.

## CHAPTER 8 TROUBLESHOOTING

This section describes many common symptoms, with suggestions as to what to do. If the issue persists, please contact your local Pulsar distributor.

SYMPTOM	WHAT TO DO
Display blank, transducer not firing.	Check power supply, voltage selector switch and fuse.
Displays "Xducer Flt"	There is a fault with the transducer wiring, check wiring to the transducer(s).
Displays 'Failed Safe'	The transducer has not been able to lock on to a target. Check transducer wiring, check P900 status. Check to see if transducer is 'clicking', check for any obstructions in the application.
Incorrect reading being displayed for current level.	Check the trace screen for the relevant transducer. If there is an obstruction in front of the true echo, then enter Program Mode and directly access P21 (Set Distance) for xdr1 or P1021 for xdr2. Type in the distance of the true echo and press ENTER. Press ENTER again when prompted, wait until 'Operation successful' is displayed and return to Run Mode, the display should now update to correct reading.
Material level is consistently incorrect by the same amount.	Check empty level, (P105) display offset, (P802) and measurement offset (P851).
LED's change colour at relevant relay switch points but relays do not change state.	Check supply to unit and ensure voltage selector set to correct position.
Main display shows "Wiper Fault"	There is a fault with the wiper. Check transducer wiring (incl. motor terminal). Use the hotkey (F5) to initiate a manual wiper sweep. If the message is still present, then there is a problem with the wiper or motor. Remove the transducer from the application, remove any fouling and attempt a manual sweep once more. If there is still a fault, consult Pulsar.

## CHAPTER 9 DISPOSAL

Incorrect disposal can cause adverse effects to the environment.

Dispose of the device components and packaging material in accordance with regional environmental regulations including regulations for electrical \ electronic products.

### Transducers

Remove power, disconnect the Transducer, cut off the electrical cable and dispose of cable and Transducer in accordance with regional environmental regulations for electrical \ electronic products.

### Controllers

Remove power, disconnect the Controller, and remove battery (if fitted).

Dispose of Controller in accordance with regional environmental regulations for electrical \ electronic products.

Dispose of batteries in accordance with regional environmental regulations for batteries.



 EU WEEE Directive Logo

This symbol indicates the requirements of Directive 2012/19/EU regarding the treatment and disposal of waste from electric and electronic equipment.

## NOTES



**[www.pulsarmeasurement.com](http://www.pulsarmeasurement.com)**

**SUPPORT@PULSARMEASUREMENT.COM**

*Copyright © 2020 Pulsar Measurement Ltd.*

*Registered Address: 1 Chamberlain Square CS, Birmingham B3 3AX*

*Registered No.: 3345604 England & Wales*

*Rev 1.0*