



SAND ALERT PORTABLE
INSTRUCTION MANUAL

SAND ALERT PORTABLE (FIRST EDITION) REVISION 3

April 2014

Part Number M-200-1905-001P

COPYRIGHT

© Isensys LLP, 2011. All rights reserved. No part of this publication may be reproduced, transmitted, transcribed, stored in a retrieval system, or translated into any language in any form without the written permission of Isensys LLP.

WARRANTY AND LIABILITY

Isensys LLP guarantee for a period of 2 years from the date of delivery that it will either exchange or repair any part of this product returned to Isensys LLP if it is found to be defective in material or workmanship, subject to the defect not being due to unfair wear and tear, misuse, modification or alteration, accident, misapplication or negligence.

DISCLAIMER

Isensys LLP gives nor implies any process guarantee for this product, and shall have no liability in respect of any loss, injury or damage whatsoever arising out of the application or use of any product or circuit described herein.

Every effort has been made to ensure accuracy of this documentation, but Isensys LLP cannot be held liable for any errors.

Isensys LLP operates a policy of constant development and improvement and reserves the right to amend technical details as necessary.

TECHNICAL ENQUIRIES

Please contact Isensys LLP for technical support.

COMMENTS AND SUGGESTIONS

If you have any comments or suggestions about this product, then please contact:

Isensys LLP

Isensys LLP
Enigma Commercial Centre
Sandy's Road
Malvern
Worcestershire
WR14 1JJ
United Kingdom

Tel: + 44 (0) 1684 898099

Fax: + 44 (0) 1684 575985

Web Site: <http://www.isensys.co.uk>

e-mail: info@isensys.co.uk

(general information)

e-mail: info@isensys.co.uk

(product support)

Contents

Chapter 1 Start Here	1
About this Manual	1
About the <i>SandAlert Portable</i>	2
Functional Description	3
Calibration	5
Product Specification	6
Chapter 2 Installation	9
Power Supply Requirements	9
Unpacking	9
Location	10
Sensor Positioning	11
Pulsarguard 2001 & 2011 test stimulation	11
How to fit the sensor to the pipe	12
Using a heat shunt	13
Wiring Details	14
Wiring RS485 'T' Connector	15
Wiring 4-20mA Inline Connector	16
Wiring of the Sensor (PulsarGuard 2001)	17
Preparation for Operation	18
Maintenance	18
Chapter 3 How to Use Your <i>SandAlert Portable</i>	19
Operating the Controls	19
Display	19
Run Mode	20
Program Mode	24
How to Access Program Mode	24
Examples of program mode screens	24
Information screen	25
Hot Keys	26
Menu Keys	27
Numeric Keys	27
Using the Menu System	28
Using the RS232 Serial Interface	30
Parameter Defaults	31
Factory Defaults	31
Chapter 4 Menu System and Parameter Guide	32
Top Level Menu	32
System Menu	33
Data Menu	34
Identity Menu	34
Relays Menu	35
Display Menu	36
Output Menu	37
Calibrate Menu	38
Test Menu	38
Chapter 5 Parameter Listing and Descriptions	40
System Menu Parameters	40
System Information	40
Date & Time	40
Passcode	41

Resets.....	41
Sensor.....	41
Daylight Saving Time.....	42
Data Menu.....	45
Trend.....	45
Watchdog.....	46
Identity Menu.....	46
ID Info.....	46
Relays Menu.....	47
R1 Caution.....	47
R2 Alarm.....	47
R3 Failsafe.....	48
Display Menu.....	48
Display.....	48
Scaling.....	49
Totaliser.....	49
Output Menu.....	50
mA Analog.....	50
RS232 Serial.....	51
RS485 Modbus Setup.....	52
Calibrate Menu.....	53
Injection.....	53
Edit Factor.....	54
Test Parameters.....	54
Hardware.....	54
Chapter 6 Modbus.....	56
Protocol Basics.....	57
Modbus.....	57
Typical Transmission Line Activity.....	58
Message Frame Format.....	58
Device Address.....	58
Parameter Address.....	58
Function Codes.....	59
Request & Response Conventions.....	59
Parameter Resolution and Scaling.....	59
Example 1 Write date to Modbus.....	61
Example 2 Taking mA output reading.....	61
Error Checking.....	62
Message Timings.....	63
Mode of Transmission.....	63
Wait Period.....	63
Latency.....	64
Message Transmission Time.....	64
Modbus Functions.....	65
Function 1: Read Output Status.....	65
Example: Query: reading relay 1 to 3.....	65
Function 3: Read Holding Registers (Static Parameters).....	66
Example: Query: reading parameter P200.....	66
Function 4: Read Input Registers (Common Dynamic Variables).....	67
Example: Query: reading Instantaneous SIR.....	67
Function 5: Force Single Coil.....	68
Example: Query: Force coil 2 to be ON.....	68
Function 6: Write Single Register (Static Parameters).....	69
Example: Query: writing to P103 = 1.....	69
Function 8: Diagnostic Loopback.....	70
Example: Command.....	70

Example: Reply	70
Function 16: Write Multiple Registers (Static Parameters).....	71
Example: Query: writing to P400 = 1, P401=2.....	71
Glossary	72
Parameter Record.....	74

Congratulations on your purchase of a Isensys *SandAlert Portable*. This quality system has been developed over many years and represents the latest in high technology ultrasonic sand impact monitoring.

It has been designed to give you years of trouble free performance, and a few minutes spent reading this operating manual will ensure that your installation is as simple as possible.

About this Manual

It is important that this manual is referred to for correct installation and operation.

There are various parts of the manual that offer additional help or information as shown.

Tips



TIP

At various parts of this manual you may find tips to help you.

Additional Information

Additional Information

At various parts of the manual, you will find sections like this that explain specific things in more detail.

References

— See Also

References to other parts of the manual

About the *SandAlert Portable*



Acoustic Sensor



PulsarGuard 2001

The SandAlert portable is a development of the SandAlert 2000 rack and wall mount fixed systems which have been proven in the field for many years.

The single channel sand monitoring system comprises of two main elements, the acoustic sensor “PulsarGuard 2001” and the SandAlert Portable control unit.

The SandAlert Portable is housed in a durable sealed carry case, which makes it easy to move from site to site.

The sensor is a Pulsar Process Measurement intrinsically safe acoustic sensor. It is housed in a robust cast Type 316 stainless steel enclosure. The PulsarGuard 2001 is intrinsically safe, certified to ATEX and to EEx ia IIC T4 (see explanation below).

Explanation of the IS approval description:

EEx	denotes a hazardous area approval.
ia	denotes the device is intrinsically safe category ‘ia’, and therefore is suitable for all zones (0, 1 and 2).
IIC	denotes the gas group. Group IIC, typical gas hydrogen.
T4	denotes the temperature classification.

The SandAlert portable carry case is rated to IP65 giving protection against dust and low pressure water jets when the lid is closed (IP50 when open). The sensor housing is rated at IP68 giving protection against temporary immersion to a depth of 3 metres.

The sensor is powered from a power supply via a galvanic isolator, which is integral to the SandAlert portable controller.

The sensor should be attached to the outside of the pipe, on or just after a bend, by means of a stainless steel band (see picture above). It is connected to the SandAlert Portable control unit via 4 core cable with an overall braided screen (cable reel and connectors provided).

All these features and more plus the ease of programming, make this instrument the number one choice for sand impact measurement in pipes.

Functional Description

The high frequency structure borne acoustic signal generated by a sand impact on the internal wall of a pipe, travels through the pipe wall and is detected by the acoustic sensor. The acoustic signal is then converted to an electrical signal by the sensor.

The electrical signal or sensor output is processed by the electronics in the *SandAlert Portable* control unit to provide a sand impact rate (SIR) in impacts per second (IPS). (This figure is then used by the calibration algorithm to give sand mass).

To illustrate this the following figures (a,b,c & d) show the types of signals that you would expect under conditions of high and low flow rates, with and without sand impacts:

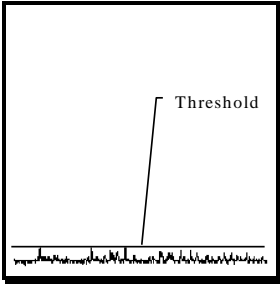

a - Low Flow, No Sand

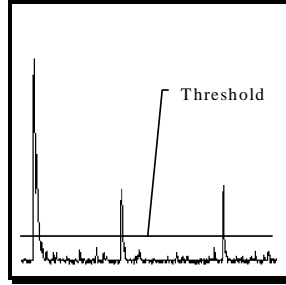

b - Low Flow, With Sand

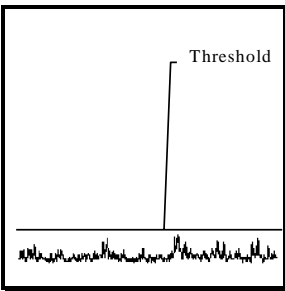

c - High Flow, No Sand

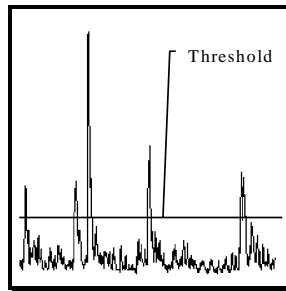

d - High Flow, With Sand

The *SandAlert Portable* monitors the input signal and determines a value for the threshold. The unit eliminates the flow noise by automatically placing a threshold just above the flow related noise signal (average). When the signal cuts the threshold then it is due to sand impacts, which can be seen in figures b and d as short duration, high energy spikes, as compared with the flow related noise that is of lower energy. There is one parameter that influences the threshold and this is P160, this sets the starting level for the threshold.

The 192 x 168 pixel illuminated graphical display shows a general overview of current signal information, a real time sand impact trace graph, a trend graph showing a trend of sand impact rates for up to 91 days and an overview of relay settings. There is also a totaliser that will provide the total weight of sand produced, this requires calibration (see Calibration later in this chapter).

There are 3 relays that can be programmed to activate caution, alarm and failsafe alarms. There is an isolated 4-20mA output that can be connected to a recorder or PLC to monitor the **sand impacts** independently from that shown on the display. Finally, there is an RS232 port, so that the *SandAlert Portable* can be operated remotely by a laptop PC or other equipment to download/upload parameters, view real time echo traces or output regular runtime data in ASCII format.

SandAlert Portable can be programmed either by the built-in keypad, or by PC via the RS 232 Serial Interface. All parameters are stored in non-volatile memory, so are retained in the event of power interruption.

The Isensys *SandAlert Portable* ultrasonic sand monitor has been designed to provide maintenance-free fit and forget performance.

Calibration

The *SandAlert Portable* can be calibrated to give sand produced by one of two methods:

1. Collecting and measuring the mass of produced sand or by injecting a known mass over a known period, this figure is then used to auto-calibrate the unit. The mass/time figure will be based on this calibration.
2. Estimating sand generation and manually editing the calibration factor in mass per ten thousand impacts (TTI).

Method 1 gives the most accurate calibration and is the recommended method.

Product Specification

Physical

Outside dimensions	406 x 330 x 174mm (when closed)
Weight	Nominal 5.1 kg
Enclosure material/description	Pelican 1450 case
Cable entry detail	3 pre-wired multi way IP68 circular connectors, cables supplied with corresponding plugs/sockets.
Transducer cable extensions	4 core with overall screen
Maximum separation	1000 m

Environmental (electronics)

IP Rating	IP65 with lid closed, IP50 with lid open
Max. & min. temperature	-20 °C to +60 °C
Flammable atmosphere approval	Safe area: compatible with approved PulsarGuard transducers

Environmental (PulsarGuard 2001 sensor)

IP Rating	IP68
Max. & min. temperature	-20 °C to +80 °C
Flammable atmosphere approval	Hazardous area: EEx ia IIC T4 Sira 04ATEX2110

Outputs

Analogue output	1 off Isolated (to 150V floating) output of 4-20 mA or 0-20 mA into 1k Ω (user programmable and adjustable) 0.1% resolution
Digital output	Half Duplex RS232
Relays (Volt free contacts)	3 form "C" (SPDT) rated at 5A at 240V AC for caution, alarm and failsafe.
Display	192 x 128 pixel illuminated graphical display Fully programmable display options Integral keypad with menu navigation keys
Communication bus	RS485 Modbus RTU/ASCII (slave device)
On-board programming	By integral keypad
PC programming	via RS232
Programming security	Via passcode (user selectable and adjustable)
Programmed data integrity	Via non-volatile memory

Supply

Power supply

universal 90-264V ac 47-63 Hz via
supplied mains lead
20W maximum power (typically 17W)
3.15A slow blow

Fuse

Toolkit

Outside Dimensions

525 x 436 x 217mm (when closed)

Weight

Nominal 13 Kg

Pulsarguard 2001 sensor

4m cable

Cable Reel

50m

Banding kit

Chain Clamp and heat shunt (optional)

RS232 Lead

2m to 9-way 'D' type socket

RS485 Lead

Includes 'T' junction box for loop in
and out

mA Output Lead

Includes inline connector

Isensys LLP operates a policy of constant development and improvement and reserve the right to amend technical details as necessary.



This page is left blank intentionally.

Power Supply Requirements

SandAlert Portable can operate from ac supply only and is supplied via a universal 90-264Vac transformer. The *SandAlert Portable* will typically consume 17W of power, with a maximum of 20W.

All electronic products are susceptible to electrostatic shock, so follow proper grounding procedures during installation.

Unpacking

All shipping cartons should be opened carefully. When using a box cutter, do not plunge the blade deeply into the box, as it could potentially cut or scratch equipment components. Carefully remove equipment from each carton checking it against the packing list before discarding any packing material. If there is any shortage or obvious shipping damage to the equipment, report it immediately to Pulsar Process Measurement

Location

All electronic products are susceptible to electrostatic shock, so follow proper grounding procedures during installation.

Installation, commissioning and servicing of the system must be strictly in accordance with the applicable standards (incl. hazardous and electrical safety) for the location of the installation. All equipment and system approvals, specifications, warranties and statements of fitness for purpose are conditional upon this requirement being met.

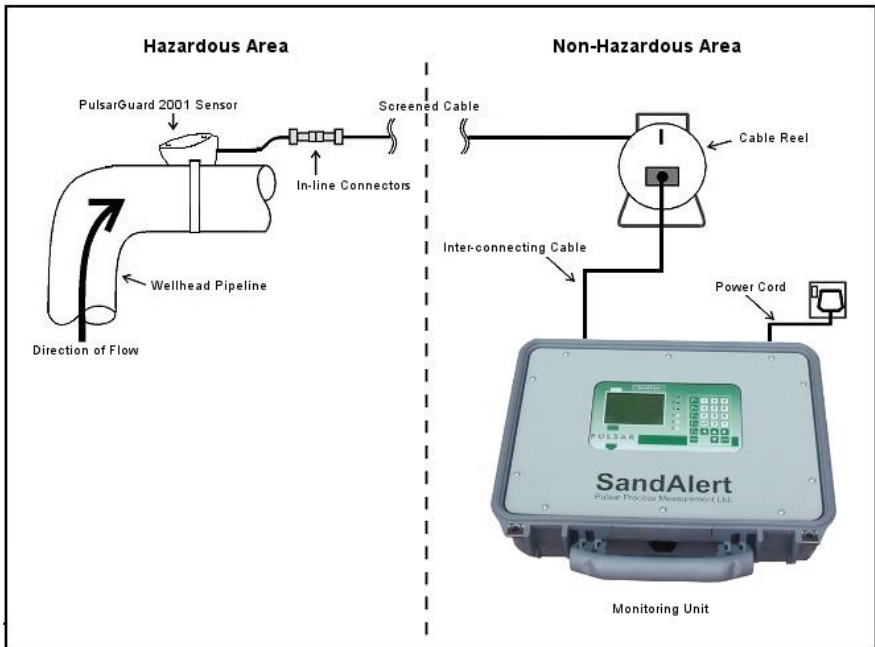

The sensor is certified to ATEX for use in hazardous areas and it is important to ensure that this level of certification is adequate for the area in which the sensor is intended to be installed. **The SandAlert Portable control unit must be situated in a non-hazardous area.**

Sensor Positioning

The acoustic sensor detects the high frequency sound generated by the impacts of sand and other solid particles e.g. proppant on the inside of the pipe wall. **Therefore, the best results will be obtained if the sensor is positioned on or just after a bend** (within two pipe diameters of the bend), or fixed restriction to the flow.

Do not position the sensor in close proximity to a choke, or other variable restriction, since changes in the choke position may affect the SIR readings.

Pulsarguard 2001 & 2011 test stimulation

The way we suggest you test a transducer is either by rubbing the unpainted part with rough sandpaper or lightly dragging a metal object such as a screwdriver over the rough unpainted casting.

Either of these methods should give an output from the transducer, this will show on the display as sand impacts.

Alternatively drop a continuous stream of sand or salt on the face of the transducer.

PulsarGuard 2001 is an acoustic sensor and the coupling between the pipe and the sensor is critical, make sure the pipe is clean and smooth (use sandpaper if necessary to clear the surface of paint or rust).

How to fit the sensor to the pipe

The sensor is fastened to the pipe using the supplied banding. The sensor should be mounted on a straight section of pipe close to a bend on the outside of the bend. The illustration below shows the method of fixing. The banding is passed through the slot in the sensor, the base of the sensor is covered with silicon grease (acoustic couplant) and is then fixed around the pipe (see diagram).

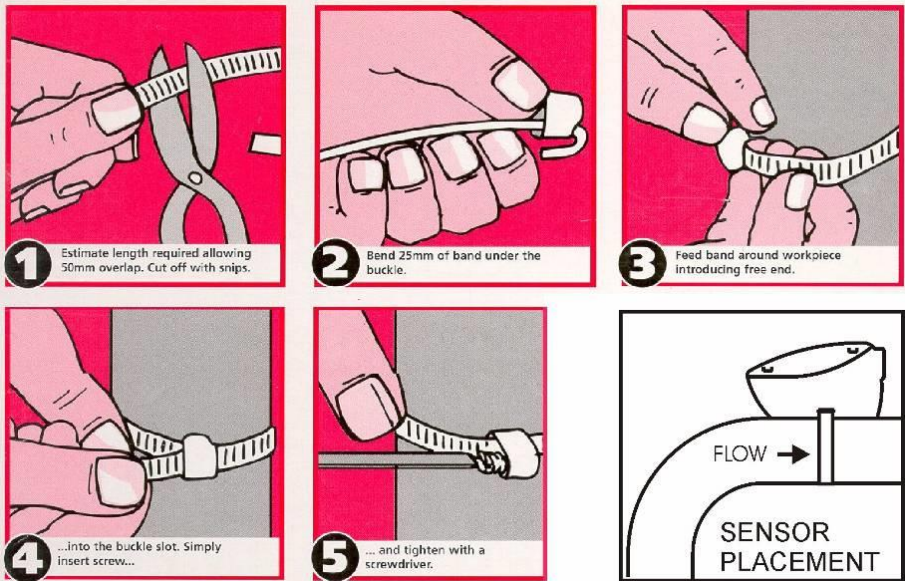

Important Information

The point of contact with the pipe should be cleaned of paint, to ensure that the sensor contacts with bare metal. Some suitable grease, such as silicon grease, must be applied between the pipe and the sensor. This improves the acoustic coupling.

The sensor cannot be damaged by over tightening since the banding is in contact with the metal part of the sensor and not the electronics which are contained within the body of the housing.

Where vibratory conditions exist it is recommended that the free end of the band be restrained or bent so that it will not produce any noise that could be construed as sand impacts.

Using a heat shunt

In high temperature applications where the external temperature of the pipe is greater than the rated temperature of the sensor (typically 75°C), a heat shunt must be used.

The sensor is fastened to the heat shunt as shown below using the same method as fastening to a pipe.

The end of the heat shunt is then fastened to the pipe with the chain clamp using silicon grease as a couplant.

The same measures should be taken when fixing the heat shunt as when fixing directly to the pipe (see “Important Information” on previous page).

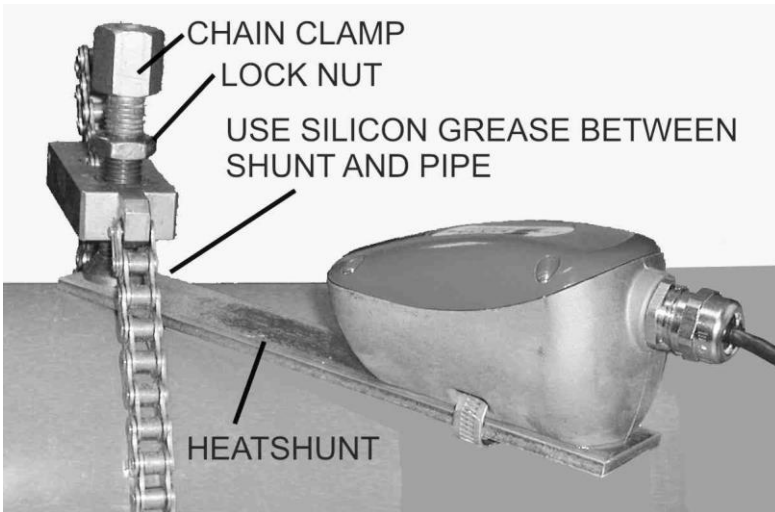

Pulsarguard 2001 sensor fitted to pipe with a heat shunt

Wiring Details

The *SandAlert Portable* is supplied with pre-wired mains, I/O and sensor cables with multi way IP68 connectors.

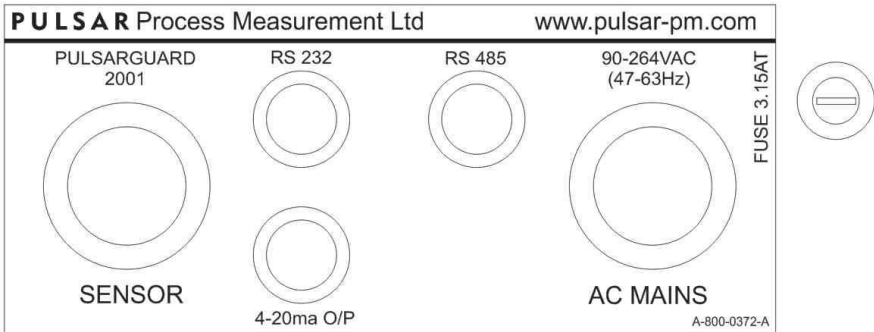

The following table shows details of each connector pin wiring:

Pin	Description
3 way AC Mains Connector	
E	Earth
L	Live
N	Neutral
4 way Sensor Connector	
1	Power (Brown)
2	0V (Green and Yellow)
3	Signal (White)
4	Screen
3 way 4-20mA Connector	
1	mA +
2	mA -
3	Screen

Pin	Description
6 way RS232 connector	
1	Wire link to pin 5
2	TxD
3	RxD
4	NC
5	GND and link to pin 1
6	NC
4 way RS485 Connector	
1	NC
2	RS485 +
3	RS485 -
4	Screen

Important Information

Never operate the *SandAlert Portable* with front panel removed.

Interconnecting cables must be adequately insulated for IEC 664 Category II installations.

Important Information

If the equipment is installed or used in a manner not specified in this manual, then the protection provided by the equipment may be impaired.

Wiring RS485 'T' Connector

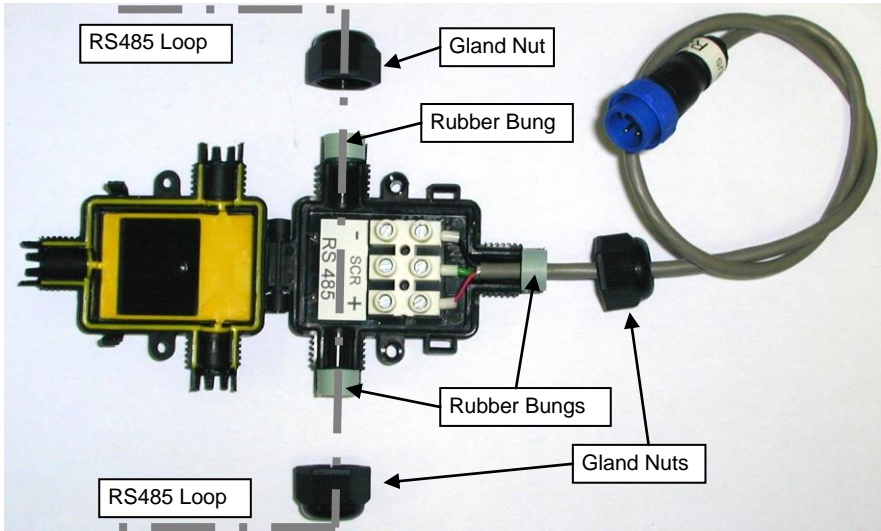

- Fully unscrew all 3 gland nuts and carefully unclip the lid using a flat blade screwdriver (clips indicated by “To Open” text with two arrows on the lid case moulding).
- Wire the RS485 loop through the two unoccupied glands to the -, scr and + terminals. NOTE: To keep the IP rating, the outer insulation of the wire should fit snugly through the rubber bungs (various sizes supplied).
- Close the lid, ensuring that the clips are fully applied, and fully tighten all 3 gland nuts. NOTE: To keep IP rating the gland nuts must be fully tightened with the rubber bungs tightly gripping the outer insulation of the wires.

Wiring 4-20mA Inline Connector

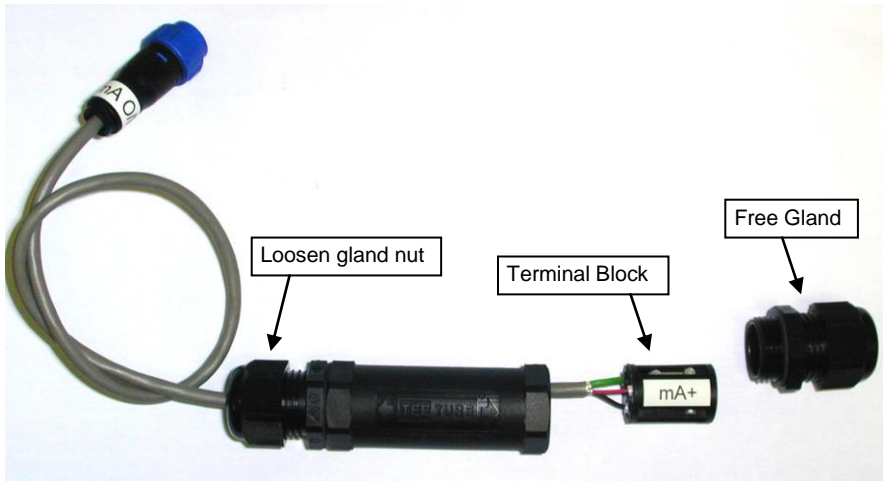

- Completely remove the free gland.
- Loosen the gland nut that contains the existing patch cable such that the cable moves freely in and out.
- Carefully slide the terminal block out of the 'Tee Tube' by pushing the patch cable through.
- Wire the mA +, SCR and mA – into the terminal block ensuring the cable goes through the free gland. NOTE: To keep IP rating, the cable must fit snugly through the rubber bung in the cable gland.
- Push the terminal block back into the 'Tee Tube' housing, screw in the free terminal and tighten both gland nuts to grip the cable. NOTE: To keep IP rating the gland nuts must be fully tightened with the rubber bungs tightly gripping the outer insulation of the wires.

Wiring of the Sensor (PulsarGuard 2001)

Route the cable from the non-hazardous area, in which the *SandAlert Portable* is to be operated, to the sensor position. Avoid running the cable parallel to HV cables to reduce the risk of electrical noise. Be careful not to route the cable in such a way as to obstruct doorways or walkways.

The *SandAlert Portable* control unit must not be operated in a designated hazardous area. It must be located in a designated safe (non-hazardous) area.

The recommended cable is a two pair screened cable, it is possible to use up to 1000 metres of cable between the sensor and the control unit. One end of the cable connects to the *SandAlert Portable* control unit and the other end is wired to the internal terminal block inside the sensor housing.

Refer to the diagram (below) to ensure that all the electrical connections have been made correctly.

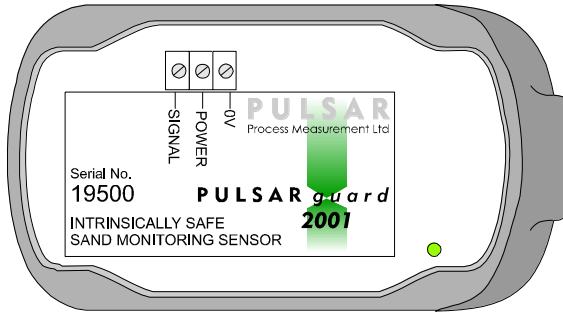

Terminal block inside the sensor

If you use the cable we recommend the colours should be as follows:

Description	Control Unit (cable plug)	Sensor
Power	Brown, pin 1	Brown (power)
0V	Green and Yellow, pin 2	Green and Yellow (0V)
Signal	White, pin 3	White (signal)
Screen	Screen, pin 4	Gland casing

Note that the screen is not connected to terminals at the sensor end (it is connected to the metal gland and casing).

Preparation for Operation

Before switching on, check the following:

- ✓ *SandAlert Portable* is in a 'safe' area.
- ✓ The power supply is correctly installed.
- ✓ The relays are wired correctly.

Maintenance

There are no user serviceable parts inside *SandAlert Portable*, except the mains fuse. If you experience any problems with the unit, then please contact Isensys LLP for advice.

To clean the equipment, wipe with a damp cloth. Do not use any solvents on the enclosure.

Operating the Controls

Display

The graphical display provides four levels of runtime information and a sophisticated, progressive menu system in program mode.

While in **Run Mode**, the ‘**Main**’ screen displays the current sand impact rate SIR reading, the mass in its units of measure, the mA output and the current totaliser value with a graphical representation of impacts per second. To scroll between run mode screens, use the left and right arrow keys (see diagrams below). To switch between points, use the up and down arrow keys.

The ‘**Signal**’ screen shows a live signal snapshot, with various viewing options described later in this chapter.

The ‘**Trend**’ screen gives details of the average sand impacts per second up to the last 91 days (logged per minute).

The ‘**Relays**’ screen gives live information on relay type and current state, a graphical representation of on and off setpoints and the current SIR.

When in **Program mode**, the display is used to read information on the menu system, parameter details and the values/options that can be entered.

There are two main operating modes for your *SandAlert Portable*; **Run Mode** and **Program Mode**. These modes are now described.

Run Mode

This mode is used once the *SandAlert Portable* has been set up in program mode. It is also the default mode that the unit reverts to when it resumes operation after a power failure.

When *SandAlert Portable* is switched on for the first time, it will display the current sand impact rate (SIR) in impacts per second (IPS). All relays by default are switched off.

After programming is complete, any relays that are set will operate when the SIR reaches the relevant setpoint, and the LED's will change colour (unless switched off).

Each screen is now explained in detail:

Main

This screens provides information on current, live readings. Below is an example of what the screen might look like. This is the screen that will be displayed when the *SandAlert Portable* is switched on for the first time.

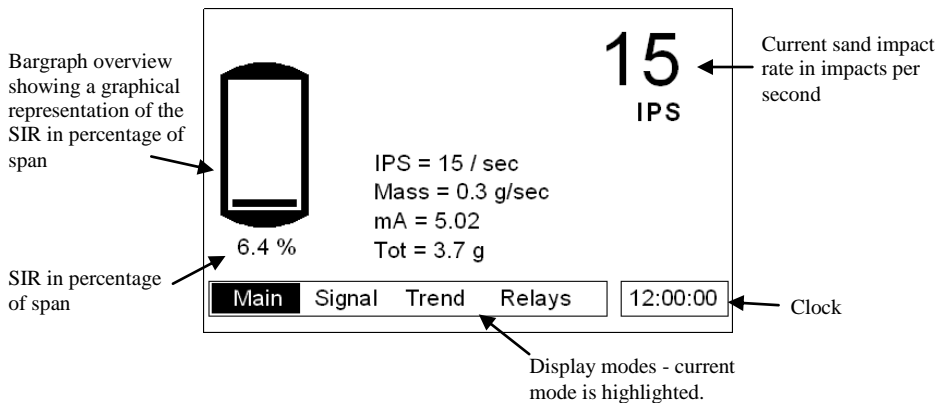

Signal

The signal screen displays a 30ms snapshot of the raw signal data, updated once every cycle. This screen can be used to determine whether a signal is being received from the sensor. Below is an annotated example of a typical response.

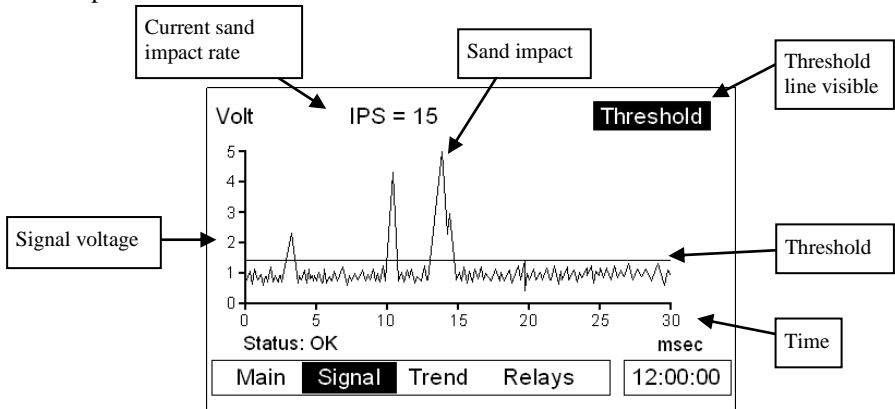

Trend

This screen displays a trend graph showing sand impact rate over a maximum period of 91 days. Every minute, the *SandAlert Portable* can log the instantaneous sand impact rate and display it on the trend graph. At the end of the 91 days, the log will stop and will need to be reset, using P171 Reset Trend, to begin another 91 day log.

There are four zoom levels to the trend graph and the current level is displayed in the top right hand corner. The up and down arrows can be used to move the zoom window (dotted vertical lines) at specific intervals. The enter key will zoom to the next level expanding the data within the zoom window. The cancel key moves back one level.

Trend (1): this is the level the graph will be at when you first enter the trend screen. It is fully zoomed out and shows a trend of 91 days. The zoom window is in intervals of 7 days.

Trend (2): shows a 7 day trend. The zoom window is in intervals of 1 day.

Trend (3): shows a 24 hour trend. The zoom window is in intervals of 2 hours.

Trend (4): shows a 120 minute trend. There is no zoom window at this level.

Example screenshot of the trend graph screen at level 2 (7 days):

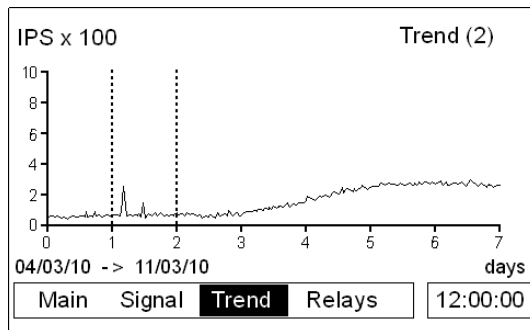

Relays

The relays screen indicates the current state of all relay outputs and gives a visual representation of the current sand impact rate and the on setpoints of the individual relays. The SIR icon “→” represents the current SIR. The failsafe relay does not relate to SIR and so will be displayed without the graphical representation of SIR or setpoints but will still show the relay type and status.

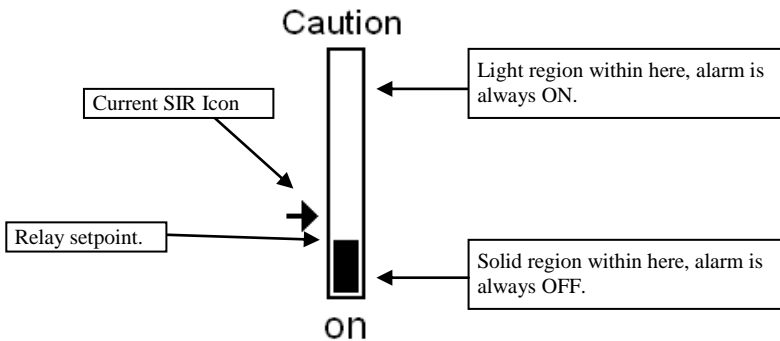
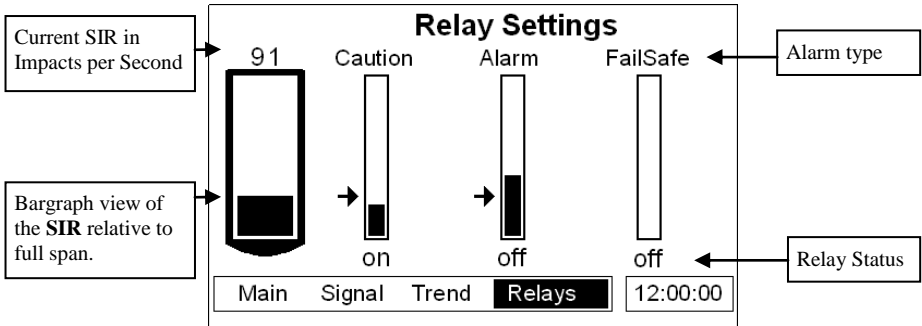

SIR Icon	Description
→	Current sand impact rate, shown on left hand side of relay diagram.

Program Mode

This mode is used to set up the *SandAlert Portable* or change information already set. You must use the built-in keypad to access program mode. Alternatively the unit can be set up with a PC via the RS 232 Serial Interface.

Entering a value for each of the parameters that are relevant to your application provides all of the programming information.

How to Access Program Mode

With *SandAlert Portable*, to enter **program mode**, you simply enter the passcode, via the keypad, followed by the **ENTER** key. The **default passcode** is **1997**, so you would press the following:

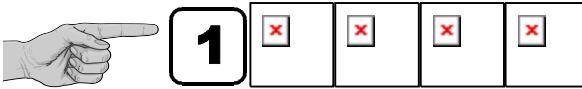

Note

There is a time-out period of 15 minutes when in **program mode**, after which time **run mode** will be resumed. The timer is reset every time a key is pressed.

Examples of program mode screens

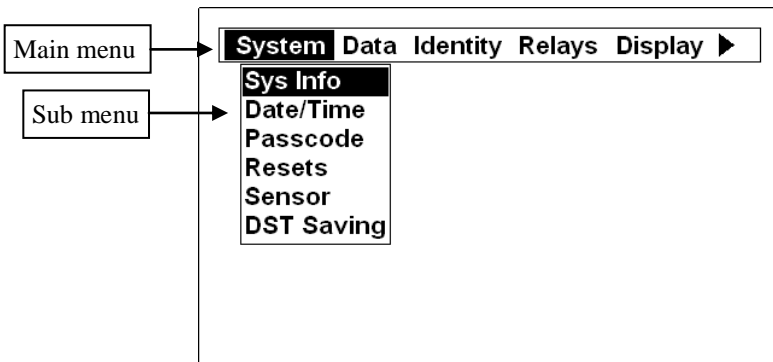

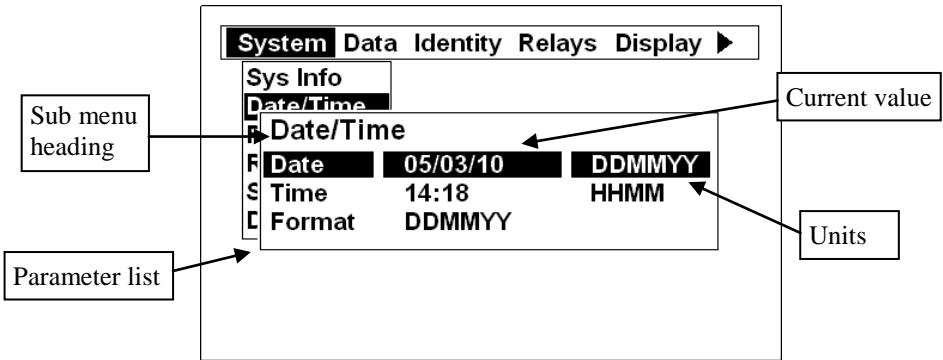

Information screen

The information screen can be used to view system details such as Software revision, serial number etc. but can also be used to view a summary of the application settings. To access the information screen, press the  button when the *SandAlert Portable* is in *run mode*. There are 3 pages within the information screen, preceded by the pulsar logo, showing the current page number at the bottom centre of the information screen. The screens will automatically scroll but can also use the up and down arrow keys to toggle between pages an example of page 1 is shown below:

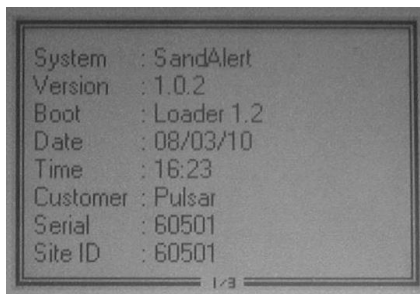







Page 1: General information about the system, see example above.

Page 2: Information about communications set up incl. RS232 and RS485 (if available).

Page 3: Information about mA output set up incl. mode, setpoints etc.



Hot Keys

There are five hot keys on the keypad that can be used to quickly access certain functions while in Run Mode. Pressing the hot key once will initiate or toggle the function assigned to that key, then the *SandAlert Portable* reverts to the Run Mode display, if applicable. In program mode, they have different functions. Information displayed by the function keys in the “Main” screen will timeout and disappear after 20s. The functions are shown below:

Hot Key	Run Mode	Program Mode
	Toggle the Threshold line in the “Signal” screen.	Clear the current value.
	Not used with <i>SandAlert Portable</i> .	Not used with <i>SandAlert Portable</i> .
	Not used with <i>SandAlert Portable</i> .	Reset parameter to default setting.
	Not used with <i>SandAlert Portable</i> .	Not used with <i>SandAlert Portable</i> .
	Not used with <i>SandAlert Portable</i> .	Not used with <i>SandAlert Portable</i> .
	Not used with <i>SandAlert Portable</i> .	Toggle negative values.
	Displays the information screen, timeout 20 seconds.	Enter decimal point.

Menu Keys

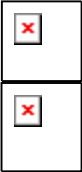
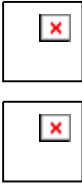
The menu keys have the following functions:

Menu Key	Function
	1) Arrow keys for moving left and right through the menu system and used as 'backspace' when editing the value of a parameter. 2) Used for changing display mode in run mode.
	1) Arrow keys for moving up and down through the menu system 2) Used for changing y axis scale in the Signal screen in runmode. 3) Used to move the zoom window in the Trend screen in runmode.
	1) Used to confirm each action (for example, select a menu option or accept a parameter number or value). 2) Used to confirm questions asked by your <i>SandAlert Portable</i> such as before restoring factory defaults.
	1) Used to navigate up a level in the menu system, and back to run mode. 2) Used to cancel a value entered in error.

Numeric Keys

These keys are used for entering numerical information during programming or to enter the passcode from run mode.

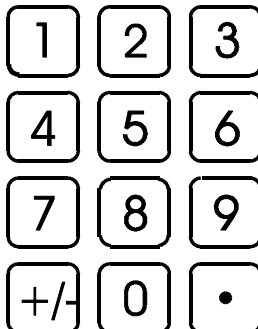

There are two means of editing parameters, directly or using the menu system. Each is now described.

Using the Menu System

The menu system has been designed to make the changing of parameters very simple. There are two levels of menu: **Main Menu** and **Sub Menu**.

At the top of the display there is a line of text that displays the main menu items. Pressing the left/right arrow keys scrolls the display between the top-level menu items, (as the example shown below, starting at System).

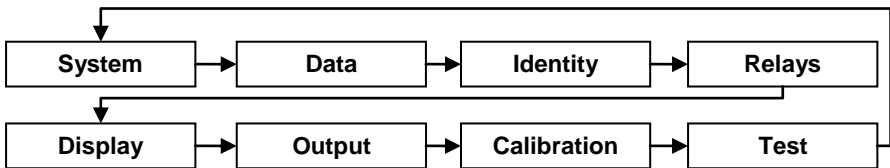

As you press the cursor keys to scroll left and right between these, you can press **ENTER**, or the down arrow, at any time, to expand the sub-menu.

Each menu option, along with their sub-menus, is described later in this manual. When you move down into the sub-menu, you can scroll up and down using the arrow keys and then press **ENTER** to go to the required parameter lists. If there are more menu options or parameters than can be viewed on the display in one go, then a scroll bar will appear on the right hand side of the menu/parameter box. The position of the solid bar within the scroll bar provides a visual aid as to your position in the current menu.

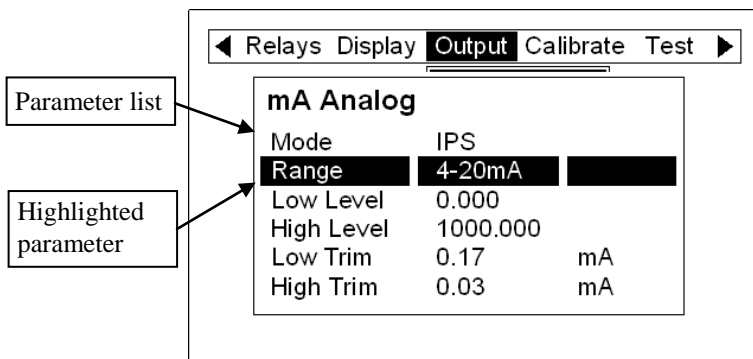

Once you have reached the relevant section, scroll down the parameter list to highlight the parameter you wish to edit and press **ENTER** to access the parameter options. When you are at parameter level, the options for that parameter will be displayed on the screen. If the parameter has preset options then scroll up or down, with the up/down arrow keys, or press the designated number key (displayed on the left hand side) to highlight the option, then press **ENTER** to save. If the parameter requires you to enter a value within a particular range, the range options will be displayed with a box to enter the value. Use the numeric keypad to enter the required value following the onscreen prompts and press **ENTER** to save.

When you have finished, press **CANCEL** to go back to the previous menu level. When you have reached the top level, press the **CANCEL** button again, the *SandAlert Portable* will ask for confirmation before allowing you return to run mode. This is done by pressing **ENTER** at the display prompt.

Directly Editing Parameters

If you already know the number of the parameter that you wish to look at or edit, simply type the number in while you are in the main menu system. Thus, if there is nothing on the screen apart from the top menu, by pressing a numeric key, you can enter the parameter number directly and jump straight there. You cannot type a parameter number whilst at parameter level or when a sub menu is visible, use cancel to return back to the top menu.

When you are at parameter level, the options for that parameter will be displayed on the screen. If the parameter has preset options then scroll up or down, with the up/down arrow keys, until the required option is highlighted, then press **ENTER** to change it. If the parameter requires a value within a particular range, the range options will be displayed with a box to enter the value. Use the numeric keypad to enter the required value following the onscreen prompts and press **ENTER** to save it.

Once you have accessed a parameter, you can either just look at it, or change it.

Once a parameter has been changed, press **ENTER** and you will see the parameter value changed in the parameter list. If you press **CANCEL** then you will be returned to the parameter list with no change to the values.

Using the RS232 Serial Interface

The RS232 serial interface is used to communicate between the *SandAlert Portable* and a PC using the SandAlert PC software and other associated Pulsar software packages. It can be used to obtain information such as data logging and view echo traces, upload, download and save parameter files. In addition it can also be used to control or obtain information using a standard PC or other computer base equipment. To do so, the default settings for communications port are as follows: **baud rate 19,200, 8 data bits, no parity, 1 stop bit.**

The RS232 serial interface can also be used to output regular data, in ASCII format, to be monitored or logged with third party software. To do this, the **Serial Enable** parameter, **P510**, must be set to **1 = Yes** (default), the **Data Format** set in **P511** and a suitable time **interval** set in **P512** (default 60s).

The device should be connected as shown in **Chapter 2 Installation**.

To use the device remotely, you need to **log on** to start, and **log off** when finished. When **logged on**, *SandAlert Portable* will show “**Remote**” on the display in place of the clock. When logged off, the display will return to normal (clock will be displayed).

All commands should be followed by a carriage return.

The unit will respond either OK or a value if the command is accepted, or NO if the command is not recognised or is not available.

To log on, send the command

/ACCESS:1997 where 1997 is the passcode (P121).

To log off, send the command

/ACCESS:OFF

To read a parameter value, send the command

/Pxxx where xxx is the parameter you wish to read, and the *SandAlert Portable* will respond with the parameter value.

To set a parameter, send the command

/Pxxx:yy where xxx is the parameter number, and yy is the value you wish to set it to.

Parameter Defaults

Factory Defaults

Factory Defaults

When first installing the *SandAlert Portable*, or subsequently moving or using the unit on a new application, before proceeding to program the unit for its intended application it is recommended that you ensure that all parameters are at their default values by completing a **Factory Defaults P930**, as described in the **parameter guide**.

When you first switch on the *SandAlert Portable*, it will be reading from the sensor. The display will be indicating in **SIR** and relays 1 and 2 (caution and alarm) are set to their default values.

The **date** (P110) and **time** (P111) in *SandAlert Portable* were set at the factory, but may need checking and amending if, for example the application is in a time zone other than GMT, see relevant **Parameter listing** for full details.

Once you are satisfied with the installation, and *SandAlert Portable* is reading what you would expect in terms of sand impact rate, then you can proceed with programming for the intended application. It is sensible to program all of the required parameters at the same time. The system will then be fully set-up.

Chapter 4 Menu System and Parameter Guide

This section outlines all parameters available in the *SandAlert Portable*, as they appear in the menu system.

Shown below is a set of charts to show you how all the various parts can be found using the menu system.

For further details and a full description of all parameters refer to Chapter 5 Parameter Listings and Descriptions.

Top Level Menu

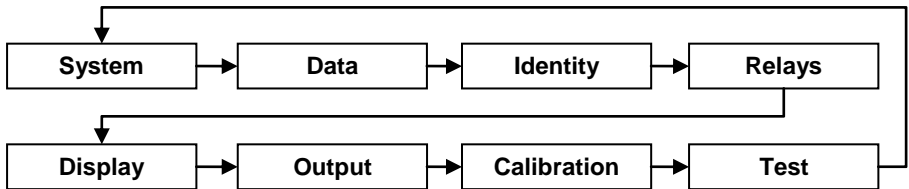

System Menu

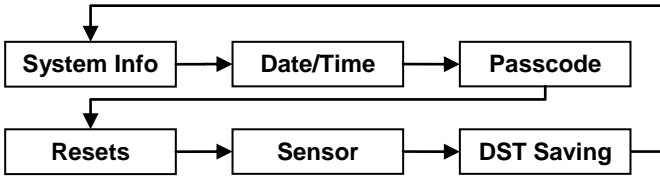

System Info

- P100 Software Rev.
- P101 Hardware Rev.
- P102 Serial Number
- P103 Site Ident.

Date/Time

- P110 Date
- P111 Time
- P112 Date Format

Passcode

- P120 Passcode Enable
- P121 Passcode

Resets

- P930 Factory Default

Sensor

- P160 Threshold

DST Saving

- P970 DST Enable
- P971 Difference
- P972 Start Time
- P973 Start Day
- P974 Start Week
- P975 Start Month
- P976 End Time
- P977 End Day
- P978 End Week
- P979 End Month

Data Menu

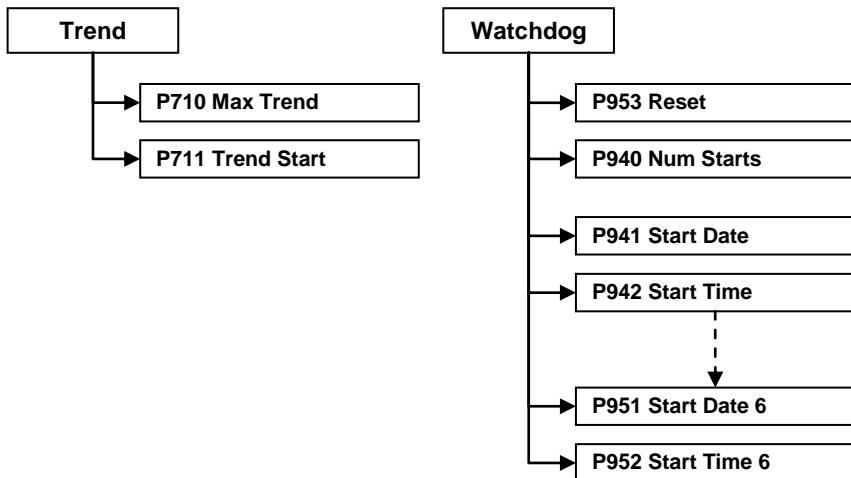
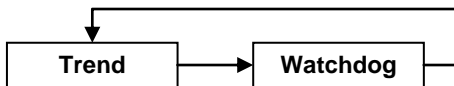

Identity Menu

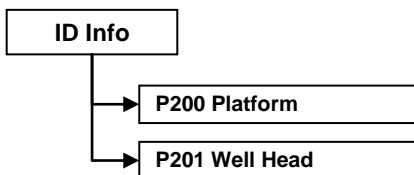
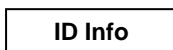

Relays Menu

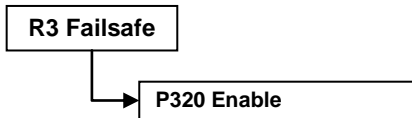
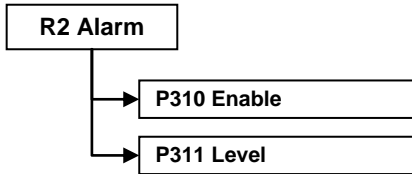
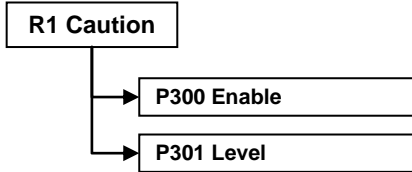
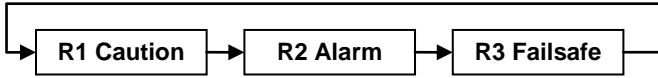

Display Menu

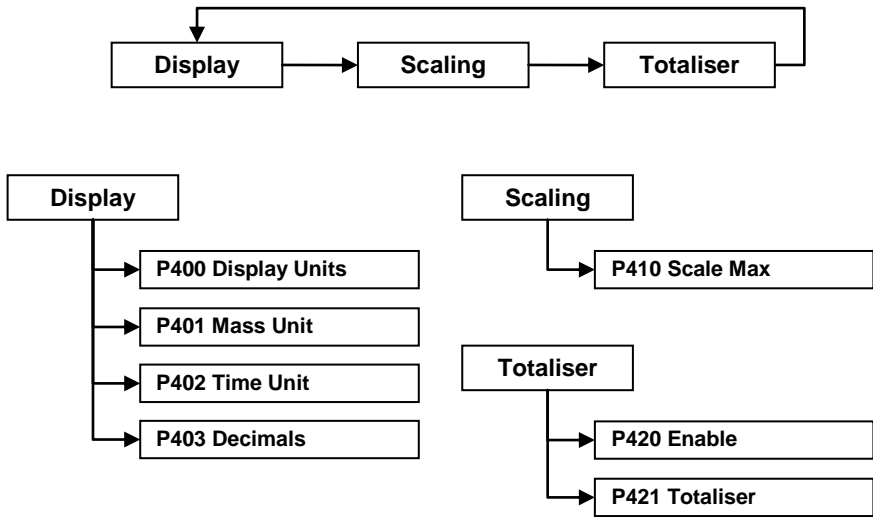

Output Menu

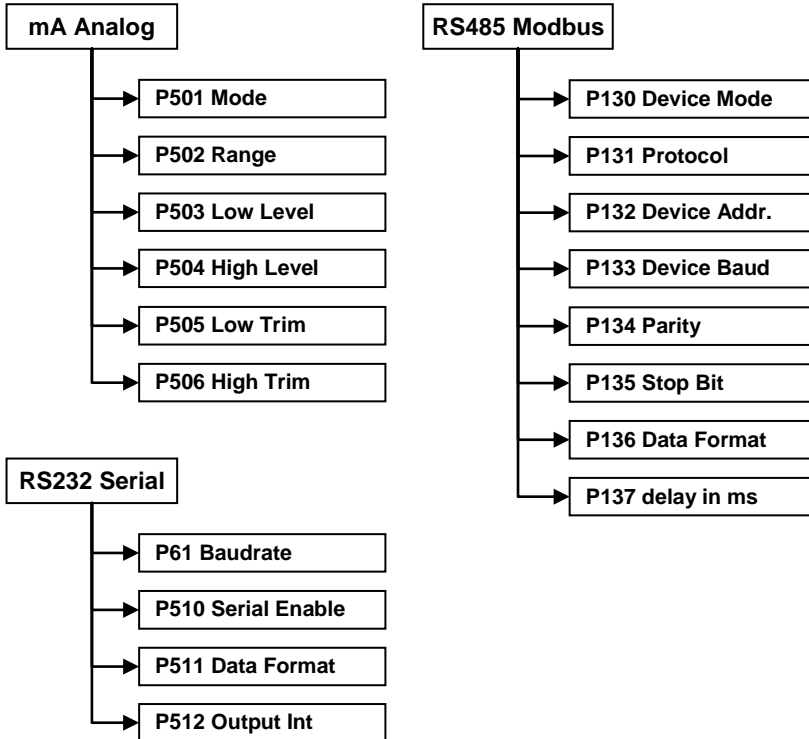
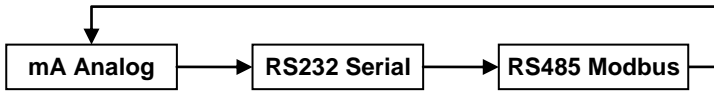

Calibrate Menu

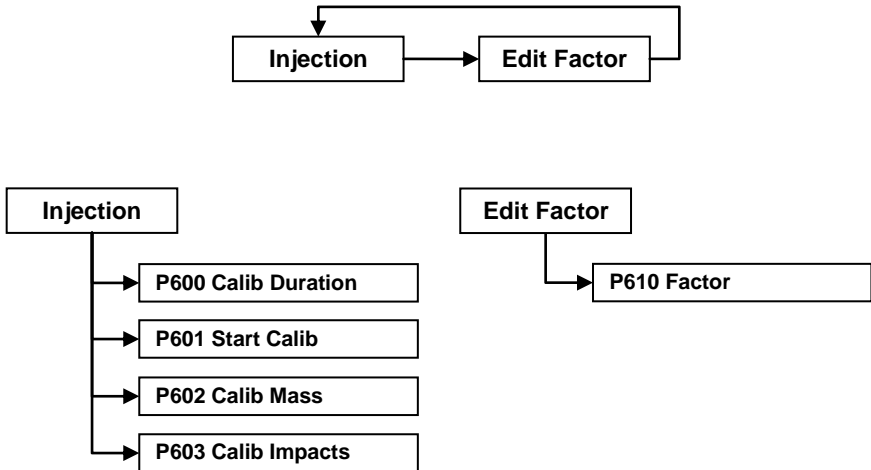

Test Menu

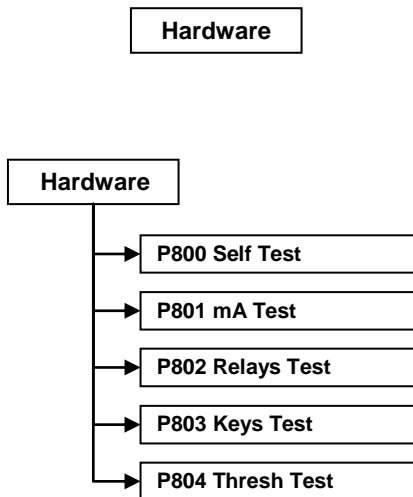

System Menu Parameters

System Information

The following three parameters do not affect how the unit performs, but details, contained in them, may be required, by Pulsar, when making technical enquiries.

P100 Software Revision

This parameter will display the current software revision. It is read only, and cannot be changed.

P101 Hardware Revision

This parameter will display the current hardware revision. It is read only, and cannot be changed.

P102 Serial Number

This parameter will display the serial number of the unit. It is read only, and cannot be changed.

P103 Site Identification

This parameter allows you to give each unit an individual reference number, for identification purposes. You can set any number between 1 and 99999.

Date & Time

The date and time is used to date stamp certain events that are contained in the Data and Trend Logs. It is also used in conjunction with the system watchdog that keeps an eye on the times the unit has started.

P110 Date

This parameter displays the **current date**, in the format as set by **P112 (Date Format)**, and can be reset if required.

P111 Time

This parameter displays the **current time** and can be reset if required, in the format HH: MM (24-hour format). This is set initially at the factory for UK time.

P112 Date Format

This parameter allows you to alter the format that the date is displayed to your choice of DD: MM: YY, MM: DD: YY or YY: MM: DD. The default is DD: MM: YY.

Passcode

P120 Enable Code

Enables the passcode (**P121**), which means the passcode must be entered to go into program mode. If **disabled** (set to **0**), then no passcode is required, and **ENTER** is used to enter program mode. **Default =1 (Enabled)**

P121 Passcode

This is the passcode that must be used to enter program mode. The **default** is **1997**, but this can be changed to another value from 0 to 9999.

Resets

P930 Factory Defaults

This parameter resets all parameter values to the original Factory Set values that were installed when the unit was tested, before despatched to you.

To **reset** parameters, enter **1 (Yes)**, and press **ENTER**, then you will see a message “**Enter if sure**”, you should press **ENTER** again. If you press any other key at this point, the parameters will not be reset, and you will see a message confirming this.

Once you have done this, program the unit, to the desired application.

Sensor

P160 Threshold

This parameter sets the value in mV above the average signal strength that the threshold sits. This will effectively change the sensitivity of the sensor.

Minimum = 0 mV, Maximum 5000 mV

Default = 500 mV

Daylight Saving Time

Important Information

In order to ensure the correct operation of Daylight Saving Time **P111 Time** should be checked, and adjusted if necessary, to ensure that it is set for the current valid time.

P970 DST Enable

When **Enabled** (set to **1**) the internal clock will be automatically adjusted to compensate for the difference between standard time and **Daylight Saving Time**. **Default = 1 (Yes)**

P971 Difference

This parameter sets the time difference between standard time and **Daylight Saving Time**. The time difference is entered in HH:MM. **Default = 01:00**

P972 Start Time

This parameter is used to set the **time** of day at which **Daylight Saving Time** will **start**, the time is entered in the format HH: MM (24-hour format). **Default = 02:00**

P973 Start Day

Use this parameter to enter the **day** of the week (**P974**) that **Daylight Saving Time** is to **start**.

Option	Description
2= Monday	DST will start on a Monday
3= Tuesday	DST will start on a Tuesday
4= Wednesday	DST will start on a Wednesday
5= Thursday	DST will start on a Thursday
6= Friday	DST will start on a Friday
7= Saturday	DST will start on a Saturday
8= Sunday (Default)	DST will start on a Sunday

P974 Start Week

This parameter will determine the **week** of the month (**P975**) in which **Daylight Saving Time** is to **start**.

Option	Description
1= Week 1	DST will start on day (P973) in the first week (P974) of the month (P975).
2= Week 2	DST will start on day (P973) in the second week (P974) of the month (P975).
3= Week 3	DST will start on day (P973) in the third week (P974) of the month (P975).
4= Week 4	DST will start on day (P973) in the fourth week (P974) of the month (P975).
5= Last (Default)	DST will start on day (P973) in the last week (P974) of the month (P975).

P975 Start Month

This parameter is used to select the **month**, in which **Daylight Saving Time** will **start**.

Option	Description
1= January	DST will start during the month of January
2= February	DST will start during the month of February
3=March (Default)	DST will start during the month of March
4= April	DST will start during the month of April
5= May	DST will start during the month of May
6= June	DST will start during the month of June
7= July	DST will start during the month of July
8= August	DST will start during the month of August
9= September	DST will start during the month of September
10= October	DST will start during the month of October
11= November	DST will start during the month of November
12= December	DST will start during the month of December

P976 End Time

This parameter is used to set the **time** of day at which **Daylight Saving Time** will **end**, the time is entered in the format HH: MM (24-hour format).
Default = 02:00.

P977 End Day

Use this parameter to enter the **day** of the week (**P974**) that **Daylight Saving Time** is to **end**.

Option	Description
2= Monday	DST will end on a Monday
3= Tuesday	DST will end on a Tuesday
4= Wednesday	DST will end on a Wednesday
5= Thursday	DST will end on a Thursday
6= Friday	DST will end on a Friday
7= Saturday	DST will end on a Saturday
8= Sunday (Default)	DST will end on a Sunday

P978 End Week

This parameter will determine the **week** of the month (**P975**) in which **Daylight Saving Time** is to **end**.

Option	Description
1= Week 1	DST will end on day (P977) in the first week (P978) of the month (P979).
2= Week 2	DST will end on day (P977) in the second week (P978) of the month (P979).
3= Week 3	DST will end on day (P977) in the third week (P978) of the month (P979).
4= Week 4	DST will end on day (P977) in the fourth week (P978) of the month (P979).
5= Last (Default)	DST will end on day (P977) in the last week (P978) of the month (P979).

P979 End Month

This parameter is used to select the **month**, in which **Daylight Saving Time** will **end**.

Option	Description
1= January	DST will end during the month of January
2= February	DST will end during the month of February
3= March	DST will end during the month of March
4= April	DST will end during the month of April
5= May	DST will end during the month of May
6= June	DST will end during the month of June
7= July	DST will end during the month of July
8= August	DST will end during the month of August
9= September	DST will end during the month of September
10= October (Default)	DST will end during the month of October
11= November	DST will end during the month of November
12= December	DST will end during the month of December

Data Menu

This menu contains parameters that allow control over the Trend graph (shown on the 'Trend' screen at runmode) and allows viewing and resetting of the system watchdog.

Trend

The *SandAlert Portable* provides a facility to log and display a trend of sand average impacts per second for up to 91 days at 1 minute intervals.

P710 Max Trend

This parameter allows the user to scale the trend graph in run mode by setting the maximum value of the y axis in impacts per second (IPS).

Minimum = 0, Maximum = 65535

Default = 1000 IPS

P711 Trend Start

This parameter enables/restarts or disables the trend logging with the following options:

Option	Description
0 = No (Default)	Disable the trend log.
1 = Restart	Restarts and enables trend logging.

Watchdog

You can check how many times the unit has been switched on, and look at the date and time of the last seven starts. This can be useful if there have been power failures or if for any reason the *SandAlert Portable* restarts due to a fault condition.

P940 Number of Starts

This parameter shows how many times the unit has been powered up.

P941-P952 Start Date & Time

Parameters **P941** and **P942** show the **date** and **time** that the unit was last started. There are **seven start dates & times** recorded, which are parameters **P943-P952**. The first on the list are the most recent, and the last ones are the oldest. These are read only, and cannot be changed.

P953 Reset

This parameter resets the watchdog.

Identity Menu

This menu allows a number from 0 - 9999 to be chosen for the identification of the platform and wellhead, this information can be included in the serial data transmission for identification purposes.

ID Info

P200 Platform

Numeric identification for the platform between 0 and 9999.

P201 Well Head

Numeric identification for the well head between 0 and 9999.

Relays Menu

The *SandAlert Portable* has three relays; Relay 1, Caution, Relay 2, Alarm and Relay 3, FailSafe. The following parameters describe how to set up each relay.

Alarm relays are **Energised** in their **normal state** (no alarm) so alarms are **activated** by **de-energising** the relay. This ensures that an alarm is raised in the event of power failure of the *SandAlert Portable* unit. During normal operation (no alarm) the corresponding LED on the front panel will be illuminated green and in alarm condition will be red.

R1 Caution

P300 - Enable

This parameter enables or disables the caution relay. **Default = Yes**

P301 Level

This parameter changes the level at which the alarm activates (when exceeded) and deactivates (when the sand rate drops). Values are entered in the current **display units (P400-P402)**.

Minumim = 0, Maximum = 9999

Default = 100 IPS.

R2 Alarm

P310 - Enable

This parameter enables or disables the alarm relay. **Default = Yes**

P311 Level

This parameter changes the level at which the alarm activates (when exceeded) and deactivates (when the sand rate drops). Values are entered in the current **display units (P400-P402)**.

Minumim = 0, Maximum = 9999

Default = 100 IPS.

R3 Failsafe

The failsafe relay activates if a sensor is not detected or there is a fault with the signal. It can also be used for indication of power failure. When the unit is functioning normally and the failsafe relay is enabled, the relay is energised and the LED is yellow. On power failure or sensor failure, the relay will de-energise.

P320 - Enable

This parameter enables or disables the failsafe relay. **Default = No**

Display Menu

Display

P400 Display Units

This parameter determines whether the reading displayed is in **Impacts per second** or **Mass/Time Units (P401 & P402)**.

Option	Description
1 = Mass/Time	Display is in selected units dependant on Mass unit (P401) and Time unit (P402).
2 = IPS (Default)	Display is in Impacts per Second .

P401 Mass Unit

This parameter determines the mass units with the following options:

Option	Description
1 = Gram (Default)	Units are in grams.
2 = Kilogram	Units are in kilograms.
3 = Ounce	Units are in ounces.
4 = Pound	Units are in pounds.

P402 Time Unit

This parameter determines the time units with the following options:

Option	Description
1 = Second (Default)	Units are in seconds.
2 = Minute	Units are in minutes.
3 = Hour	Units are in hours.
4 = Day	Units are in days.

P403 Decimals

This parameter determines the number of decimal places on the reading during run mode.

Minimum = 0 (No decimal places), Maximum 3 = (3 decimal Places)

Default = 1 (1 decimal place)

Scaling

P410 Scale Max

Sets the maximum value for the bar graph (100%) on the display in runmode.

Minimum = 10, Maximum = 10,000

Default = 2000.

Totaliser

P420 Enable

This parameter determines whether the totaliser is enabled or not. The options are as follows:

Option	Description
0 = No	Totaliser will be disabled.
1 = Yes (Default)	Totaliser will be enabled.

P421 Totaliser

Displays the current value of the system totaliser (also displayed in the 'Main' screen in runmode). This value can be reset by entering zero.

Output Menu

mA Analog

P501 Mode

This parameter determines how the mA Output relates to what is measured. By **default** it operates on the sand impact rate per second (IPS), but it can be set to operate as follows:

Option	Description
1 = Mass/Time	mA output relative to Mass/Time .
2 = IPS (Default)	mA output relative to IPS .

P502 Range

This parameter determines the range of the mA output, from the following.

Option	Description
1= 0 to 20 mA	mA output directly proportional to the mA mode (P501) , so if the reading is 0% the output is 0 mA. If the reading is 100% the output is 20 mA.
2= 4 to 20 mA (Default)	mA output directly proportional to the mA mode (P501) , so if the reading is 0% the output is 4 mA. If the reading is 100% the output is 20 mA.
3= 20 to 0 mA	mA output inversely proportional to the mA mode (P501) , so if the reading is 0% the output is 20 mA. If the reading is 100% the output is 0 mA.
4= 20 to 4 mA	mA output inversely proportional to the mA mode (P501) , so if the reading is 0% the output is 20 mA. If the reading is 100% the output is 4 mA.

P503 Low Level

This parameter sets the level at which the low mA output will occur (**0** or **4mA** dependant on **(P502) mA Range**)

Default = 0 IPS

P504 High Level

This parameter sets the level at which the high mA output will occur (**20mA**).

Default = 300 IPS

P505 Low Trim

If the device you are connected to is not calibrated, and not showing the correct **low value**, then you can trim it using this parameter. You can either type in the offset directly, or use the up/down arrow keys to move the output up and down until you get the expected result on the device that is connected.

P506 mA High Trim

If the device you are connected to is not calibrated, and not showing the correct **high value**, then you can trim it using this parameter. You can either type in the offset directly, or use the up/down arrow keys to move the output up and down until you get the expected result on the device that is connected.

RS232 Serial

P061 Baudrate

This parameter is used to set the speed (Baud Rate) of the RS232 communications and can be changed to suit the connecting device.
Default = 19200

P510 Serial Enable

This parameter switches on or off regular data transmission through the RS232 serial port in accordance with **P511 Data Format** and **P512 Output Interval**. Options are:

Option	Description
0 = No	Serial output will be disabled .
1 = Yes (Default)	Serial output will be enabled .

P511 Data Format

This parameter determines the format of the data output through the serial port if **P510 Serial Enable** is enabled (date and time is always included in output). The options are as follows:

Option	Description
1 = Rate	Output the av. mass/time rate and mass per interval.
2 = Totaliser	Output the system totaliser.
3 = Rate/Total	Output the av. mass/time rate, mass per interval and system totaliser.
4 = All (default)	Output all data including Platform ID, Well Head ID, Date/Time, SIR, av. mass/time rate, mass per interval and system totaliser.

P512 Output Interval

This parameter determines the time between serial transmissions.

Minimum = 5 s, Maximum = 99999 s

Default = 60 s

RS485 Modbus Setup

The following parameters will require programming before the RS 485 communications can be used.

Par. No.	Options	Description
P 130	0 – Off 1 – Slave	Select mode, Off or Slave, choose 1 for slave
P 131	0 – Modbus RTU 1 – Modbus ASCII	Protocol , select either 0 or 1 for Modbus RTU or ASCII over RS485
P 132	1 to 255	Device Address – Enter the device number for this unit
P 133	1200, 2400, 4800, 9600, 19200, 38400, 115200	Baud Rate – Enter your system baud rate
P 134	0 – No Parity 1 – Odd Parity 2 – Even Parity	Parity – set your system parity
P 135	1 – One stop bit 2 – Two stop bits	Stop Bits – set to your system stop bit setting.
P 136	0 – Unsigned Integer 1 – Signed Integer	Data Format – Set your preference, Unsigned 0 to 65335 Signed –32768 to +32768
P 137	0 to 9999	Delay in mS

Note : Only Slave operation with Modbus RTU and Modbus ASCII are available

Calibrate Menu

The *SandAlert Portable* can be calibrated to give sand produced by one of two methods:

1. Collecting and measuring the mass of produced sand or by injecting a known mass over a known period, this figure is then used to auto-calibrate the unit. The mass/time figure will be based on this calibration.
2. Estimating sand generation and manually editing the calibration factor in mass per ten thousand impacts (TTI).

Method 1 gives the most accurate calibration and is the recommended method.

Injection

This menu provides parameters and options to calibrate using method 1 (above). To use this mode you can either inject a known amount of sand or collect produced sand for a known time and weigh it. All you do is set the duration of the test and when you are ready to start set parameter P601 to 1 and press enter. After the duration has finished, enter the weight of sand, the unit will then calibrate itself. The value used for the conversion of Impacts per Second to weight is stored in P610 this is the calibration factor and can be edited manually if required. It may be a good idea after calibration to note down the factor the unit calculated. The number of impacts recorded during the calibration can be viewed in P603 Calib Impacts.

P600 Calib Duration

This parameter sets the duration of the calibration procedure in minutes.

Minimum = 0, Maximum 100

Default = 2 mins

P601 Start Calibration

This parameter starts the calibration procedure. The options are as follows:

Option	Description
0 = No	Cancel out of the parameter and do nothing.
1 = Yes (Default)	Start the calibration.

P602 Calib Mass

After calibration, the mass of injected sand should be entered here in the mass units.

Minimum = 0, Maximum = 99999

Default 100 grams

P603 Calib Impacts

After calibration, the number of impacts recorded during calibration will be displayed here.

Note: If the **Calib Mass (P602)** or the **Calib Impacts (P603)** parameters are manually changed at any time, the calibration **Factor (P610)** will be recalculated automatically.

Edit Factor

P610 Factor

This parameter allows viewing and editing of the calibration factor. It represents the mass of ten thousand sand impacts (TTI).

Minimum = 0, Maximum = 99999

Default = 10 grams/TTI

Test Parameters

Hardware

P800 Self Test

If you enter 1 for this parameter, then the unit will perform a self-test. This will confirm that the various parts of the circuitry are working correctly. You will see confirmation messages that the clock and the EEPROM are working correctly, and error messages for any parts that fail.

P801 mA Test

This parameter will allow you to force a specified current on the mA output to test the equipment that it is connected to and to make sure the unit is working correctly. The figure you enter will be generated by the mA output after pressing the enter key to accept.

P802 Relays Test

Press a numeric key corresponding to the number of the relay you wish to test, and the relay will change state each time the key is pressed. If you press any other key other than a valid relay number then the test will end.

P803 Keys Test

You should press each key, to confirm it works, with a counter showing how many more keys you have to press. Press the **CANCEL** key last, as this will confirm if all keys were pressed or not. If they were not, then an error message is displayed.

P804 Threshold Test

This is a service parameter used for testing the threshold voltage by Pulsar engineers.

Chapter 6 Modbus

The following parameters will be found in the *SandAlert Portable* under the Output – RS 484 Modbus menu and will require programming before the RS 485 communications can be used.

Par. No.	Options	Description
P 130	0 – Off 1 – Slave	Select mode, Master or Slave, choose 0 for slave
P 131	0 – Modbus RTU 1 – Modbus ASCII	Protocol , select either 0 or 1 for Modbus RTU or ASCII over RS485
P 132	1 to 255	Device Address – Enter the device number for this unit
P 133	1200, 2400, 4800, 9600, 19200, 38400, 115200	Baud Rate – Enter your system baud rate
P 134	0 – No Parity 1 – Odd Parity 2 – Even Parity	Parity – set your system parity
P 135	1 – One stop bit 2 – Two stop bits	Stop Bits – set to your system stop bit setting.
P 136	0 – Unsigned Integer 1 – Signed Integer	Data Format – Set your preference, Unsigned 0 to 65535 Signed –32768 to +32768
P 137	0 to 9999	Delay in mS

Note : Only Slave operation with Modbus RTU and Modbus ASCII are available

Protocol Basics

A data communication protocol defines the rules and structure of messages used by all devices on a network for data exchange. This protocol also defines the orderly exchange of messages, and the detection of errors.

Modbus

MODBUS defines a digital communication network to have only one MASTER and one or more SLAVE devices. Either a single or multi-drop network is possible. The two types of communications networks are illustrated in the diagram below

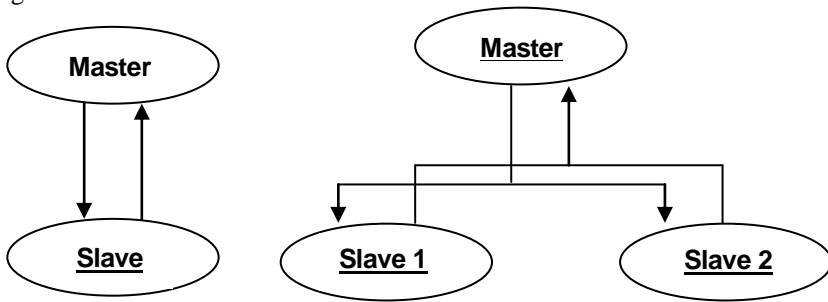

A typical transaction will consist of a request sent from the master followed by a response from the slave. The message in either direction will consist of the following information

Start of Transmission	Device Address	Function Code	Data or List of Data	CRC Error Check	End of Transmission
-----------------------	----------------	---------------	----------------------	-----------------	---------------------

- Each slave has a unique *Device Address*
- The device address 0 is a special case and is used for message broadcast to all slaves. This is restricted to parameter write operations
- The SandAlert controller supports a subset of Modbus standard function codes. There are 8 Modbus functions used: 1, 2, 3, 4, 5, 6, 8 and 16
- The data will include instrument parameters referenced by a *Register Address*
- Sending a communication with a unique device address will cause only the device with that address to respond. That device will check for errors, perform the requested task and the reply with its own address, data and a checksum
- Sending a communication with the device address 0 is a broadcast communication that will send information to all devices on the network. Each will perform the required action but will not transmit a reply

Typical Transmission Line Activity

This diagram is to illustrate typical sequence of events on a Modbus transmission line

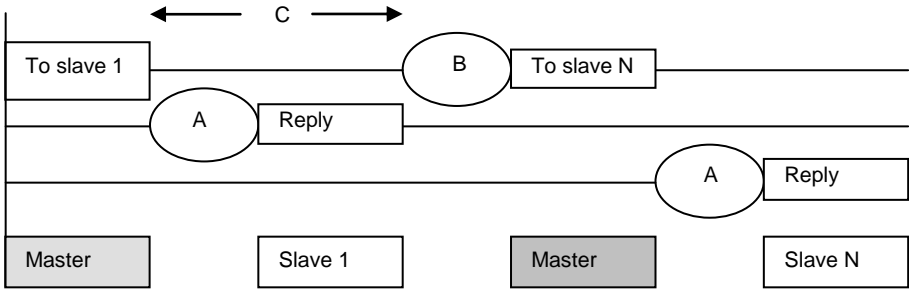

- Period 'A': the processing time (latency) required by the slave to complete the command and construct a reply
- Period 'B': the processing time required by the master to analyse the slave response and formulate the next message
- Period 'C': the wait time calculated by the master for the slaves to perform the operation. None of the slaves will reply to a broadcast message

Message Frame Format

Device Address

Each slave has a unique address. The Modicon Modbus protocol defines the address range limits as 1 to 247. The SandAlert will support an address range of 1 to 254. The device address used by the instrument is set using the Set up Parameters List according to the instrument manuals.

Device address 0 is a special case that will broadcast a message to all slaves simultaneously.

Parameter Address

Data bits or data words exchange information between master and slave devices. This data consists of parameters. All parameters communicated between master and slaves have a 16-bit parameter address, which is referred to as *Register Address*.

The Modbus Register Address range is 100 to 999 according to parameter list of P100-P999 on the SandAlert instrument. If an invalid parameter is requested, accessing these parameters will result in an error code 02 (data unavailable – refer to Error Checking Section for more details).

Function Codes

Standard Modicon Modbus provides function codes from 1 to 247. Pulsar Modbus protocols support function 1, 2, 3, 4, 6, 8 and 16.

Function Code	Function Descriptions	Data Type
01	read coil status	bit mapped
02	read input status	bit mapped
03	read holding register	integer
04	read input register	integer
05	Force single coil	
06	write single register	integer
08	diagnostic loop back	none
16	write multiple registers	integer

It is recommended that function code 03 or function code 04 is used for reads and function code 06 is used for writes. This includes Boolean data. Other codes are supplied for purposes of compatibility.

The instruments will transmit error codes if they receive a request including an unsupported function code.

Request & Response Conventions

Parameter Resolution and Scaling

Standard Modbus protocol limits data to 16 bits per parameter. This reduces the active range of parameters from 0 to 65535 (decimal) as unsigned integer and from -32767 to +32767 as signed integer.

The protocol is also limited to integer communication only. The blackbox 134 (LCD) provides data in either signed or unsigned integer type (word). In Integer Format, all parameters will be rounded to the specified units. Example of this protocol is shown in Section 5. The following table shows the unit symbols and their corresponding conversions

Unit Symbol	Scaling	Descriptions
U_NO	None	no unit scaling
U_MS	× 0.1 Mass/s	mass units per second
U_MT	× 0.1 Mass/Time	mass units per time units
U_TIME	HHMM	hh:mm
U_DATE	coded date	see Example (1)
U_DDMM	DDMM	day and month dd/MM
U_YEAR	YYYY	year
U_MA	× 0.1 mA	mA input/output
U_MV	× .001 V	milli-Volts
U_RELAY	Bit pattern	0 de-energised, 1 energised, BIT 0 = relay 1, BIT 1 = relay 2 and BIT2 = relay 3

Example 1 Write date to Modbus

To write to Modbus a date of 02/03/01 – the coded date is calculated as follows

Note

This date presentation comprises of coded date in the form yxxx, where xxx is calculated as follows to give the date and month.

$$xxx = (\text{month} * 50) + \text{day} = (03 * 50) + 02 = 152$$

$$yxxx = (\text{year} * 1000) + xxx = (01 * 1000) + 152 = 1152 \text{ (decimal)}$$

To decode back to normal format of ddmmyy,

$$yy = 1152 \text{ mod } 1000 = 1$$

$$mm = (1152 \text{ rem } 1000) \text{ mod } 50 = 3$$

$$dd = 1152 - yy * 1000 - mm * 50 = 2$$

Therefore,

$$\text{ddmmyy} = dd * 10000 + mm * 100 + yy = 20301 \text{ (decimal)}$$

which has string equivalent of 02/03/01

Example 2 Taking mA output reading

Taking a mA output reading from Modbus register = 156

Actual mA value is = $256 * \text{Scaling} = 256 * 0.1 = 15.6 \text{ mA}$

Error Checking

The Modbus protocol defines the response to a number of error conditions. A slave device is able to detect a corrupted command or, one that contains an incorrect instruction, and will respond with an error code.

With some errors the slave devices on the network are unable to make a response. After a wait period the master will interpret the failure to reply as a communication error. The master should then re-transmit the command.

A slave device that has detected a corrupted command or a command that contains an incorrect instruction will respond with an error message. The error message has the following syntax.

Device Address	Function Code	Error Response Code	CRC checksum	
1 byte	1 byte	1 byte	MSB	LSB

The function code byte contains the transmitted function code but with the most significant bit set to 1.

(This is the result of adding 128 to the function code)

The error response code indicates the type of error detected. The SandAlert supports the following error response codes:

Error Code	Error	Description
0x01	Illegal function	The message function received is not an allowable action
0x02	Illegal address	The address referenced in the data field is not an allowable address for the slave
0x03	Illegal data value	The value referenced in the data field is not allowable in the addressed slave location
0x04	Failure in associated device	The slave has failed to respond to a message or an abortive error occurred
0x05	Acknowledge	The slave has accepted and is processing the long duration program command
0x06	Busy, rejected message	The message was received without error, but the slave is processing a long duration program command
0x07	NAK Negative Acknowledgement	The PROGRAM function just requested could not be performed
0x08	Invalid checksum	Checksum is incorrect or corrupted
0x09	Invalid data count	The number of data count is outside the specified data range

Message Timings

Mode of Transmission

The mode of transmission describes the structure of information within a message and the number coding system used to exchange a single character of data.

The Modbus protocols define a mode of transmission for both ASCII and RTU modes of transmission. The SandAlert support both transmission modes. Details of how to set up these modes are provided earlier in the manual.

The definition of the mode of transmission for a single character is

Start bit (1 bit)	Data bits (7 or 8 bits)	Parity bit (odd, even or none)	Stop bits (1 or 2 bits)
----------------------	----------------------------	-----------------------------------	----------------------------

Transmission baud rate can be set ranges from 1200 – 38400 baud.
Factory default setting is 19200 baud.

Wait Period

There are several errors for which the slave devices on the network are unable to make a response:

- If the master attempts to use an invalid address then no slave device will receive the message
- For a message corrupted by interference, the transmitted CRC will not be the same as the internally calculated CRC. The slave device will reject the command and will not reply to the master

After a wait period, the master will re-transmit the command.

A wait period is also required after a broadcast communication to device address 0.

The wait period should exceed the instrument latency plus the message transmission time. Typical wait periods, for a single parameter read are at most 100 ms for the SandAlert.

Caution

Failure to observe the wait period, after a broadcast, will negate the broadcast message.

Latency

The time taken for the SandAlert to process a message and start the transmission of a reply is called the latency. This does not include the time taken to transmit the request or reply.

The parameter functions read 1 word (function code 03), write 1 word (function code 06) and Loopback (function code 08) are processed within the latency of between 20 and 100 ms.

For parameter functions, read N bits (function 01), read N words (function 03 or function 04) and write N words (function 16) the latency is indeterminate. The latency will depend on the instrument activity and the number of parameters being transferred and will take from 100 to 500 ms approximately.

It is possible to artificially increase the latency by setting the *Delay* parameter in the Set Up configuration list. This is sometimes required to allow a guaranteed gap between requests and responses needed by some RS485 adapters to switch from transmit to receive states.

Message Transmission Time

The time required to transmit a message will depend on the length of the message and the baud rate.

$$\text{Transmission Time} = \frac{(\text{NumberOfBytes} * 3.5) * \text{BitsPerCharacter}}{\text{BaudRate}}$$

To find the number of bytes, refer to the relevant function code. The three extra bytes are for the end of transmission characters

The number of bits per character will be ten, or eleven if a parity bit is used. (For Modbus RTU: 1 start bit, 8 data bit, an optional parity bit and 1 stop bit)

For example reading a single word with the function code 03 at 19200 baud (no parity bit)

$$\text{transmission} = \frac{(8 * 3.5) * 10}{19200} = 6ms \qquad \text{response} = \frac{(9 * 3.5) * 10}{19200} = 6.5ms$$

The wait period for this transmission will exceed 22.5 ms (6 + 6.5 + 10.0)

For a broadcast command (device address 0) the master would not expect a reply. In this case the wait period will exceed 16 ms (6 + 10.0)

Modbus Functions

Function 1: Read Output Status

Registers Address	Description	Data Type	Unit/Range
00001 – 00006	Relay status	Bit mapped	None

Note

1. Bit value of **1** represents an **ACTIVE STATE** of the corresponding relay.
2. Bit value of **0** represents an **IN-ACTIVE STATE** of the corresponding relay.

Example: Query: reading relay 1 to 3

Slave address	11
Function	01
Addr Hi	00
Addr Lo	02
No. of points hi	00
No. of points lo	03
Error check	

Response: relay 1 = on, relay 2 = off, relay 3 = on

Slave address	11
Function	01
Byte count	01
Data (coil 2-4)	05
Error check	

Function 3: Read Holding Registers (Static Parameters)

Registers Address	Description	Unit/Range
40100 – 40999 ⁽¹⁾	Set up Parameters	See Appendix

Note

1. All parameters from P100-P999 in the parameter list, (refer to parameter descriptions), are available on Modbus for reading.
2. If the read input register returns a value which is equal to 55555 in decimal then the required parameter is not valid for the unit type.

Example: Query: reading parameter P200

Slave address	11
Function	03
Addr Hi	00
Addr Lo	C7
No. of points hi	00
No. of points lo	01
Error check	

Response: P200=1503 (transmit as 1503 = 05DF)

Slave address	11
Function	03
Byte count	02
Data Hi (MSB)	05
Data Lo (LSB)	DF
Error check	

Function 4: Read Input Registers (Common Dynamic Variables)

This function provides accesses to common system variables of the ultrasonic level instruments. Further data addresses can be added to the list upon user request.

Register	Description	Unit
Measurement 1		
30001	Instantaneous SIR	U_NO
30002	Average SIR/second	U_NO
30010	Peak SIR	U_NO
mA Output		
30021	mA Output	U_MA
Statuses		
30030	Relay Status	U_RELAY
Totaliser		
30050	System Totaliser (top)	U_NO
30051	System Totaliser (bottom)	U_NO
Measurement 2		
30062	Average signal voltage	U_MV
30063	Threshold voltage	U_MV
30070	Average Mass/second	U_MS
30071	Average Mass/time units	U_MT
Date & Time		
30080	Current Time	U_TIME
30081	Current Date (coded)	U_DATE
30082	Current days and month	U_DDMM
30083	Current year	U_YEAR

Example: Query: reading Instantaneous SIR

```

Slave address      11
Function           04
Addr Hi           00
Addr Lo           00
No. of points hi  00
No. of points lo  01
Error check
Response: SIR=62 IPS (transmit as 62= 003E)
Slave address      11
Function           04
Byte count        02
Data Hi (MSB)     00
Data Lo (LSB)     3E
Error check
    
```

Function 5: Force Single Coil

This function provides a means of forcing a single coil to either ON or OFF. When broadcast the function forces the same coil references in all attached slaves.

Note

This function will override the SandAlert's memory protect state and the coil's disable state. The force state will remain valid until such time it is forced OFF by the MODBUS.

The query message will specify the coil reference that is to be forced, coils are addressed starting at zero, therefore coil 1 is addressed as 0.

The requested ON/OFF state is specified by a constant in the query data field, a value of **FF00** (Hex) will request the coil to be forced **ON**, where as a value of **0000** (Hex) will request the coil to be forced **OFF**. All other values are not recognised and will have no affect on the coil status. Once the coil status has been forced, then the SandAlert will take control of either switching it OFF or ON.

Device Address	Function Code	Coil Address		Forced Data		CRC	
		MSB	LSB	MSB	LSB	MSB	LSB
1 byte	1 byte						

Example: Query: Force coil 2 to be ON

Slave address	11
Function	05
Addr Hi	00
Addr Lo	01
Data Hi	FF
Data Lo	00
Error check	
Response:	
Slave address	11
Function	05
Addr Hi	00
Addr Lo	01
Data Hi	FF
Data Lo	00
Error check	

Function 6: Write Single Register (Static Parameters)

Registers Address	Description	Unit/Range
40100 – 40999 ⁽¹⁾	Setup parameters ⁽²⁾	⁽³⁾

Note

1. Only parameters from P100 to P999 are available for writing from remote communication. Parameters less than P100 have to be accessed directly on the unit keypad or infra-red communicator
2. Refer to the previous chapter for list of accessible parameters.

Example: Query: writing to P103 = 1

Slave address	11
Function	06
Addr Hi	00
Addr Lo	66
Data Hi	00
Data Lo	01
Error check	
Response:	
Slave address	11
Function	06
Addr Hi	00
Addr Lo	66
Data Hi	00
Data Lo	01
Error check	

Function 8: Diagnostic Loopback

This function provides a means of testing the communications link by means of a 'Loopback' operation. The data sent to the instrument is returned unchanged. Only diagnostic code 0 from Modicon Specification is supported.

Device address	Function Code	Diagnostic Code		Loopback Data		CRC	
1 byte	1 byte	MSB	LSB	MSB	LSB	MSB	LSB

The reply to function 08 is the same as the command

Example: Command

Device address	Function Code	Diagnostic Code		Loopback Data		CRC	
02	08	00	00	12	34	ED	4F

Example: Reply

Device address	Function Code	Diagnostic Code		Loopback Data		CRC	
02	08	00	00	12	34	ED	4F

Function 16: Write Multiple Registers (Static Parameters)

Registers Address	Description	Unit/Range
40100 – 40999 ⁽¹⁾	Set up parameters ⁽²⁾	⁽³⁾

Note

1. Only parameters from P100 to P999 are available for writing from remote communication. Parameters less than P100 have to be accessed directly on the unit keypad or infra-red communicator
2. Refer to the previous chapter for list of accessible parameters.

Example: Query: writing to P400 = 1, P401=2

Slave address	11
Function	10
Addr Hi	01
Addr Lo	90
No. of registers hi	00
No. of registers lo	02
Data Hi	00
Data Lo	01
Data Hi	00
Data Lo	02
Error check	

Response:

Slave address	11
Function	06
Addr Hi	01
Addr Lo	90
No. of registers hi	00
No. of registers lo	02
Error check	

Glossary

ASCII	American Standard Code for Information Interchange (or conforming to).
Baud rate	Signal events per second in digital communications (often approximated as bits/second)
DST	Daylight Saving Time
IPS	Impacts Per Second
Latency	Time between receiving a transmission and sending a response.
SIR	Sand Impact Rate
RS232	Serial communications between the instrument and a PC communications port.
RS485	2-wire (in our case) field bus communication method.
RTU	Remote Transmitter/Termination Unit – a device that connects to a local communications loop.
TTI	Ten Thousand Impacts

This page is left blank intentionally

Parameter Record

Operation

Parameter Details		Entered Values					
No.	Description	Default	1	2	3	4	5
P100	Software Rev.	n/a					
P101	Hardware Rev.	n/a					
P102	Serial Number	n/a					
P103	Site ID	(serial num)					

Date/Time

Parameter Details		Entered Values					
No.	Description	Default	1	2	3	4	5
P110	Date	Current Date					
P111	Time	Current Time					
P112	Date Format	1=DDMMYY					

RS485 Modbus

Parameter Details		Entered Values					
No.	Description	Default	1	2	3	4	5
P130	Device Mode	0 = Off					
P131	Protocol	0 = RTU					
P132	Device Addr	1					
P133	Device Baud	19200					
P134	Parity	2 = Even					
P135	Stop Bit	1					
P136	Data Format	0 = Unsigned					
P137	Tx Delay	5					

Passcode

Parameter Details		Entered Values					
No.	Description	Default	1	2	3	4	5
P120	Passcode Enable	1 = Enable					
P121	Passcode	1997					

Sensor

Parameter Details		Entered Values					
No.	Description	Default	1	2	3	4	5
P160	Threshold	500 mV					

ID Info

Parameter Details		Entered Values					
No.	Description	Default	1	2	3	4	5
P200	Platform	1					
P201	Well Head	1					

Relay 1 Caution

Parameter Details		Entered Values					
No.	Description	Default	1	2	3	4	5
P300	Enable	1 = Yes					
P301	Level	100 IPS					

Relay 2 Alarm

Parameter Details		Entered Values					
No.	Description	Default	1	2	3	4	5
P310	Enable	1 = Yes					
P311	Level	200 IPS					

Relay 3 Failsafe

Parameter Details		Entered Values					
No.	Description	Default	1	2	3	4	5
P320	Enable	0 = No					

Display

Parameter Details		Entered Values					
No.	Description	Default	1	2	3	4	5
P400	Display Units	2 = SIR					
P401	Mass Unit	1 = Gram					
P402	Time Unit	1 = Second					
P403	Decimals	1 = 1dp					

Scaling

Parameter Details		Entered Values					
No.	Description	Default	1	2	3	4	5
P410	Scale Max	2000					

Totaliser

Parameter Details		Entered Values					
No.	Description	Default	1	2	3	4	5
P420	Enable	1 = Yes					
P421	Totaliser	n/a					

mA Analog

Parameter Details		Entered Values					
No.	Description	Default	1	2	3	4	5
P501	Mode	2 = IPS					
P502	Range	2 = 4-20					
P503	Low Level	0					
P504	High Level	300					
P505	Low Trim	0 mA					
P506	High Trim	0 mA					

RS232 Serial

Parameter Details		Entered Values					
No.	Description	Default	1	2	3	4	5
P61	Baudrate	19200					
P510	Serial Enable	1 = Yes					
P511	Data Format	4 = All					
P512	Output Interval	60 sec					

Injection

Parameter Details		Entered Values					
No.	Description	Default	1	2	3	4	5
P600	Calib duration	2 min					
P601	Start Calib	0 = No					
P602	Calib Mass	100 Grams					
P603	Calib Impacts	0					

Edit Factor

Parameter Details		Entered Values					
No.	Description	Default	1	2	3	4	5
P610	Factor	10 g/TTI					

Trend

Parameter Details		Entered Values					
No.	Description	Default	1	2	3	4	5
P710	Max Trend	1000					
P711	Trend Start	0 = No					

Daylight Save

Parameter Details		Entered Values					
No.	Description	Default	1	2	3	4	5
P970	DST Enable	0					
P971	DST Difference	01:00					
P972	DST Start Time	02:00					
P973	Start Day	8					
P974	Start Week	1					
P975	Start Month	3					
P976	DST End Time	02:00					
P977	End Day	8					
P978	End Week	5					
P979	End Month	10					