



# Quantum<sup>2</sup>

**Instruction Manual**





**FLOWCERT LITE (FOURTH EDITION REV 1)**

February 2021

Part Number M-142-Q-004-1P

***COPYRIGHT***

© Pulsar Measurement, 2012 -21. All rights reserved. No part of this publication may be reproduced, transmitted, transcribed, stored in a retrieval system, or translated into any language in any form without the written permission of Pulsar Process Measurement Limited.

***WARRANTY AND LIABILITY***

Pulsar Measurement guarantee for a period of 2 years from the date of delivery that it will either exchange or repair any part of this product returned to Pulsar Process Measurement Limited if it is found to be defective in material or workmanship, subject to the defect not being due to unfair wear and tear, misuse, modification or alteration, accident, misapplication, or negligence.

***DISCLAIMER***

Pulsar Measurement neither gives nor implies any process guarantee for this product and shall have no liability in respect of any loss, injury or damage whatsoever arising out of the application or use of any product or circuit described herein.

Every effort has been made to ensure accuracy of this documentation, but Pulsar Measurement cannot be held liable for any errors.

Pulsar Measurement operates a policy of constant development and improvement and reserves the right to amend technical details, as necessary.

The Quantum<sup>2</sup> shown on the cover of this manual is used for illustrative purposes only and may not be representative of the actual Quantum<sup>2</sup> supplied.

***CONTACT***

For technical support, please contact:

Europe: [supporteurope@pulsarmeasurement.com](mailto:supporteurope@pulsarmeasurement.com)

Outside Europe: [supportnorthamerica@pulsarmeasurement.com](mailto:supportnorthamerica@pulsarmeasurement.com)

If you have any comments or suggestions about this product, please contact:

Europe: [europa@pulsarmeasurement.com](mailto:europa@pulsarmeasurement.com)

Outside Europe: [northamerica@pulsarmeasurement.com](mailto:northamerica@pulsarmeasurement.com)

Pulsar Measurement website: [www.pulsarmeasurement.com](http://www.pulsarmeasurement.com)

**United States**

11451 Belcher Road South  
Largo,  
FL 33773  
888-473-9546

**Canada**

16456 Sixsmith Drive  
Long Sault, Ont.  
K0C 1P0  
855-300-9151

**United Kingdom**

Cardinal Building, Enigma  
Commercial Centre  
Sandy's Road, Malvern  
WR14 1JJ  
00 44 (0)1684 891371

## CONTENTS

Contents .....	4
Chapter 1: Start Here.....	10
About this Manual .....	10
About the Quantum <sup>2</sup> .....	11
Functional Description .....	11
Product Specification.....	13
EU Certificate of Conformity.....	15
Chapter 2 Quantum <sup>2</sup> Installation.....	16
Unpacking .....	16
Power Supply Requirements.....	16
Location .....	17
Dimensions .....	18
Fascia Mount.....	18
Terminal connection details.....	20
Power .....	21
Transducer(s).....	21
ATEX .....	21
Digital Inputs.....	24
Voltage selector and fuse location.....	24
Preparation for Operation .....	26
Maintenance .....	26
Chapter 3 How To Use Your Quantum <sup>2</sup> .....	27
Operating the Controls.....	27
Run Mode.....	28
Program Mode.....	29
How to Access Program Mode.....	29
Hot Keys.....	30
Menu Keys .....	31
Numeric Keys.....	31
Using the Menu System .....	32

Directly Editing Parameters .....	33
Test Mode .....	34
Using the Serial Interface .....	35
Parameter Defaults .....	37
Chapter 4 Quick Setup Guide .....	38
Enter Program Mode .....	38
Choose Quick Setup.....	38
Choose Your Application .....	39
Quick Setup .....	40
Set-up Your Application .....	41
Example 1 Level Control.....	45
Example 2 Sump Control (pump down).....	47
Chapter 5 Parameter Guide .....	49
Menu System .....	49
Top Level Menu .....	49
Application Menu.....	50
Relays Menu .....	51
Pump Advanced Menu .....	52
Digital Inputs Menu.....	53
Float Switch Backup .....	54
Tariff Guard Menu.....	55
Data Logs Menu .....	56
Pumped Volume Menu.....	57
Efficiency Menu.....	58
Display Menu .....	59
mA Output 1 Menu .....	60
mA Output 2 Menu .....	60
Compensation .....	61
Stability Menu .....	61
Echo Processing Menu.....	62

System Menu .....	63
Device Comm Menu .....	64
Test Menu .....	65
Chapter 6 Parameter Listing and Description .....	66
Application Parameters.....	66
Operation .....	66
Dimensions .....	67
Relay Parameters.....	69
Alarms.....	71
Pumps.....	82
Control.....	86
Miscellaneous .....	92
Pump by Time .....	94
Common Relay parameters.....	97
Pump Trips.....	98
Pump "Advanced" Parameters.....	99
Pump Run On .....	99
Starting.....	99
Stopping .....	100
Pump Exercising .....	100
Wall Cling .....	101
Storm.....	101
Rate Method .....	102
Digital Inputs.....	103
Device Fail .....	105
Duty .....	106
Override .....	109
Reset.....	109
Digital Input Parameters .....	109
Digital Input.....	112

Float Switch (FS) Backup .....	114
Common Par .....	114
Digital Input.....	115
Tariff Guard.....	116
Set Up .....	116
Peak Times .....	117
Data Log parameters .....	119
Totaliser Audits .....	119
Temperature.....	119
Pump Logs.....	120
Pumped Volume.....	122
Set Up .....	122
Volume .....	123
Conversion.....	123
Breakpoints.....	128
Tables.....	129
Pump Efficiency.....	130
Set Up .....	130
Display Parameters.....	133
Options.....	133
Failsafe.....	135
Auxiliary.....	136
Totaliser.....	138
Bargraph .....	140
mA Output 1 Parameters .....	141
Range.....	141
Operation .....	142
Setpoint.....	142
mA1 Limits .....	143
mA1 Trim.....	143

mA1 Failsafe .....	144
mA1 Allocation.....	144
mA Output 2 Parameters .....	145
Range .....	145
Operation .....	146
Setpoint.....	146
mA2 Limits .....	147
mA2 Trim.....	147
mA2 Failsafe .....	148
mA2 Allocation.....	148
Compensation Parameters .....	149
Offset.....	149
Temperature.....	149
OVF Persist.....	150
Velocity.....	150
Stability Parameters .....	151
Damping .....	151
Indicator.....	151
Rate.....	151
Filters.....	152
Echo Processing Parameters.....	153
Transducer 1 Status.....	153
Transducer 2 Status.....	154
DATEM Parameters.....	155
System Parameters .....	156
Passcode .....	156
Backup .....	156
System Information .....	156
Date & Time .....	158
LED Colour .....	158



Watchdog.....	159
Daylight Saving Time.....	160
Device Comm. ....	164
RS232 Set Up .....	164
RS 485 Set Up .....	164
Remote Alarm.....	165
Test Parameters .....	167
Simulation .....	167
Hardware .....	168
Chapter 6 Troubleshooting.....	171
Chapter 7 Disposal .....	172
Notes .....	173

## CHAPTER 1: START HERE...

Congratulations on your purchase of a Pulsar Quantum<sup>2</sup>. This quality system has been developed over many years and represents the latest in high technology ultrasonic level measurement and control.

It has been designed to give you years of trouble-free performance, and a few minutes spent reading this operating manual will ensure that your installation is as simple as possible.

### *About this Manual*

**It is important that this manual is referred to for correct installation and operation.** There are various parts of the manual that offer additional help or information as shown.

### *Tips*



TIP: Look for this icon throughout your Pulsar Measurement manual to find helpful information and answers to frequently asked questions.

### *Additional Information*

#### **Additional Information**

At various parts of the manual, you will find sections like this that explain specific things in more detail.

### *References*

#### **See Also**

References to other parts of the manual.

## About the Quantum<sup>2</sup>

The Quantum<sup>2</sup> is a state of the art pump management, and level controller, that provides advanced operating routines suitable for an extremely wide variety of applications. The system combines premium specification with high performance even in the most arduous applications where high turbulence and foam or froth is present.



## Functional Description

The Quantum<sup>2</sup> level and pump controller is a highly developed ultrasonic level measurement system which provides non-contacting sophisticated pump and level control routines suitable for an extremely wide variety of applications.

Easy calibration and maintenance free “fit and forget” performance mean that you can install the Quantum<sup>2</sup> pump controller rapidly and with confidence. Ten user-definable relays with adjustable, individual on and off points. Seven user-definable digital inputs, 2 x isolated mA output, RS 232 and intelligent performance logging software features provide the user with a superior pump management system and comprehensive level measurement information.

The Quantum<sup>2</sup> operates on the principle of timing the echo received from a measured pulse of sound transmitted in air and utilises the unique DATEM software (Digital Adaptive Tracking of Echo Movement).

This is an entirely new digital mapping technique developed especially for the Pulsar ultra range. It gives the system the edge when identifying the "true target level" in the face of competing echoes from pipes, pumps, or other obstructions. When coupled with the powerful, long range abilities of all the dB transducer range, including the new dBR16 mmWave radar, the Quantum<sup>2</sup> level and pump controller has no equal.

The Quantum<sup>2</sup> can measure from zero to 40m from the transducer to the surface being monitored, dependent on the transducer used.

The Quantum<sup>2</sup> can show level, space, distance, average level and differential level on the display. The relays can be programmed to activate alarms, pump starters, or other control equipment. In addition, the digital inputs can be used to modify pump and control regimes in order to optimise performance. There are two isolated 4-20 mA outputs that can be connected to a chart recorder or PLC, to monitor level, space, distance, or pumping rate, independently from that shown on the display. There is an RS232 port, so that the Quantum<sup>2</sup> can be operated remotely by a PC or other equipment.

The Quantum<sup>2</sup> is programmed by the built-in keypad or by PC via the RS 232 Serial Interface (optional). All the parameters are stored in non-volatile memory, so are retained in the event of power interruption. A second backup copy of all parameters can also be retained in the Quantum<sup>2</sup>, in case a previous set of parameters needs to be restored.

## Product Specification

### PHYSICAL

<b>Fascia Mount Outside Dimensions</b>	200 x 112 x 108 mm
<b>Weight</b>	Nominal 1.3kg
<b>Enclosure Material/Description</b>	Stainless steel with Polycarbonate UL94 –V0 front and bezel
<b>Transducer Cable Extensions</b>	2-core screened
<b>Maximum Separation</b>	1000m (3,280 ft), 500m (1,640 ft) for mmWave

### ENVIRONMENTAL

<b>IP Rating (Wall)</b>	IP64
<b>Max. &amp; min. temperature (electronics)</b>	-20 °C to +50 °C
<b>Flammable atmosphere approval</b>	Safe area: compatible with approved dB transducers (see transducer spec' sheet)
<b>CE Approval</b>	See EU Declaration of Conformity

### PERFORMANCE

<b>Accuracy</b>	0.25% of the measured range or 6 mm (whichever is greater). mmWAVE ± 2mm.
<b>Resolution</b>	Dependant on application and sensor used, typically with standard ultrasonic transducer, 0.1% of the measured range or 2 mm (0.08") (whichever is greater).
<b>Max. Range</b>	Dependant on transducer (maximum 40m dB40)
<b>Min. Range</b>	Dependent upon application and transducer (minimum zero dB Mach3)
<b>Rate Response</b>	Fully adjustable

### ECHO PROCESSING

<b>Description</b>	DATM (Digital Adaptive Tracking of Echo Movement)
--------------------	---

**OUTPUTS**

<b>Analogue I/O</b>	2 off Isolated (floating) outputs (to 150V) of 4-20 mA or 0-20 mA into 500Ω (user programmable and adjustable) 0.1% resolution
<b>Digital output</b>	Full Duplex RS232
<b>Volt free contacts, number, and rating</b>	5 form "C" (SPDT) rated at 5A at 115V AC (Relays 1, 2, 3, 4,& 5) and 5 form "C" (SPDT) rated at 3A at 115V AC (Relays 6, 7, 8, 9 & 10)
<b>Display</b>	6 digits plus 12-character text, plus bar graph with direction indicators, remote communicator identifier, and program/run/test mode indicators

**DIGITAL INPUTS**

<b>Min. Input voltage 4.5V DC</b>	Max. Input Voltage 30VDC (Max Current 3mA per Input) 24VDC Input Supply maximum total current 24mA.
-----------------------------------	--

**PROGRAMMING**

<b>On-board programming</b>	By integral keypad
<b>PC programming</b>	Via RS232
<b>Programming security</b>	Via passcode (user selectable and adjustable)
<b>Programmed data integrity</b>	Via non-volatile RAM, plus backup

**SUPPLY**

<b>Power Supply</b>	115V AC + 5% / -10% 50/60 Hz, 230V AC + 5% / -10% 50/60 Hz, DC 18 - 36V 10W maximum power (typically 6W)
<b>Fuses</b>	100 mA at 170-240V AC (fitted as standard to wall units). 200 mA at 85-120V AC (fitted as standard to fascia units)

Pulsar Measurement operates a policy of constant development and improvement and reserve the right to amend technical details, as necessary.

**EU Certificate of Conformity****EU DECLARATION OF CONFORMITY****PULSAR *Ultra controllers range***

This declaration of conformity is issued under the sole responsibility of the manufacturer

Relevant directive(s)	2014/30/EU - EMC directive and its amending directives. 2014/35/EU - Low Voltage directive and its amending directives. 2011/65/EU - RoHS directive and its amending directives.
Manufacturer's name	Pulsar Process Measurement Ltd.
Manufacturer's address	Cardinal Building, Enigma Business Commercial Centre, Sandy's Road, Malvern, Worcestershire, WR14 1JJ, UK.
Apparatus	System controller with optional communications.
Models	Pulsar Ultra wall mount, including Ultra 3, Ultra 5, Advanced rake master 2.2, Oracle CSO 2.1, Ultra 3 i.s. . Pulsar Ultra Fascia mount including Ultra 3, Ultra 5, Quantum, Zenith. Pulsar Ultra 4, wall & fascia mount. Ultra Lite, wall & fascia mount. Pulsar Ultra rack mount. Pulsar Ultra Twin, wall & fascia mount.
Type of equipment	Measurement and process control.
Standards applied	EN 61010-1:2010+A1:2019 Safety requirements for electrical equipment for measurement, control and laboratory use. EN 61326-1:2013 EMC, equipment class industrial.

I declare that the apparatus named above has been tested and complies with the relevant sections of the above referenced standards & directives.

Signed for and on behalf of:

A handwritten signature in black ink, appearing to read "Tim Brown".

Date: 7th April 2021.

Rev. 5.0 .

Name & function: Tim Brown, electronics engineer.

Pulsar Process Measurement Ltd.

## CHAPTER 2 QUANTUM<sup>2</sup> INSTALLATION

### *Unpacking*

#### **Important Information**

All shipping cartons should be opened carefully. When using a box cutter, do not plunge the blade deeply into the box, as it could potentially cut or scratch equipment components. Carefully remove equipment from each carton, checking it against the packing list before discarding any packing material. If there is any shortage or obvious shipping damage to the equipment, report it immediately to Pulsar Process Measurement Limited.

### *Power Supply Requirements*

The Quantum<sup>2</sup> can operate from AC supply or from a DC battery. The **AC** is either **115V+5%/-10% 50/60Hz** or **230V +5%/-10% 50/60Hz**, depending on the position of the selector switch. The **DC** is **18-36V**. In all cases the Quantum<sup>2</sup> will typically consume 6W of power, with a maximum of 10W.



## Location

The Quantum<sup>2</sup> must be mounted in a non-hazardous (safe) area, and the transducer fitted in the hazardous area

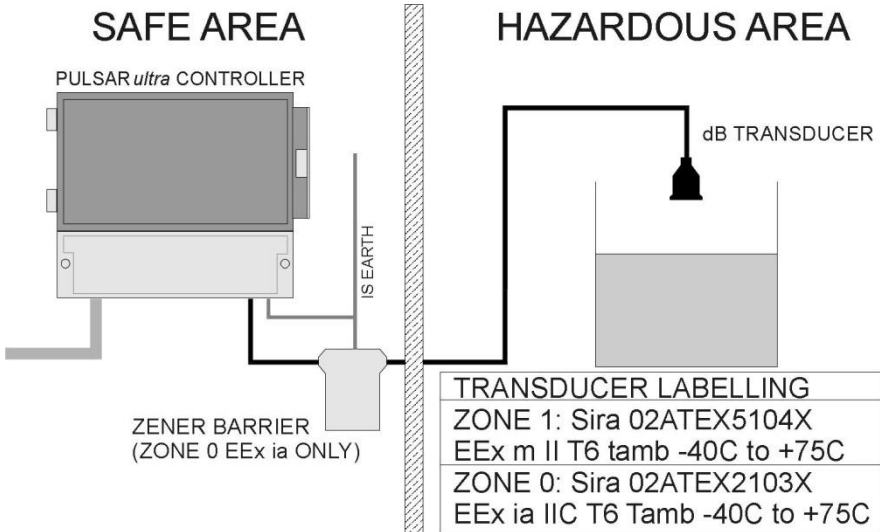

When choosing a location to mount the enclosure, bear in mind the following:

- Ensure that the Quantum<sup>2</sup> Lite is installed in a "Safe", non-hazardous area.
- For a clear view of the LCD display, it is recommended that it is mounted at eye level.
- The mounting surface is to be vibration free.
- The ambient temperature is between -20°C and 50°C.
- There should be no high voltage cables or inverters nearby,

### Important Information

All electronic products are susceptible to electrostatic shock, so follow proper grounding procedures during installation.

## Dimensions

### Fascia Mount

The dimensions of the wall fixing holes are as shown below:

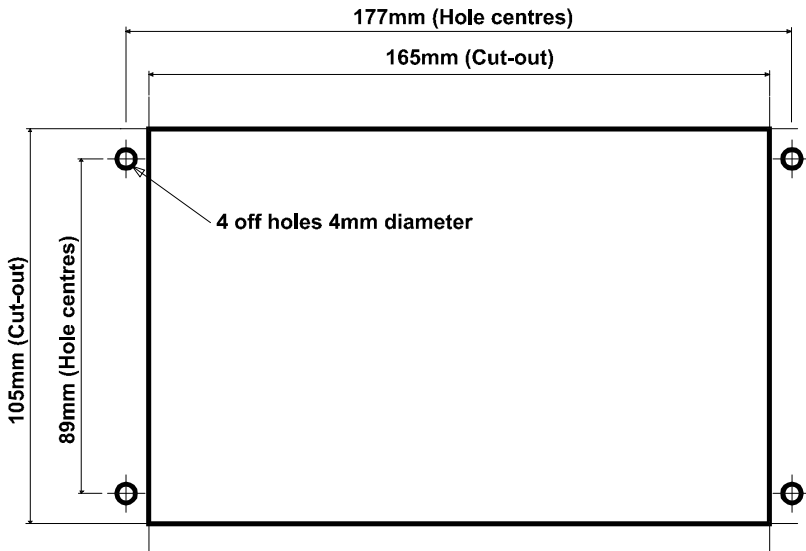

The full dimensions of the fascia mount enclosure are as shown below:

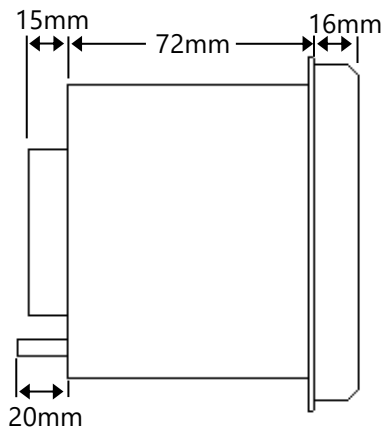
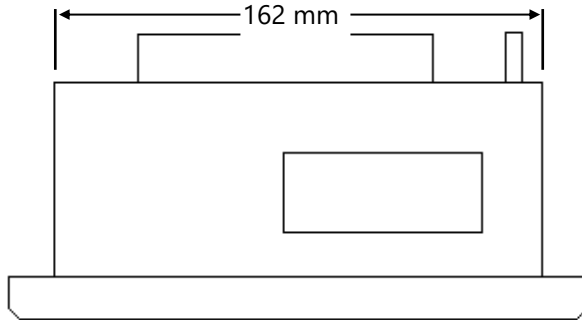
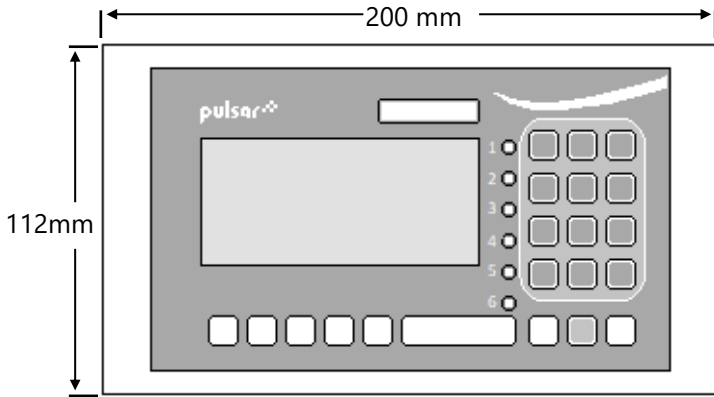

**Terminal connection details**

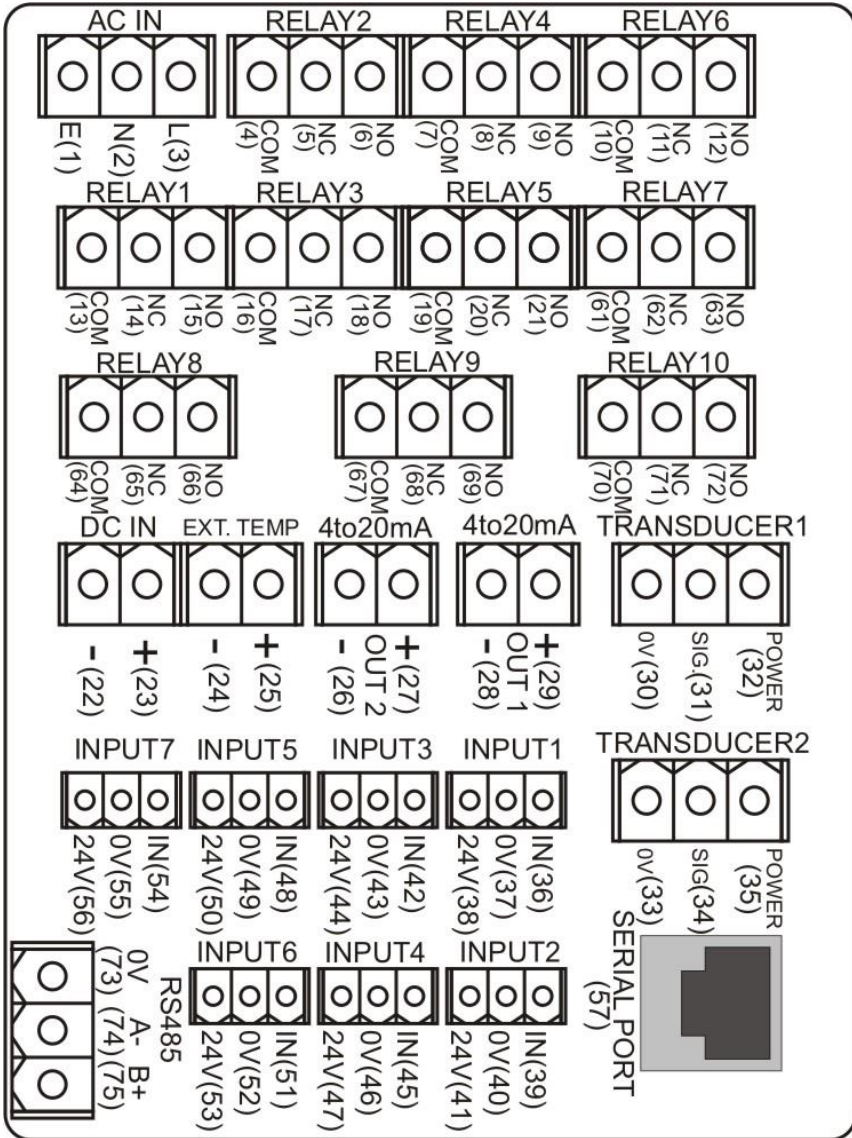

## Power

The Quantum<sup>2</sup> can operate from mains AC and automatically from DC or battery backup in the event of power failure or can be operated permanently from DC or batteries.

## Transducer(s)

The transducer should be installed, and connected, in accordance with the installation instructions contained in the Transducer User Guide.

Wire the transducer to the Quantum<sup>2</sup>'s transducer terminals, as follows:

### Transducer 1

TERMINAL CONNECTION DETAILS			
Red: Power	White: Signal	Black: 0Volts	Green: Screen
32	31	30	30

### Transducer 2

TERMINAL CONNECTION DETAILS			
Red: Power	White: Signal	Black: 0Volts	Green: Screen
35	34	33	33

When using 2-core screened extension cable, the Black and Green wires of the transducer should be connected to the screen of the extension cable which in turn should be connected to the appropriate 0 volts' terminal of the Quantum<sup>2</sup>.

## ATEX

For **Zone 1** applications a transducer certified to **Sira 02ATEX5104X** is used, and must be supplied via a 4000A breaking fuse, which is fitted as standard to the Quantum<sup>2</sup>.

For **Zone 0** a transducer certified to **Sira 02ATEX2103X** is used, which must be connected to the Quantum<sup>2</sup> controller via an external Zener barrier.

When using the Quantum<sup>2</sup> in a **single transducer** mode, to measure space, level or distance, the transducer should be **connected to Transducer 1** input terminals. In applications where it is required to measure **Differential**, then the **upstream** transducer should be **connected to Transducer 1** input terminals and the **downstream** transducer to **Transducer 2** input terminals. In cases where the Quantum<sup>2</sup> is required to measure **Average**, transducers can be **connected as required**.

### *Relay Outputs*

The ten user definable relays can be programmed for a variety of alarms, pump control, or other process functions. Relays 1, 2, 3 4 and 5 contacts are all rated at 5A at 240V AC, whilst Relay 5, 6, 7, 8, 9 and 10 contacts are rated at 3A at 240V AC. All connections should be such that the short circuit capacity of the circuits to which they are connected, is limited by fuses rated so that they do not exceed the relay rating.

### *Current Output*

This is an isolated (floating) mA output (to 150 V), of 4 - 20mA or 0 - 20mA, and the load should not exceed 500  $\Omega$ .

### *Temperature Input*

The external temperature sensor allows more localised compensation of the measured distance due to changes in temperature.

There are 2 models Type A: -25°C to 50°C, and Type B: -25°C to 125°C

The temperature sensor should be placed close to the point of the measurement.

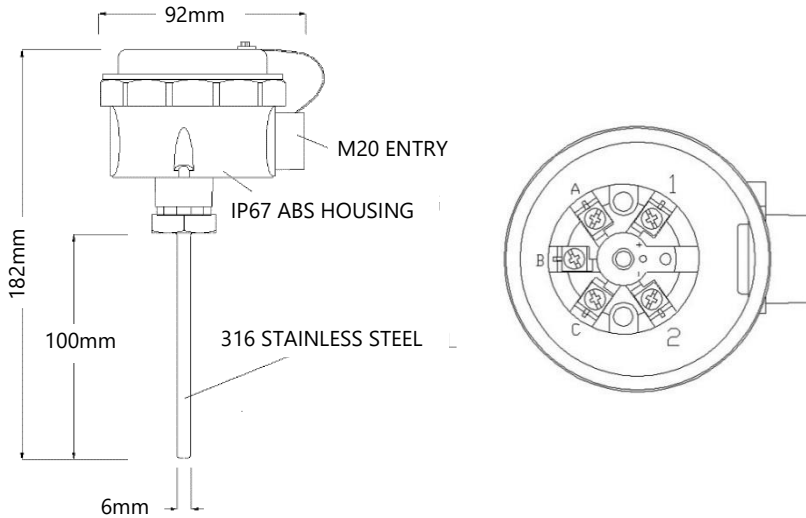

The Temperature sensor connections are as follows:

DESCRIPTION	TEMPERATURE SENSOR	QUANTUM <sup>2</sup>
Power Supply	Terminal 1	Terminal 25
Return	Terminal 2	Terminal 24

**Temp Source** (P852), should be set to option 4 or 5 depending on the sensor range, set 4 for type A and 5 for type B (see above), the range is specified on the label of the sensor.

This feature is available as an option only, please consult Pulsar for further details.

### **Digital Inputs**

Where the Quantum<sup>2</sup> is required to provide power for a Device Input the appropriate Digital Input should be wired between the 24VDC supply terminal and the IN terminal. (TOTAL maximum current available, for all seven digital inputs, from the 24VDC supply is 24mA). When Device Inputs are self-powered, connection of the device should be made between the Common terminal and the IN terminal. (Min Input voltage 4.5VDC, and Maximum Input voltage 30VDC with a maximum current of 3mA).

### **RS2323 Serial Interface**

If required, you can connect to the serial interface to operate your Quantum<sup>2</sup> remotely.

### **Voltage selector and fuse location**

The voltage selector switch and mains fuse, is located under the removable cover at the bottom of the unit, as illustrated below.

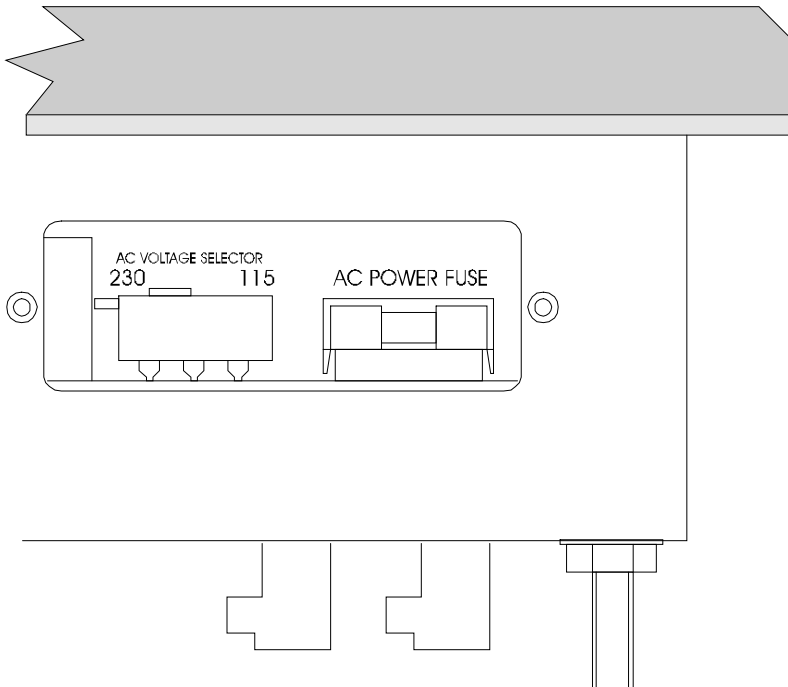



### Important Information

Before applying AC power (mains), make sure you have correctly selected the voltage selector switch. In the case of the Fascia mount model this is located under the removable cover at the bottom of the unit, as detailed in the preceding pages.

Please note that all Fascia units are set to 115 volts AC with a 200mA fuse fitted, and wall units are supplied set to 230 volts AC for safety reasons, and a 100mA fuse fitted as standard.

Never operate the Quantum<sup>2</sup> with the terminals access cover removed.

An external switch or circuit breaker should be installed near to the Quantum<sup>2</sup> to allow the supply to be removed during installation and maintenance. In addition, the relay contacts should also have a means of isolating them from the unit.

Interconnecting cables must be adequately insulated in accordance with local regulations. Strip back 30 mm of the outer insulation of the cable. Strip 5 mm of insulation from the end of each conductor. Twist all exposed strands of the conductor together. Insert the stripped conductor into the terminal block as far as it will go and tighten the terminal block screw. Ensure that all strands are firmly clamped in the terminal block and that there is no excess bare conductor showing, and no stray strands.



### **DON'T FORGET**

**Make sure you move the voltage selector switch to the correct position for your power supply**

### Important Information

If the equipment is installed or used in a manner not specified in this manual, then the protection provided by the equipment may be impaired.

### **Preparation for Operation**

Before switching on, check the following:

- ✓ The Quantum<sup>2</sup> is mounted correctly and is in a 'safe' area.
- ✓ The power supply is correctly installed.
- ✓ The voltage selector switch is in the correct position.
- ✓ The relays are connected correctly.

### **Maintenance**

There are no user serviceable parts inside Quantum<sup>2</sup>, except the mains fuse. If you experience any problems with the unit, then please contact Pulsar Measurement for advice.

To clean the equipment, wipe with a damp cloth. Do not use any solvents on the enclosure.

#### **Important Information**

The unique DATEM software comes into operation as soon as power is applied and is designed to monitor a **moving level** or **target** with the **transducer** in a **fixed position**.

If, after any period of use, it should become necessary to move the transducer, for any reason, from its original operating position, switch off the Quantum<sup>2</sup>, before proceeding, in order to prevent any undesirable updates to the DATEM trace. If after moving the transducer the reading is not as expected, please refer to Chapter 6 Troubleshooting.

## CHAPTER 3 HOW TO USE YOUR QUANTUM<sup>2</sup>

### Operating the Controls

If you are already familiar with the setup of the Quantum<sup>2</sup>, go straight to the quick setup guide in Chapter 4.

#### Display

The display provides information on the current mode of operation, and status of the remote communication. Whilst in the Run Mode it will display the current level reading and its units of measure, along with status messages with regards to the Transducer, Echo reception and Fail Safe Mode. Additionally, it can be programmed to provide status messages on alarms, pumps etc. When in the Program mode the display is used to read information on the Menu System, Parameter Number and parameter details and values, which can be entered. During Test Mode, the display is used to monitor the simulated level. A bar graph is also provided which will provide a visual reading of the level, in percentage of span.

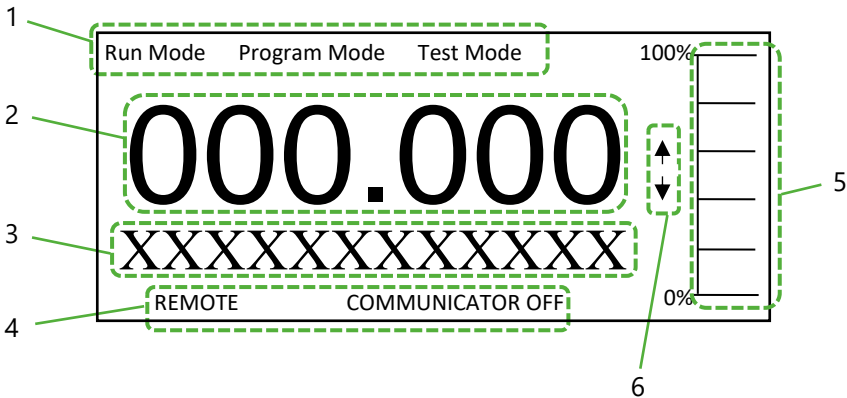

1. Displays the current mode of operation
2. Main 6-digit display:
  - Run Mode;** current measurement displayed, dependent on mode and measurement units chosen, and value of hotkey selected.
  - Program Mode;** displays parameter number and values entered for parameters.
  - Test Mode;** displays simulated level.

3. Auxiliary Display, scrolling twelve-digit display.  
**Run Mode;** displays measurement units, status messages on signal and transducer, details of Hot Key function selected. It can be also programmed to provide notification messages on alarms and pumps etc. For full details please refer to Display Parameters in the relevant parameter listing.  
**Program Mode;** displays menu and sub menu headings, parameter details and options.
4. Communicator status, this displays the status of remote PC connection and velocity sensor operation.
5. Bar graph display, this gives visual indication of measurement in % of span.
6. Level indicators:  
**Run Mode;** indicates in which direction the level is moving.  
**Program Mode;** indicates at which level of the menu system you are at.

There are two main operating modes for your Quantum<sup>2</sup>, **Run Mode** and **Program Mode**. There is also a **Test Mode**, used for checking the set-up. All modes are now described.

### **Run Mode**

This mode is used once the Quantum<sup>2</sup> has been set up in program mode. It is also the default mode that the unit reverts to when it resumes operation after a power failure.

When the Quantum<sup>2</sup> is switched on for the first time, it will display, in metres, the distance from the transducer face to the target. All relays by default are switched off.

After programming is complete, any relays that are set will operate when the level reaches the relevant setpoint, and the LED's will change colour (unless specifically switched off).

### *Program Mode*

This mode is used to set up the Quantum<sup>2</sup> or change information already set. You must use either the built-in keypad (standard) or, alternatively the unit can be set up with a PC via the RS232 Serial Interface.

Entering a value for each of the parameters that are relevant to your application provides all the programming information.

### *How to Access Program Mode*

To enter program mode on the Quantum<sup>2</sup>, you simply enter the passcode, via the keypad, followed by the ENTER key. The **default passcode** is **1997**, so you would press the following:









#### **Important Information**

There is a time-out period of 15 minutes when in program mode. After which time the run mode will resumed if you do not press any key.





**Hot Keys**

There are five hot keys on the keypad, which can be used to quickly access common parameters for viewing only, while in Run Mode. Pressing the hot key once will display the first parameter, then repeated pressing will display the others, then the Quantum<sup>2</sup> reverts to Run Mode. In program mode, they have different functions, the functions are shown below.

HOT KEY	RUN MODE	PROGRAM MODE
	Total pump running hours, and individual pump running hours	Not used with Quantum <sup>2</sup>
	Displays echo confidence, echo strength, height above loss limit (HALL), average noise, peak noise and temperature	Not used with Quantum <sup>2</sup>
	Total number of pump starts and individual pump starts.	Reset parameter to default setting
	Instantaneous mA output	Not used with Quantum <sup>2</sup>
	Dependent on application. Displays distance, level, space, volume or rate of change of level.	Toggle relay setpoints between units of measure and % of span.
	Reset for digital Inputs	Takes you to the last parameter edited when you first enter program mode.
	Shows details of function type, firmware revision and serial number	Enter decimal point.

### Menu Keys

The menu keys have the following functions:

HOT KEY	FUNCTION
	1) Arrow keys for moving left and right around the menu system.
	2) Used in test mode to simulate the level moving up and down.
	1) Used to confirm each action (e.g. select a menu option) 2) Used to confirm questions asked by the Quantum <sup>2</sup> , such as before restricting factory defaults.
	Used to navigate up a level in the menu system, and back to run mode. Used to cancel a value entered in error

### Numeric Keys

These keys are used for entering numerical information during programming.

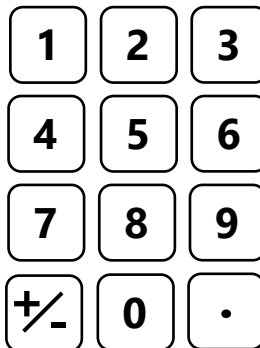

There are two means of editing parameters, directly or using the menu system. Each is now described.

### Using the Menu System

The menu system has been designed to make the changing of parameters very simple. There are two levels of menu: **Main Menu** and **Sub Menu**.

On the display, there is a line of text that displays the menu system. Pressing the arrow keys scrolls the display between the top-level menu items, (as the example shown below, starting at Quick Setup).

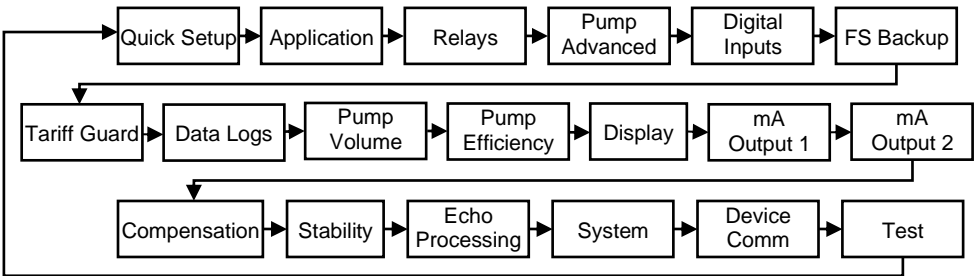

As you press the cursor keys to scroll left and right between these, you can press ENTER at any time, to select the desired menu heading, and take you to the sub-menu.

Each of these options, along with their sub-menus, are described later in this manual. When you move down into the sub-menu, you can scroll round using the arrow keys, press ENTER to go to the required section of parameters.

Once you have reached the relevant section, scroll through the parameters, and enter the necessary information. To enter the information, use the numeric keys and then press ENTER, you will then see the message **"Saved!"** If you press CANCEL, then the change you made will not be saved, and the message **"Unchanged!!"** will be displayed.

When you have finished, press CANCEL to go back to the previous level. When you have reached the top level, then the Quantum<sup>2</sup> will ask for confirmation before allowing you to go back into run mode. This is done by pressing ENTER at the display prompt.



### Important Information

You can tell which part of the menu system you are in, as the up/down level indicators, (arrows) next to the bar graph will indicate as follows:

- **Top level menu: Down arrow on**, to indicate you can move down.
- **Sub-menu: Up and Down arrows on**, to indicate you can move up to the top level, and down to parameter level.
- **Parameter Level: Up arrow on**, to indicate you can move up to sub-menu level.
- **Parameter Editing: No arrows on**.

### Directly Editing Parameters

If you already know the number of the parameter, that you wish to look at or edit, simply type the number in at any time while you are in the menu system. Thus, if you are in either the menu or sub-menu level by pressing a numeric key, you can enter the parameter number directly and jump straight there. You cannot type a parameter number whilst at parameter level, only at one of the two menu levels.

When you are at a parameter, the text line rotates automatically displaying the parameter name, number, the applicable units, and the maximum and minimum figure you can enter. The top line shows the value you are setting.

Once you have accessed a parameter, you can either just look at it, or change it.

Once a parameter has been changed, press 'ENTER' and you will see the message "**Saved!**". If you press 'CANCEL', then the change you made will not be saved, and the message "**Unchanged!!**" will be displayed.



You can jump straight to the last parameter you edited, by pressing '+/-' when you first enter program mode.

## Test Mode

Test mode is used to simulate the application and confirm that all parameters and relay setpoints have been entered as expected. During simulation, there is a choice of whether the relays will change state (hard simulation) or not (soft simulation), but the LED's will always change colour as programmed, and the mA output will change in accordance to the chosen mode of operation. If you wish to test the logic of the system that the **relays are connected** to then select **hard simulation**, but if you **do not wish to change the relay state**, then select a **soft simulation**.

There are two simulation modes, automatic and manual. Automatic simulation will move the level up and down between empty level or the pre-determined **Start Level (P983)** and Pump/Control relay switch points, if you wish to change the direction of the level movement e.g. to go beyond relay setpoints, this can be done by using the arrow keys. In manual simulation, using the arrow keys will allow you to move the level up and down as required.

To enter simulation, first go to program mode. Using the menu system, select menu item '**Test**', then sub-menu item '**Simulation**'. Simply change the value of the parameter **P980** to one of the following:

- 1= Manual soft simulation
- 2= Automatic soft simulation
- 3= Manual hard simulation
- 4= Automatic hard simulation

To return to program mode, press 'CANCEL' and test mode will end.

When in manual simulation, by default test mode will move the level by 0.1m steps. Altering the **increment (P981)** will change this value.

In **automatic** mode, the rate at which the level moves up and down is set by the increment (P981 in metres, and the **rate (P982)** in minutes, which can be changed to make the level move up and down faster. E.g. if increment (P981) is set for 0.1m and rate (P982) is set to 1 min then the level will increase or decrease at a rate of 0.1m/min. To make the simulated level move slower, decrease the value in increment (P981) or increase the value in rate (P982). To make the simulated level move faster, increase the value in increment (P981) or decrease the value in rate (P982).

### Using the Serial Interface

The RS232 serial interface is used to communicate between the Quantum<sup>2</sup> Lite and a PC using the optional Ultra PC and other associated Pulsar software packages, to obtain information such as data logging and view echo traces upload, download and save parameter files. In addition, it can also be used to control or obtain information using a standard PC or other computer base equipment. To do so, the settings for control are as follows: **baud rate 19,200, 8 data bits, no parity, 1 stop bit.**

The device should be connected as shown in [Chapter 2 Quantum<sup>2</sup> Installation](#).

To use the device remotely, you need to **log on** to start, and **log off** when finished. When **logged on**, Quantum<sup>2</sup> Lite will show '**Remote ON**' on the display, and "**Communicator OFF**" when **logged off**.

*All commands should be followed by a carriage return.* When logged on, the unit will respond either OK (or a value) if the command is accepted, or NO if it is not.

To log on, send the command

/ACCESS:pppp where pppp is the passcode (P922).

To log off, send the command

/ACCESS:OFF

To read a parameter value, send the command

/Pxxx where xxx is the parameter you wish to read, and the Quantum<sup>2</sup> will respond with the parameter value.

To set a parameter, send the command

/Pxxx:yy where xxx is the parameter number, and yy is the value you wish to set it to.

Other commands you can use are:

/DISTANCE (shows current distance)

/LEVEL (shows current level)

/SPACE (shows current space)

/RATE (shows current rate)

/VOLUME (shows current volume)

/TEMP (shows current temperature)

/CURRENTOUT1 (show the mA output 1 value)

/CURRENTOUT2 (show the mA output 2 value)

/BACKUP1 (take backup of parameters to area 1)

/BACKUP2 (take backup of parameters to area 2)

/RESTORE1 (restore parameters from area 1)

/RESTORE2 (restore parameters from area 2)

Please consult Pulsar Measurement or contact your local Pulsar representative for further details and a full list of available commands.

## Parameter Defaults

### Factory Defaults

When first installing the Quantum<sup>2</sup>, or subsequently moving or using the unit on a new application, before proceeding to program the unit for its intended application it is recommended that you ensure that all parameters are at their default values by completing a **Factory Default P930**, as described in the relevant unit type **parameter guide**.

When you first switch the Quantum<sup>2</sup> on, it will be reading the **distance** from the face of the transducer to the surface. It will be indicating in **metres**, as shown on the display. All relays are set OFF.

The **date (P931)** and **time (P932)** in the Quantum<sup>2</sup> were set at the factory, but may need checking, and amending if, for example the application is in a time zone other than GMT, see relevant parameter listing for full details.



In some applications, it is easier to empty the vessel, take a reading from the Quantum<sup>2</sup> for distance and then setup the empty level to this figure.

Once you are satisfied with the installation, and Quantum<sup>2</sup> is reading what you would expect in terms of distance from the face of the transducer to the material level, then you can proceed with programming, for the intended application. It is sensible to program all of the required parameters at the same time. The system will be then set-up.

**Note:** *The span is automatically calculated from the empty level, so the empty level should be entered first.*

## CHAPTER 4 QUICK SETUP GUIDE

This quick set-up guide shows you how to get up and running within a few minutes of installing your Quantum<sup>2</sup>.

### Enter Program Mode

First you need to go from run mode into program mode. Assuming the passcode is the default 1997, then you should enter the following on the keypad:



### Choose Quick Setup

Now you need to go into the quick setup. You will see on the menu the words 'Quick Setup', which is the first item on the menu system. Try pressing the two arrow keys to see some more menu options, but return to Quick Setup, and press

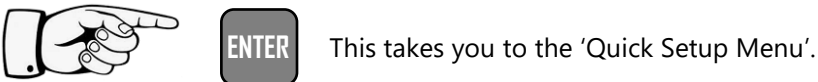

This takes you to the 'Quick Setup Menu'.

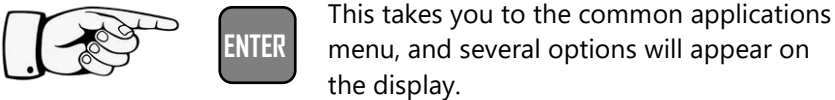

This takes you to the common applications menu, and several options will appear on the display.

### Important Notice

If you have already setup a common application, then there will be a number shown other than 0, and you will see messages showing what the current setup is. If you want to reset this and start again, press 0 (which will reset all the quick setup parameters), otherwise pressing ENTER will allow you to edit the parameters that have been set.

### *Choose Your Application*

There are four categories of application, which are all described at the end of this chapter. They are **level**, **pump down** (sump control), **pump up** (reservoir control) or **customised**, all with the choice of alarms and a number of pumps, dependant on application.

If you want to set-up a basic **level monitoring** application, as described in the following **example 1**, then choose 1. You then need to decide the **number of alarms** required and their **function** and choose the appropriate options.

If you want to set-up a **pump down** (sump control) application, as described in the following **example 2**, then choose 2. You then need to decide the **number of pumps** required the **pump duty** and any requirement for **alarms** and choose the appropriate options.

If you want to set-up a **pump up** (reservoir control) application, then choose 3. You then need to decide the **number of pumps** required the **pump duty**, and any requirement for **alarms**, and choose the appropriate options.

In certain cases the Quick Setup Menu has been **customised** for particular customer specific applications, to choose one of these options press 4 and select the appropriate **customised** application and enter the details required as prompted.

Once you have chosen your application you will be asked a series of questions which are answered by choosing the appropriate option as detailed in the flow charts that follow. Once all the questions have been answered you will be prompted to provide further information, as detailed in the tables that follow, in order to complete the programming of the unit.

**Quick Setup**

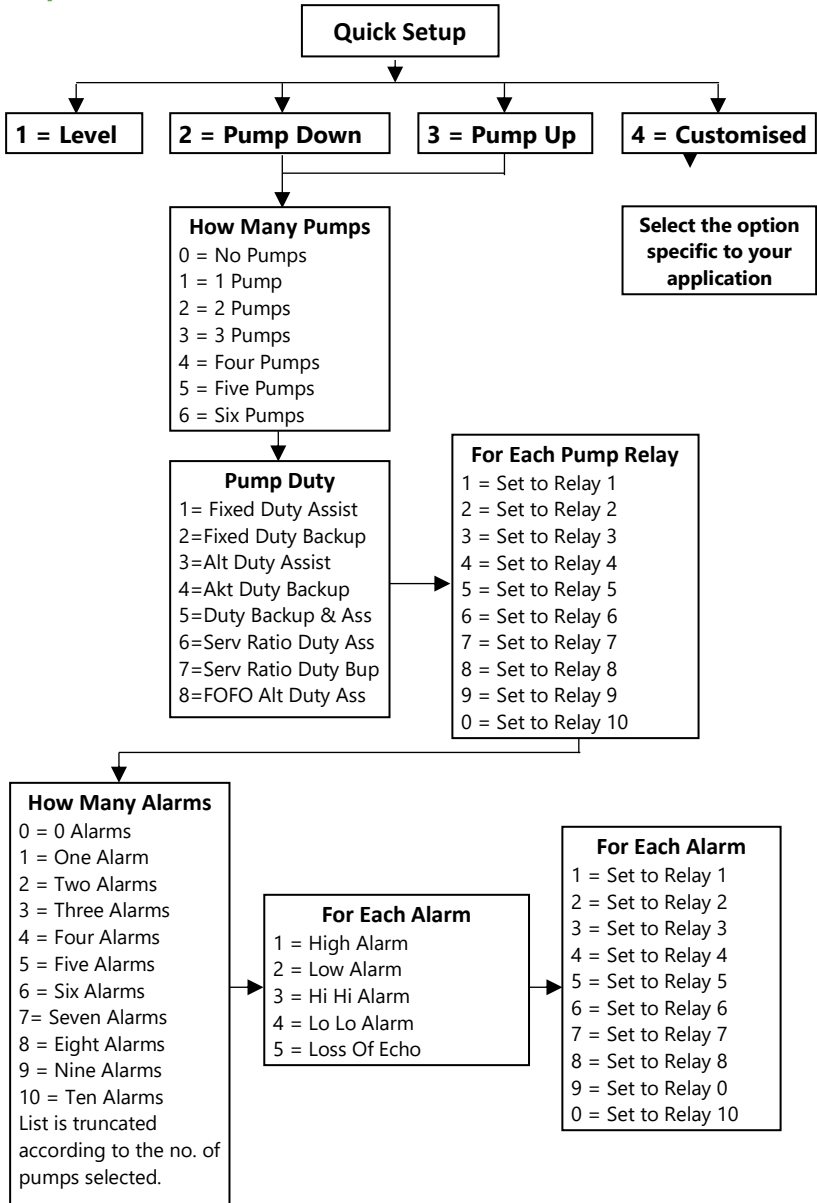



### Important Notice

The maximum number of relays that can be allocated, via the Quick Setup, for use as ‘alarms’ or ‘pump’ is six, if you require to allocate additional relays to ‘alarms’ or ‘pump’ this can be achieved by accessing the Relay Menu and programming additional relays as required.

### Set-up Your Application

Once you have chosen the application, you will see a ‘**Wait...**’ message while the parameters are all calculated and stored. Next you will see the parameters needed to finalise your application, in turn, as shown below. If you know you don’t need to change from the default, you can use the right arrow key to scroll through them, but if you want to view or change each one, just press ENTER.

PARAMETER	DEFAULT	DESCRIPTION
P101 Transducer	2 = dB6	Type of transducer being used.
P104 Measurement Units	1 = metres	Select units to be used for programming measurement information.
P105 Empty Level	6m	Distance from the face of the transducer to the material at the bottom of the vessel.
P106 Span	5.7m	Distance from the empty level (0% full) to span (100% full).

### For More Options Hit Enter..

Now you will see a scrolling message that says, ‘For more Options **Hit Enter**’. If you press ENTER, you will then see more parameters, specific to the application you have chosen, these are all factory pre-set. If you press any other key you will return to the Quick Setup menu, where you can press CANCEL to return to run mode.

If you want to change any of the factory pre-set parameters, then you can do so, referring to the relevant page of Chapter 5, in this handbook for detailed information. The parameters concerned are shown below.

PARAMETER	DEFAULT	DESCRIPTION
P213 / P214 Relay 1 ON/OFF setpoints	Factory preset as a % to appropriate level according to the span already entered. See tables below	Either Alarm or Level control. Depends on application.
P223 / P224 Relay 2 ON/OFF setpoints	Factory preset as a % to appropriate level according to the span already entered. See tables below	Either Alarm or Level control. Depends on application.
P233 / P234 Relay 3 ON/OFF setpoints	Factory preset as a % to appropriate level according to the span already entered. See tables below	Either Alarm or Level control. Depends on application.
P243 / P244 Relay 4 ON/OFF setpoints	Factory preset as a % to appropriate level according to the span already entered. See tables below	Either Alarm or Level control. Depends on application.
P253 / P254 Relay 5 ON/OFF setpoints	Factory preset as a % to appropriate level according to the span already entered. See tables below	Either Alarm or Level control. Depends on application.
P263 / P264 Relay 6 ON/OFF setpoints	Factory preset as a % to appropriate level according to the span already entered. See tables below	Either Alarm or Level control. Depends on application.
P830 mA Out Range	2 = 4 to 20mA	Determines the mA output range. 0 = Off, 1 = 0 to 20mA, <b>2 = 4 to 20mA</b> , 3 = 20 to 0mA, 4 = 20 to 4mA.
P870 Fill Damping	10m/min	Rate of maximum fill rate (set above the actual fill rate of the vessel).
P871 Empty Damping	10m/min	Rate of maximum empty rate (set above the actual rate of the vessel).

The default values used for determining the relay setpoints, when setting Alarm relays, via the Quick Setup menu are entered as a % of span and are as follows:

<b>APPLICATION</b>	<b>NO. OF PUMPS</b>	<b>PUMP NUMBER</b>	<b>ON SETPOINT</b>	<b>OFF SETPOINT</b>
Pump Down	One	Pump 1	50%	20%
Pump Down	Two	Pump 1	50%	20%
		Pump 2	70%	20%
Pump Down	Three	Pump 1	50%	20%
		Pump 2	60%	20%
		Pump 3	70%	20%
Pump Down	Four	Pump 1	40%	20%
		Pump 2	50%	20%
		Pump 3	60%	20%
		Pump 4	70%	20%
Pump Down	Five	Pump 1	40%	20%
		Pump 2	50%	20%
		Pump 3	60%	20%
		Pump 4	70%	20%
		Pump 5	75%	20%
Pump Down	Six	Pump 1	40%	20%
		Pump 2	50%	20%
		Pump 3	60%	20%
		Pump 4	70%	20%
		Pump 5	75%	20%
		Pump 6	80%	20%

APPLICATION	NO. OF PUMPS	PUMP NUMBER	ON SETPOINT	OFF SETPOINT
Pump Up	One	Pump 1	50%	80%
Pump Up	Two	Pump 1 Pump 2	50% 30%	80% 80%
Pump Up	Three	Pump 1 Pump 2 Pump 3	50% 40% 30%	80% 80% 80%
Pump Up	Four	Pump 1 Pump 2 Pump 3 Pump 4	60% 50% 40% 30%	80% 80% 80% 80%
Pump Up	Five	Pump 1 Pump 2 Pump 3 Pump 4 Pump 5	60% 50% 40% 30% 25%	80% 80% 80% 80% 80%
Pump Up	Six	Pump 1 Pump 2 Pump 3 Pump 4 Pump 5 Pump 6	60% 50% 40% 30% 25% 20%	80% 80% 80% 80% 80% 80%

RELAY FUNCTION	RELAY ID	ON SETPOINT	OFF SETPOINT
Alarm	HiHi	90%	85%
Alarm	High	85%	80%
Alarm	Low	10%	15%
Alarm	LoLo	5%	10%

### Example 1 Level Control

A vessel, containing liquid that has a variation in level that is to be monitored, with a high level alarm set on Relay 1 and low level alarm set on Relay 2.

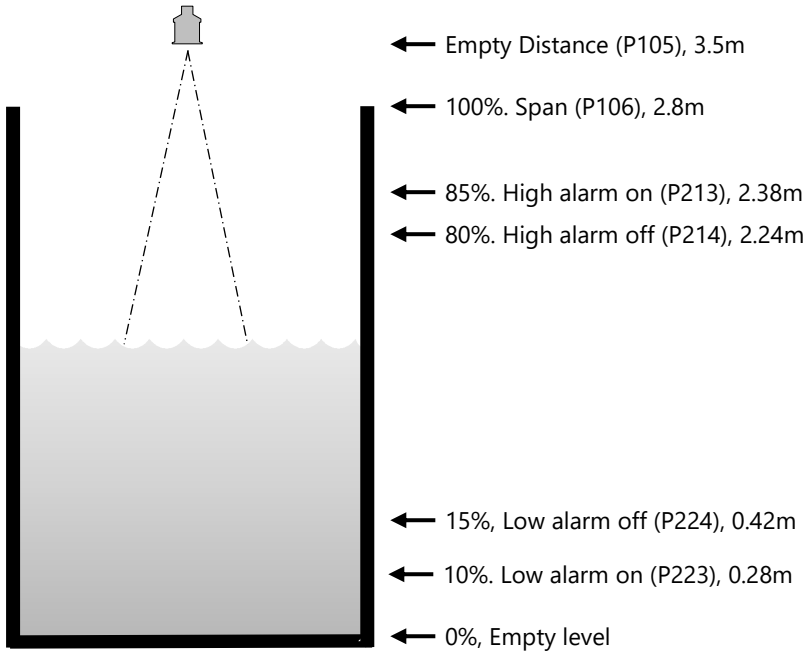

In this example, when the level rises to 2.38 m, relay 1 will come on until the level drops to 2.24 m when it will turn off. If the level drops to 0.28 m, then relay 2 will come on until it rises 0.42 m when it will turn off.

The display will show the level in the tank.

The mA output will be representative of level where 4mA = empty level (0%) and 20mA = 2.8m (100%).

To program the Quantum<sup>2</sup> for **Example 1 Level Monitoring with Alarms** by using the Quick Setup menu proceed as follows. If required to access **Program Mode**, key in the **passcode** 1997 and press **ENTER**

At the **Quick Setup** menu press **ENTER** and as prompted, by the questions, select the relevant option and **ENTER**.

QUESTION	OPTION
Level/Pump/Custom	1 = Level App.
No. of alarms	2 = 2 Alarms
Type alarm 2	2 = Low
Alarm no.2	2 = Set relay 2
Xducer (P101)	2 = dB6
Material (P102)	1 = Liquid
Measurement units (P104)	1 = Metres
Empty Level (P105)	3.5m
Span (P106)	2.8m

Programming is now complete, and the unit can be returned to the run mode, press **CANCEL** until **Run Mode?** Is displayed on the LCD press **ENTER**, and the Quantum<sup>2</sup> will return to the **Run Mode**.

### Important Notice

If relay setpoints do not meet the exact requirements of the application, they can be modified to suit by pressing ENTER when, “For More Options Hit Enter”, is displayed, and entering new values to relay setpoints as required. Alternatively, the relevant relay setpoint can be accessed either by the main menu system or directly via parameter number and changed as necessary.

### Example 2 Sump Control (pump down)

A sump is typically used to temporarily hold water or effluent, and when the level reaches a specific point, the sump is pumped down, with the fluid being transferred to another process.

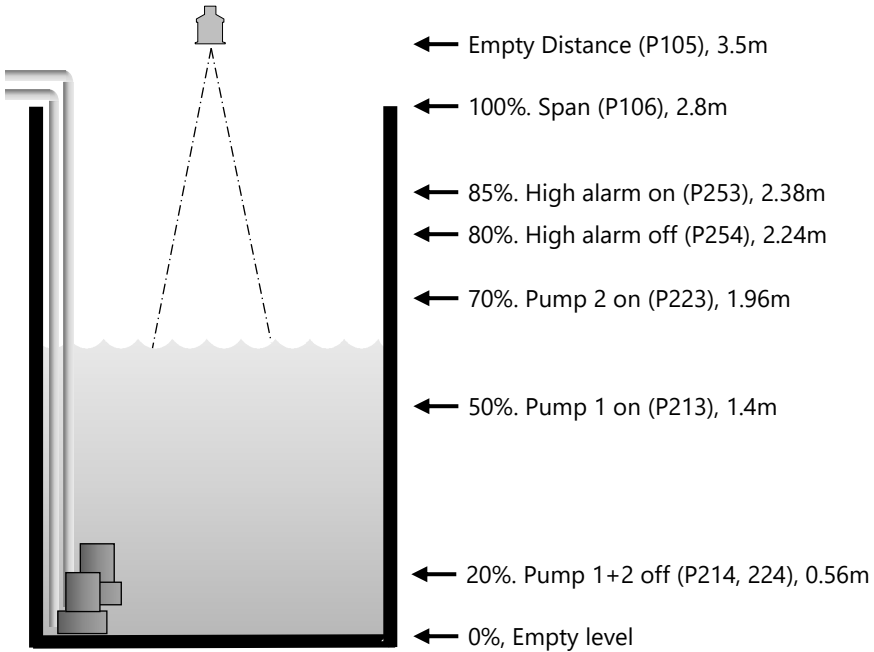

In this example, there are two pumps, which will be set to **alternate duty assist**, so they come on alternately. **Pump 1** is to be set to **Relay 1**, **Pump 2** to **Relay 2**, and the **high-level alarm** to **Relay 5**.

This will operate as follows. During normal operation, **pump 1** will come on at 1.4 m, and pump down to 0.56 m. The setpoints are then shifted to **pump 2**, which will come on first next time.

During peak periods, when **pump 1** cannot cope, **pump 1** will come on at 1.4 m, **pump 2** will come on at 1.96 m, and pump down to 0.56 m. The setpoints are then shifted to **pump 2**, which will come on **first next time**.

If neither pump can cope, and the level rises to 2.38 m, then the **alarm** relay (relay 5) will come on, and go off when the level falls to 2.24 m. This will indicate insufficient capacity of the pumps.

The display will show the level in the sump and the mA output will be representative of level where 4mA = empty level (0%) and 20mA = 2.9m (100%).

To program the Quantum<sup>2</sup> for **Example 2 Sump control (pump down)** by using the **Quick Setup** menu proceed as follows. If required to access **Program Mode**, key in the **passcode** 1997 and press **ENTER**

At the **Quick Setup** menu press **ENTER** and as prompted, by the questions, select the relevant option and **ENTER**.

QUESTION	OPTION
Level/Pump/Custom	2 = Pump Down
No. of Pumps	2 = 2 Pumps
Pump Duty	3 =Alt Duty Assist
Pump No. 1	1 = Set to relay 1
Pump No. 2	2 = Set to relay 2
Type Alarm 1	1 = High Alarm
Alarm No. 1	5 = Set to relay 5
Xducer (P101)	2 = dB6
Measurement units (P104)	1 = Metres
Empty Level (P105)	3.5m
Span (P106)	2.8m

Programming is now complete, and the unit can be returned to the run mode, press **CANCEL** until **Run Mode?** Is displayed on the LCD press **ENTER**, and the Quantum<sup>2</sup> will return to the **Run Mode**.

### Important Notice

If relay setpoints do not meet the exact requirements of the application, they can be modified to suit by pressing ENTER when, “For More Options Hit Enter”, is displayed, and entering new values to relay setpoints as required. Alternatively, the relevant relay setpoint can be accessed either by the main menu system or directly via parameter number and changed as necessary.



## CHAPTER 5 PARAMETER GUIDE

This chapter describes all the parameters in your Quantum<sup>2</sup>, as they appear in the menu system.

### Menu System

Shown below is a set of charts to show you how all the various functions and features can be found using the menu system.

For further details and a full description of all parameters refer to the **Parameter Listings and Descriptions** section of this chapter.

### Top Level Menu

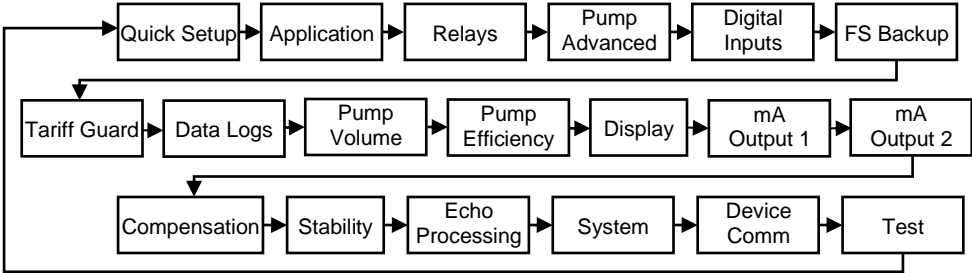

**Application Menu**

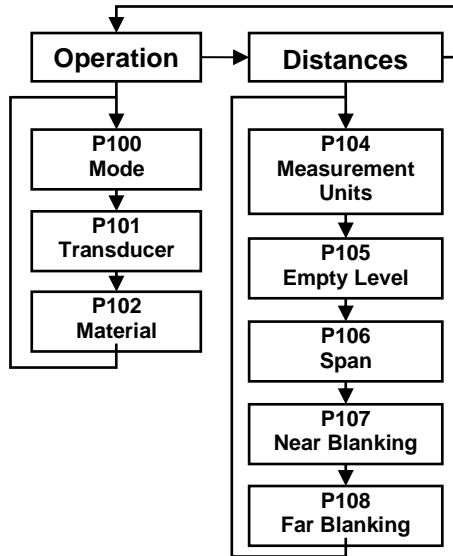

**Relays Menu**

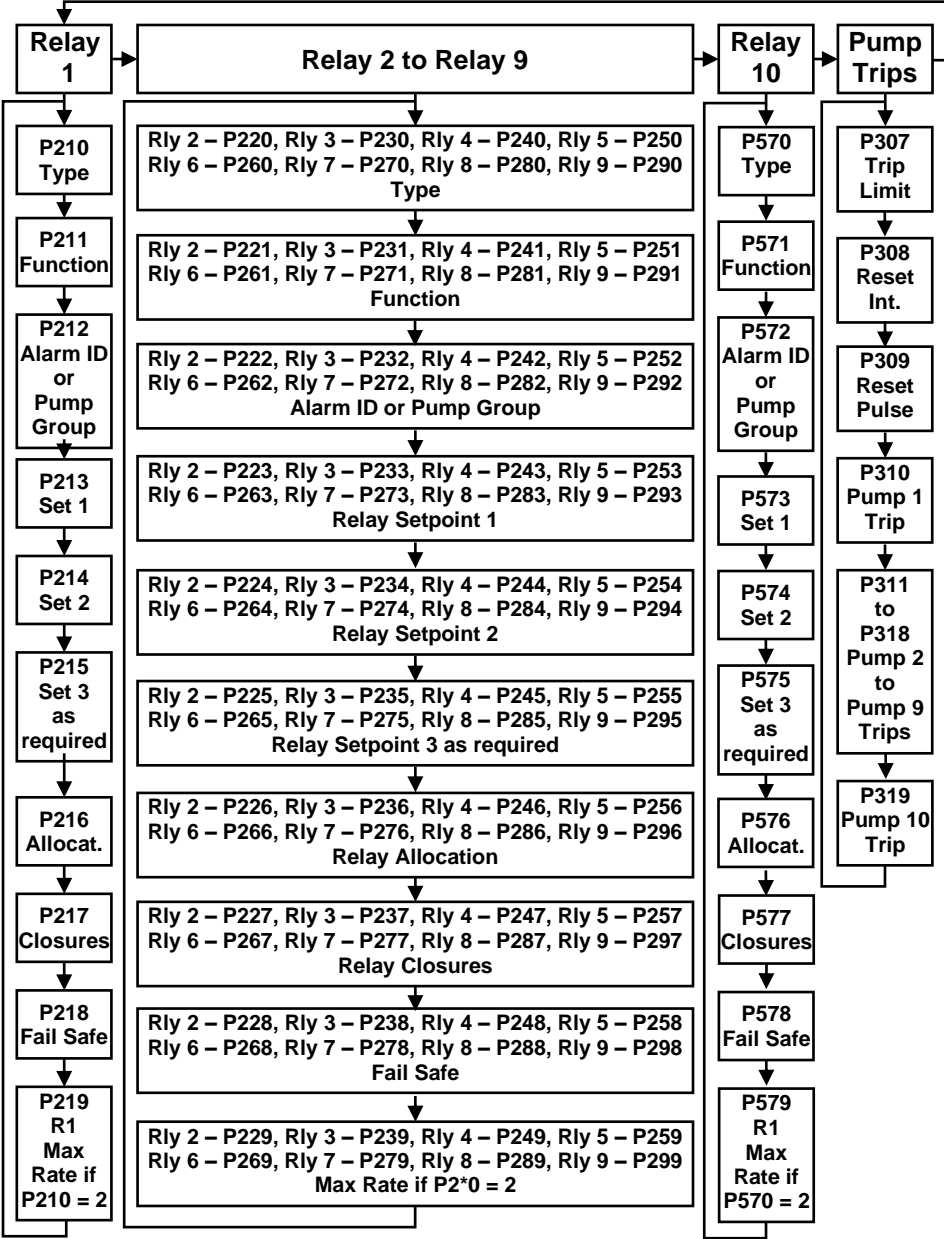

*Pump Advanced Menu*

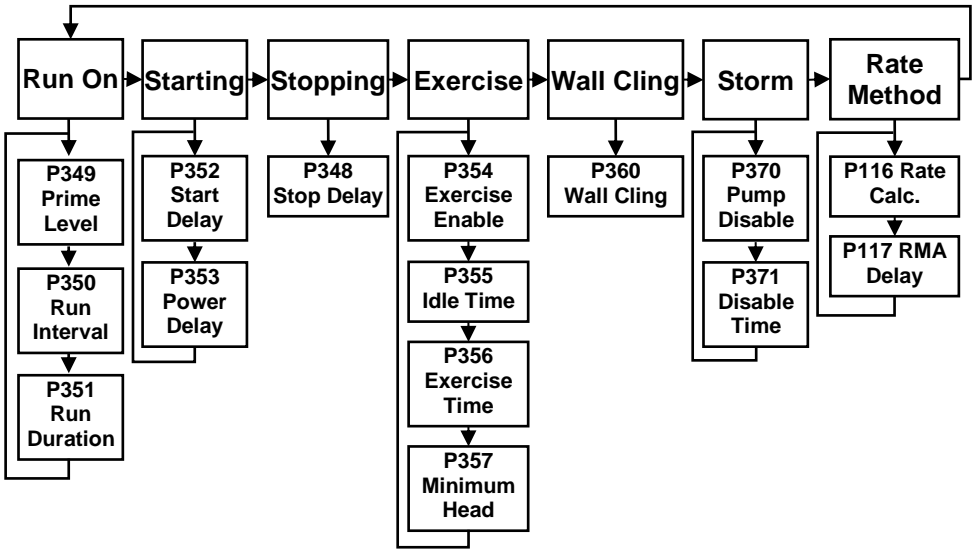

*Digital Inputs Menu*

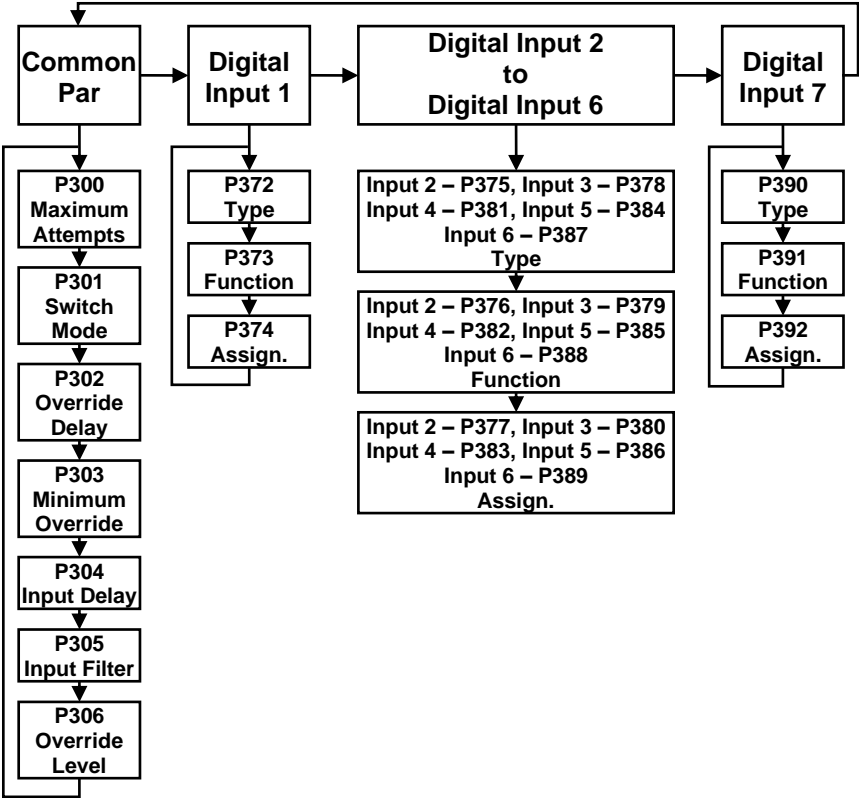

**Float Switch Backup**

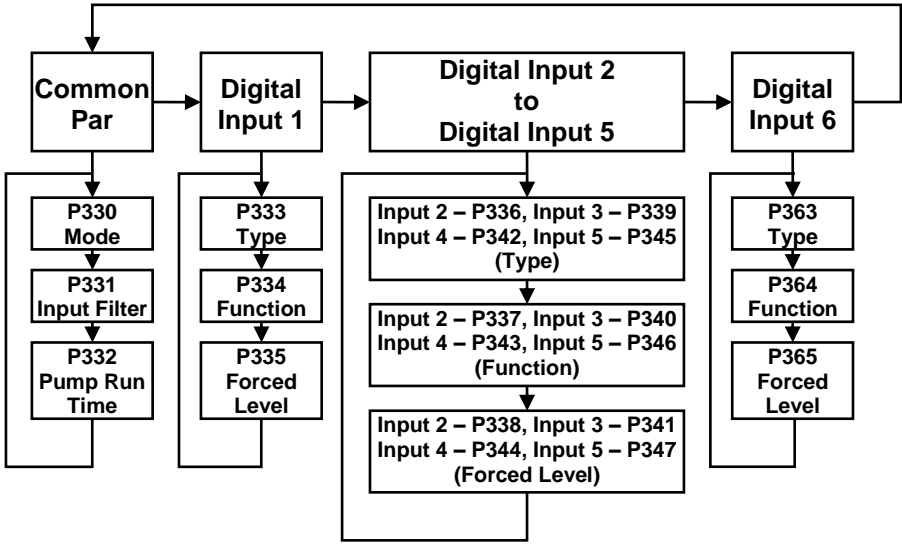

Tariff Guard Menu

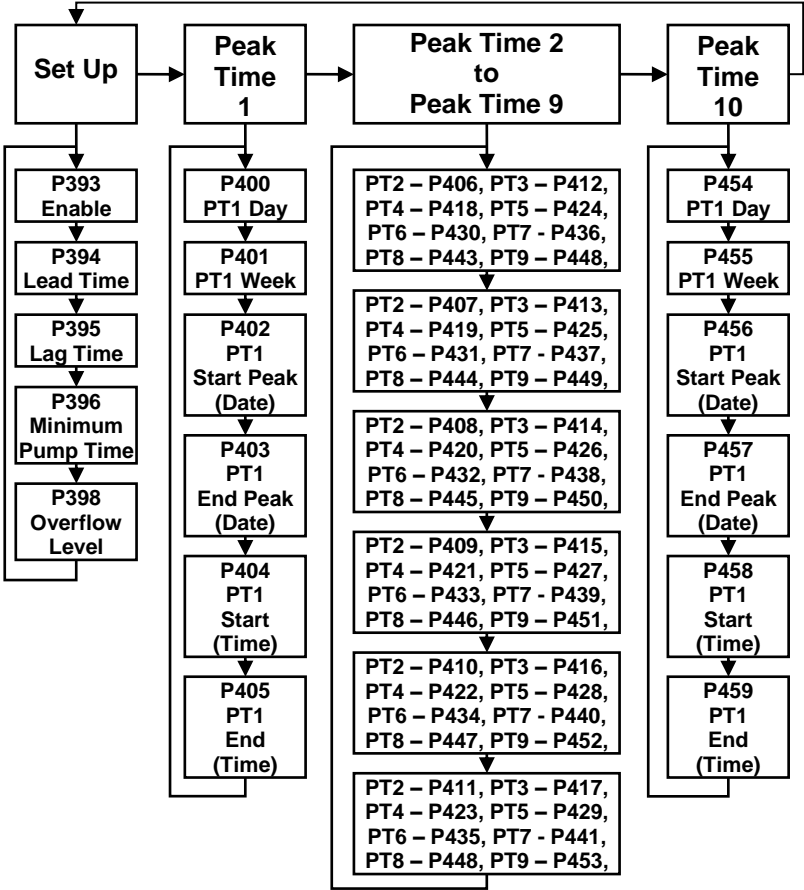

*Data Logs Menu*

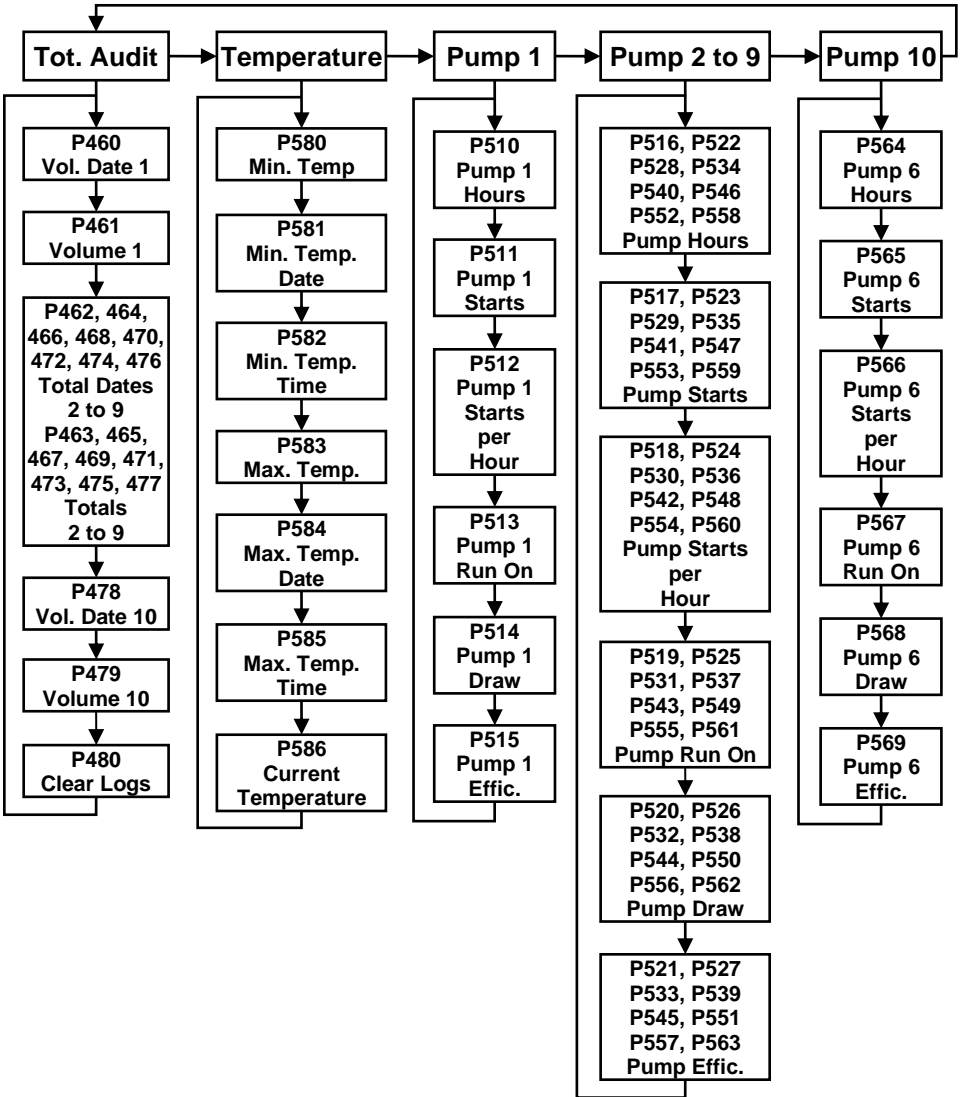



*Pumped Volume Menu*

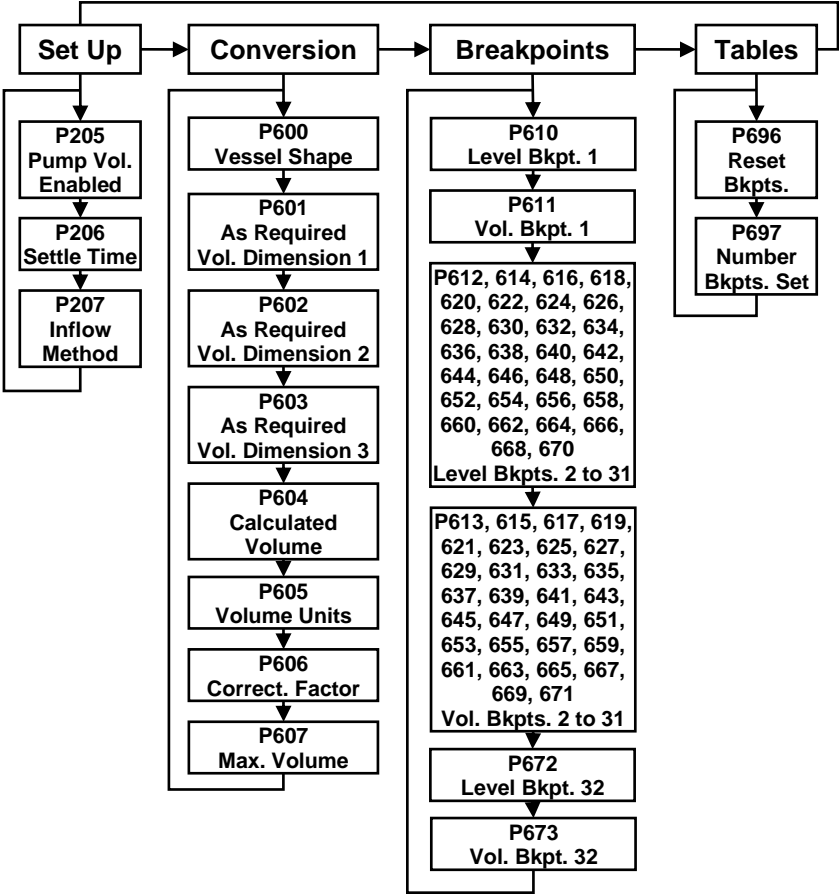

*Efficiency Menu*

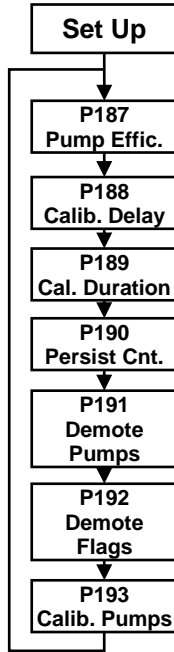

*Display Menu*

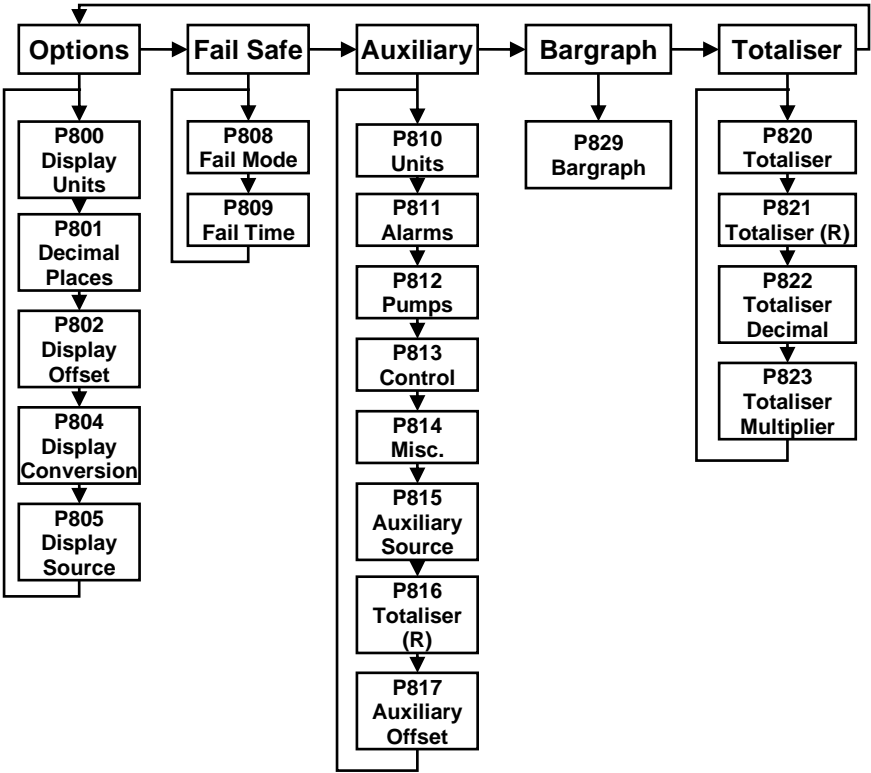

*mA Output 1 Menu*

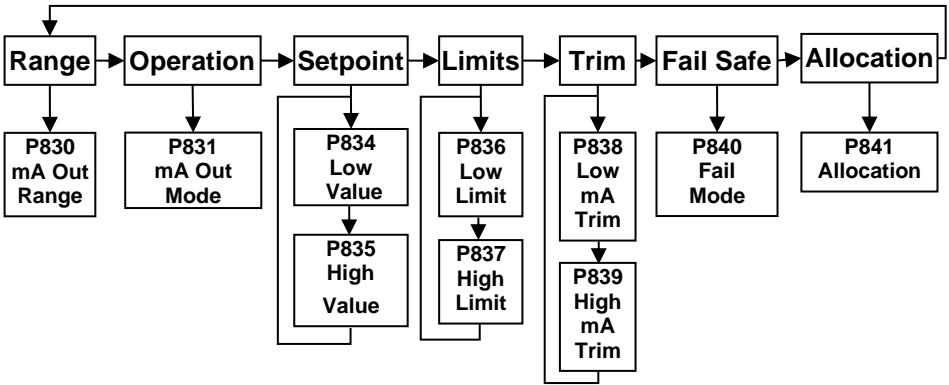

*mA Output 2 Menu*

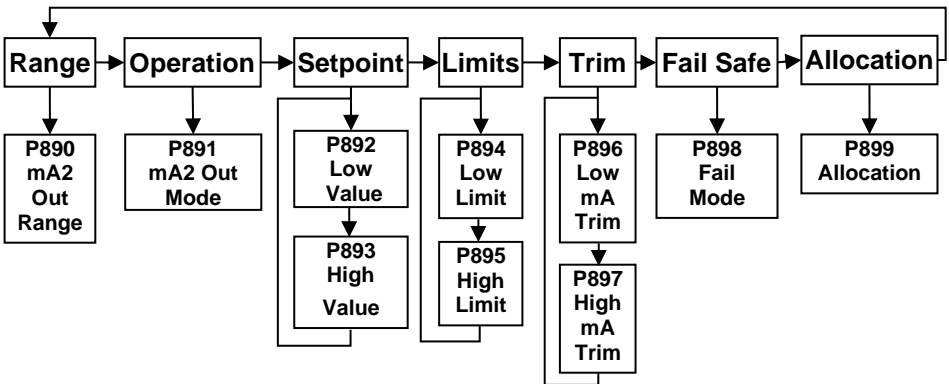

**Compensation**

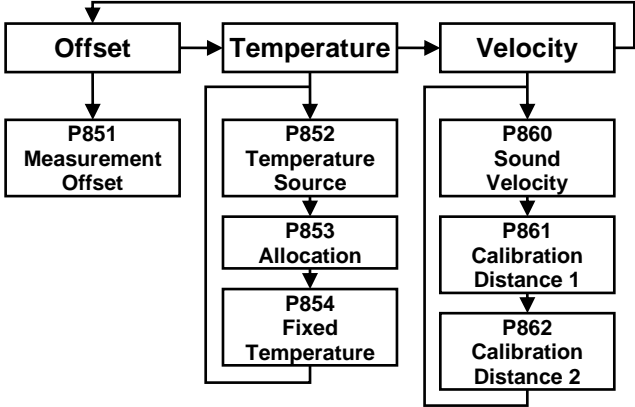

**Stability Menu**

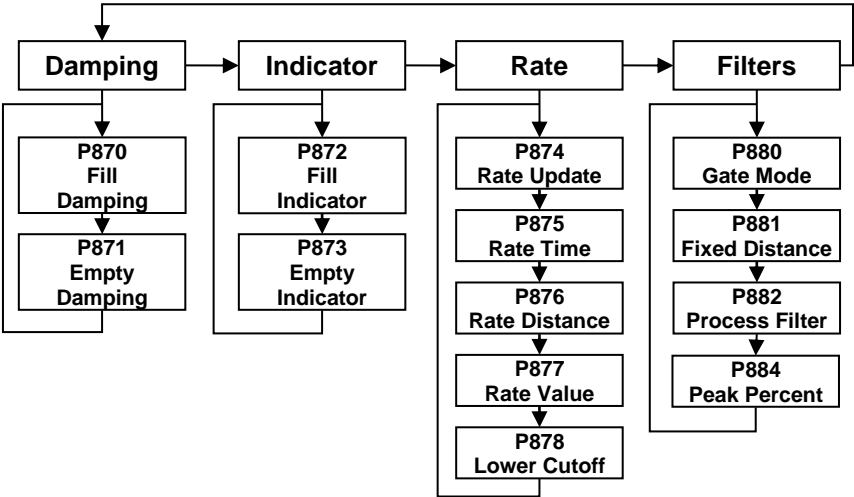

*Echo Processing Menu*

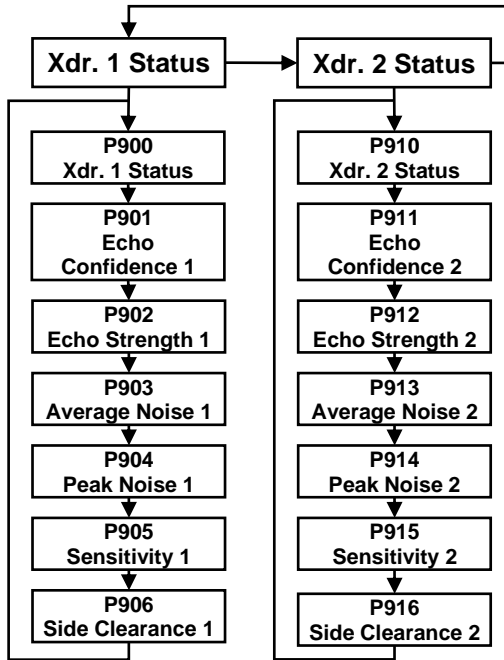

System Menu

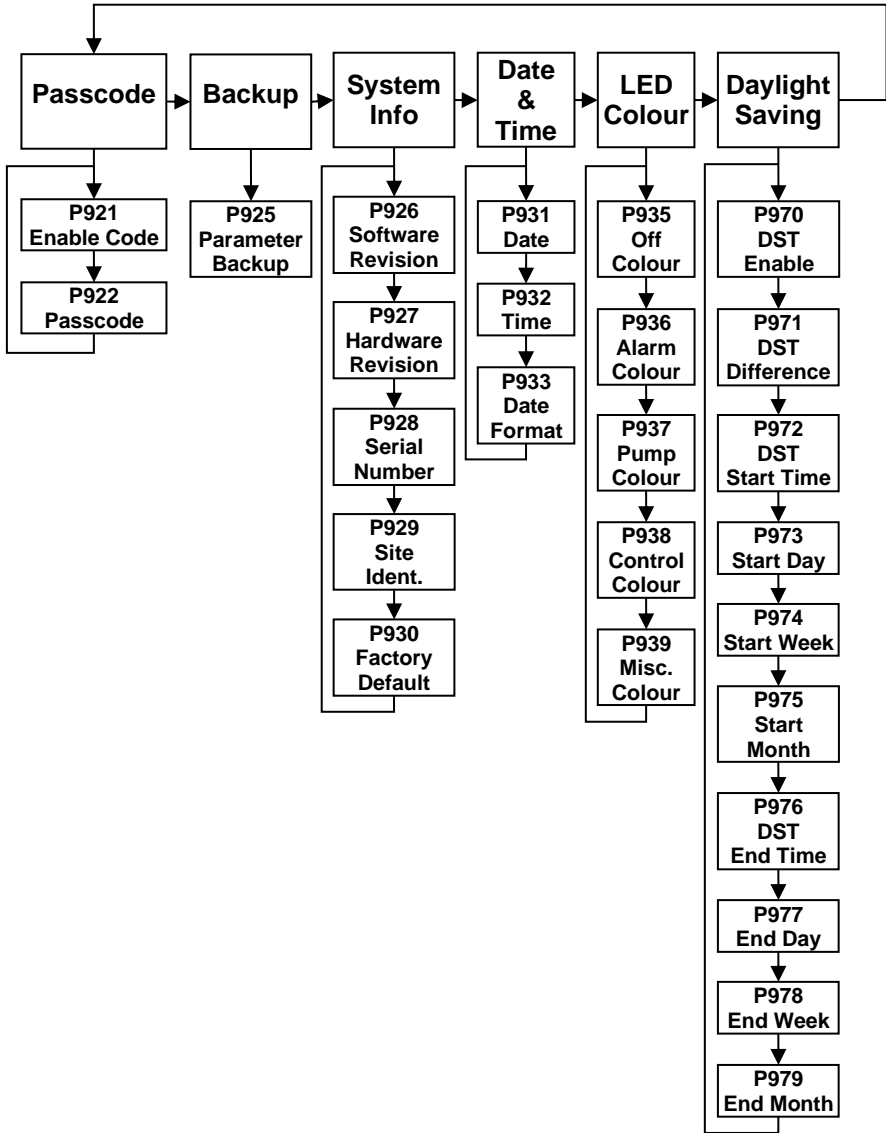

*Device Comm Menu*

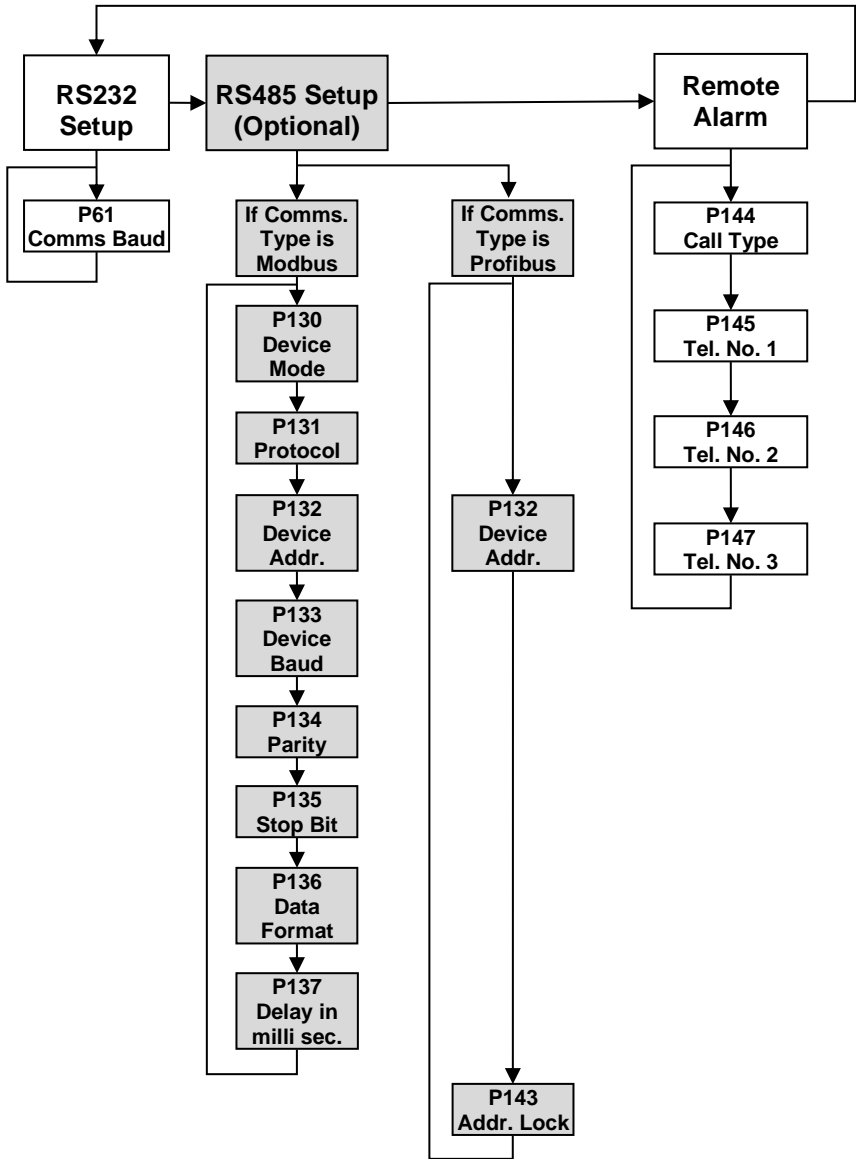



**Test Menu**

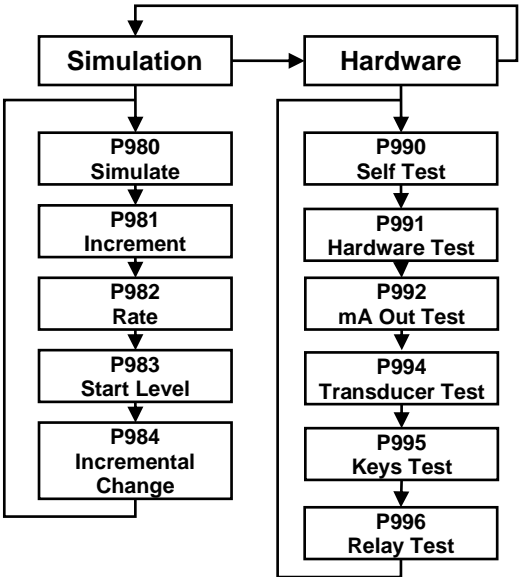

## CHAPTER 6 PARAMETER LISTING AND DESCRIPTION

### Application Parameters

#### Operation

##### *P100 Mode of Operation*

This parameter sets the mode of operation, when in run mode, and can be set to one of the following:

OPTION	DESCRIPTION
<b>1 = Distance (Default)</b>	Display shows the distance from the transducer face to the surface of the material measured.
2 = Level	Shows how full a vessel is.
3 = Space	Shows how empty a vessel is.
4 = Average Level	Display shows the average level of 2 points of measurement
5 = Differential	Display shows the differential level between 2 points of measurement

##### *P101 Xducer (Transducer)*

This parameter should be set to the transducer being used with the unit, and can be set to one of the following:

OPTION	DESCRIPTION
<b>1 = dB3 (Default)</b>	Transducer is a dB3. Range = 0 to 3 metres
2 = dB6	Transducer is a dB6. Range = 0.3 to 6 metres
3 = dB10	Transducer is a dB10. Range = 0.3 to 10 metres
4 = dB15	Transducer is a dB15. Range = 0.5 to 15 metres
5 = dB25	Transducer is a dB25. Range = 0.6 to 25 metres
6 = dB40	Transducer is a dB40. Range = 1.2 to 40 metres
7 = dB56	Transducer is a dB56. Range = 0.2 to 6 metres
8 = dBMach3	Transducer is a dBMach3. Range 0.3 to 1.50 metres
*11 = dBR16	Transducer is a mmWAVE radar. Range = 0.077 to 16 metres
*12 = dBR8	Transducer is a mmWAVE radar. Range = 0.077 to 8 metres

#### Important Notice

\*Please consult your local Pulsar distributor for the versions of firmware that the mmWAVE radars are available in.

### *P102 Material*

This parameter should be set to the type of material being monitored.

OPTION	DESCRIPTION
<b>1 = Liquid (Default)</b>	Used for liquids and flat solid materials.
2 = Solid	Used for sold material that is heaped or at an angle.
3 = Closed Tank	Use for applications within a closed tank or where a secondary echo response may become focused to create a larger echo than the first.

### *Dimensions*

#### *P104 Measurement Units*

This parameter sets the units you want to use for programming and display.

OPTION	DESCRIPTION
<b>1 = metres (Default)</b>	All units of measurement are <b>Metres</b>
2 = cm	All units of measurement are <b>Centimetres</b>
3 = mm	All units of measurement are <b>Millimetres</b>
4 = feet	All units of measurement are <b>Feet</b>
5 = inches	All units of measurement are <b>Inches</b>

### *P105 Empty Level*

This parameter is to be set to the **maximum distance** from the **face** of the transducer to the **empty point**, in **P104 Measurement Units**. Note this value affects span as well, (see the following important information notices), so should be set before span.

#### **Important Notice**

When changing the Empty Distance (P105) you can also recalculate the values for the Span so that it equals the empty distance (P105) minus Near Blanking (P107) and the Relay Setpoints, so that they remain at the same percentage values of the empty distance as they were before you changed the empty distance (P105). You will be asked the question “Recalculate Span?” if you choose yes (enter 1), then the span will be recalculated. Any other answer will leave the span at its original value. You will then be asked if you want to “Recalculate Setpoints?”, if you choose yes (enter 1), then all Relay Setpoints will be recalculated as a percentage of the new empty distance. Any other answer will leave the setpoints at their original values.

**Important Notice**

When using the dB Mach 3 the empty distance is measured from the end of the horn to the empty point in P104 Measurement Units.

*P106 Span*

This parameter should be set to the maximum distance from the **Empty Level (P105)** to the maximum material level. It is automatically set to be equal to the **Empty Level (P105)** less the **Near Blanking distance (P107)** when you set the empty level.

*P107 Span*

This parameter is the distance from the face of the transducer that is not measurable and is pre-set to the minimum value dependant on the **Transducer (P101)** selected. It should not be set to less than this figure, but can be increased, typically to ignore close in obstructions.

TRANSDUCER	NEAR BLANKING DISTANCE
P101 = dB Mach3	Default blanking distance = 0.00 metres
P101 = dB3	Default blanking distance = 0.125 metres
P101 = dB6	Default blanking distance = 0.30 metres
P101 = dB10	Default blanking distance = 0.30 metres
P101 = dB15	Default blanking distance = 0.50 metres
P101 = dB25	Default blanking distance = 0.60 metres
P101 = dB40	Default blanking distance = 1.20 metres
P101 = dB S6	Default blanking distance = 0.20 metres
P101 = dB R16	Default blanking distance = *0.077 metres
P101 = dB R8	Default blanking distance = *0.077 metres

\*The signal emanates from the curved face of the radar, but for the purposes of measurement it is taken from the drip shield.

*P108 Far Blanking Distance*

This is the distance (as a percentage of the **empty level P105**) beyond the empty point that the unit will be able to measure, and by default is pre-set to 20% of the empty level.

If the surface being monitored can be extended beyond the **empty level (P105)** then the far blanking distance can be increased to a max. of 100% of the empty level, provided it does not exceed the max range of the transducer being used. This parameter is always entered as a % of the empty level.

## Relay Parameters

All relay related parameters are prefixed with a **2\*\***.

The second digit of the three-figure parameter number denotes the relay number as follows:

<b>21*</b> parameters for Relay <b>1</b>	<b>22*</b> parameters for Relay <b>2</b>
<b>23*</b> parameters for Relay <b>3</b>	<b>24*</b> parameters for Relay <b>4</b>
<b>25*</b> parameters for Relay <b>5</b>	<b>26*</b> parameters for Relay <b>6</b>
<b>27*</b> parameters for Relay <b>7</b>	<b>28*</b> parameters for Relay <b>8</b>
<b>29*</b> parameters for Relay <b>5</b>	<b>57*</b> parameters for Relay <b>10</b>

The third digit selects specific parameter for the setting of the relays, which can be selected individually and results in the following parameter numbers for each relay:

Relay 1	<b>210</b> to <b>219</b>
Relay 2	<b>220</b> to <b>229</b>
Relay 3	<b>230</b> to <b>239</b>
Relay 4	<b>240</b> to <b>239</b>
Relay 5	<b>250</b> to <b>239</b>
Relay 6	<b>260</b> to <b>269</b>
Relay 7	<b>270</b> to <b>279</b>
Relay 8	<b>280</b> to <b>289</b>
Relay 9	<b>290</b> to <b>299</b>
Relay 10	<b>570</b> to <b>579</b>

*P210, 220, 230, 240, 250 - Relay Type*

This parameter defines what type each relay should be, see the table below for available options:

OPTION	DESCRIPTION
<b>0 = Not in use (Default)</b>	Relay is not in use or programmed and the LED will always be off.
1 = Alarm	Relay is programmed as an alarm relay, which will <b>de-energise ON</b> , and <b>energise OFF</b> . This will ensure an alarm is raised if the power fails to the unit.
2 = Pump	Relay is programmed as a pump relay, which will <b>energise ON</b> , and <b>de-energise OFF</b> .
3 = Control	Relay is programmed as a control relay, which will <b>energise ON</b> , and <b>de-energise OFF</b> .
4 = Miscellaneous	Relay is programmed as a miscellaneous relay, which will <b>energise ON</b> , and <b>de-energise OFF</b> .
5 = Pump by time	Relay is programmed as a pump relay, which will energise at its <b>ON level</b> setpoint, and de-energise at its <b>OFF level</b> setpoint or after a predetermined <b>time</b> period, <b>whichever occurs first</b> .

## Alarms

### P210, 220, 230, 240, 250 = 1 (Alarm)

The **second parameter** for each relay determines the **function** of the alarm.

#### *P211, 221, 231, 241, 251 – Relay Function*

OPTION	DESCRIPTION
<b>0 = Off (Default)</b>	Relay will not operate.
1 = Level	Alarm is based on the level in the vessel, and the type of level alarm (P212, 222, 232, 242, 252) and two setpoints must be set (P2b3, 223, 233, 243, 253 & 214, 224, 234, 244, 254). Setpoints are entered in display units or % of span as referenced to empty level.
2 = Rate of Change	Alarm is based on the rate of change of level in the vessel, and the type of rate of change alarm (212, 222, 232, 242, 252), and two setpoints must be set (213, 223, 233, 243, 253 & 214, 224, 234, 244, 254). Setpoints are entered in Display Units per minute or % of span per minute and a negative value should be entered for a Rate Alarm on a de-creasing level, and a positive value for an increasing level.
3 = Temperature	Alarm is based on the temperature, and the type of temperature alarm (P212, 222, 232, 242, 252) and two setpoints must be set (P213, 223, 233, 243, 253 & P214, 224, 234, 244, 254). The temperature used depends on the temperature source selected (P852). Setpoints are entered in °C.
4 = Loss of Echo	Alarm is raised if the <b>Failsafe Timer (P809)</b> expires. No setpoints are required.
5 = Loss of Clock	Alarm is raised if the expires. No setpoints are required.
6 = Pump Efficiency	When Pump Efficiency is enabled, Alarm is based on the Efficiency of the pump which is allocated to the <b>Relay I.D.</b> (P212, 222, 232, 242, 252, 262, 272, 282, 292, 572) and two setpoints must be set (P213, 223, 233, 243, 253, 263, 273, 283, 293 & P214, 224, 234, 244, 254, 264, 274, 284, 294, 574). Setpoints are entered in %.

OPTION	DESCRIPTION
7 = Device Fail	Alarm is raised if a device, connected to the relay assigned in <b>Alarm ID</b> (P212, 222, 232, 242, 252, 262, 272, 282, 292, 572), fails. E.g. pump is put out of service. No setpoints are required.
8 = Device Alarm	Alarm is raised if a fail signal is detected on the digital input as assigned in <b>Alarm ID</b> (P212, 222, 232, 242, 252, 262, 272, 282, 292, 572) No setpoints are required.
9 = OVF Alarm	Alarm is raised to indicate a <b>“High”</b> level <b>or</b> a potential <b>“Overflow”</b> condition and four setpoints must be set, <b>Overflow Level</b> (P213, 223, 233, 243, 253, 263, 273, 283, 293, 573). <b>Reset Level</b> (P214, 224, 234, 254, 264, 274, 284, 294, 574). <b>High Alarm Level</b> (P215, 225, 235, 245, 255, 265, 275, 285, 295, 575). All level Setpoints are entered in Display Units or % of span as referenced to Empty Level *. <b>Time to Overflow</b> (P219, 229, 239, 249, 259, 269, 279, 289, 579). Setpoint entered in minutes.
10 = RMA Alarm	Alarm is based on the rate of change of level during a pumping cycle, and on the type of RMA alarm (P212, 222, 232, 242, 252, 262, 272, 282, 292, 572) and 3 setpoints must be set. <b>Alarm Setpoint</b> (P213, 223, 233, 243, 253, 263, 273, 283, 293, 573) in rate measurement units. <b>Persistence Time</b> (P214, 224, 234, 254, 264, 274, 284, 294, 574) in seconds. <b>Prime Head Level</b> (P215, 225, 235, 245, 255, 265, 275, 285, 295, 575) in level display units, alarm will not activate below this level.
15 = Tariff Alarm ( <i>Only available in units with firmware version 7.5.1 and above</i> )	Alarm is raised when the unit enters Tariff Guard mode. <b>Tariff Guard enable (P393)</b> must be set to ‘1’ for this option to be selectable. No setpoints are required.

To set figures in %, press the  hot key to show and enter % figure relative to empty level.

### Important Notice

The Loss of Echo, and Loss of Clock will also be shown on the display as “Lost Echo”, and “Lost Clock” respectively.



The third parameter for each relay determines the **Alarm ID** for the relay you wish to set.

*P212, 222, 232, 242, 252 – Relay Alarm ID*

**When P211, 221, 231, 241, 251 =4 (Loss of Echo) or 5 (Loss of Clock)**

This parameter has no function and will not be displayed.

**P211, 221, 231, 241, 251 = 1 (Level), 2 = Rate of Change or 3 (Temp)**

This parameter defines which **alarm type**, or **identification**, the relay should respond to, as follows:

OPTION	DESCRIPTION	SETPOINTS
<b>1 = General (Default)</b>	Relay goes "ON" when the value reaches the ON setpoint and goes "OFF" when the value reaches the OFF setpoint.	P213, 223, 233, 243, 253, 263, 273, 283, 293, 573 is <b>ON</b> Setpoint; P214, 224, 234, 244, 254, 264, 274, 284, 294, 574 is <b>OFF</b> Setpoint
2 = High	Relay goes "ON" when the value rises to the ON setpoint and goes "OFF" when the value lowers to the OFF setpoint.	<b>ON&gt;OFF</b> Relay Setpoints P213, 223, 233, 243, 253, 263, 273, 283, 293, 573 and P214, 224, 234, 244, 254, 264, 274, 284, 294, 574. Setpoints can be set in any order as the unit 'knows' that you are setting a high-level alarm.
3 = HiHi	Same as 2 = High, but different identifier	
4 = Low	Relay goes "ON" when the value lowers to the ON setpoint and goes "OFF" when the value rises to the OFF setpoint.	<b>ON&lt;OFF</b> Relay Setpoints P213, 223, 233, 243, 253, 263, 273, 283, 293, 573 and P214, 224, 234, 244, 254, 264, 274, 284, 294, 574 Setpoints can be set in any order as the unit 'knows' that you are setting a low level alarm.

OPTION	DESCRIPTION	SETPOINTS
5 = LoLo	Same as 4 = Lo, but different identifier	
6 = In bounds	Relay goes "ON" if value is inside the zone between the two setpoints.	Relay Setpoints, P213, 223, 233 and P214, 224, 234 can be set in any order as the unit 'knows' that you are setting an inbounds alarm.
7 = Out of bounds	Relay goes "ON" if value is outside the zone between the two setpoints.	Relay Setpoints P213, 223, 233 and P214, 224, 234 can be set in any order as the unit 'knows' that you are setting an out of bounds alarm.

**When P211, 221, 231, 241, 251, 261, 271, 281, 291, 571 = 4 (Loss of Echo), 5 (Loss of Clock) or 9 = OVF Alarm**

This parameter has no function and will not be displayed.

### When P211, 221, 231, 241, 251, 261, 271, 281, 291, 571 = 6 (Pump Efficiency)

This parameter assigns the **alarm** to the appropriate **pump relay** as detailed below.

OPTION	DESCRIPTION
<b>0 = Off (Default)</b>	Relay will not operate.
1 = Relay 1	Alarm is assigned to <b>pump</b> on <b>Relay 1</b>
2 = Relay 2	Alarm is assigned to <b>pump</b> on <b>Relay 2</b>
3 = Relay 3	Alarm is assigned to <b>pump</b> on <b>Relay 3</b>
4 = Relay 4	Alarm is assigned to <b>pump</b> on <b>Relay 4</b>
5 = Relay 5	Alarm is assigned to <b>pump</b> on <b>Relay 5</b>
6 = Relay 6	Alarm is assigned to <b>pump</b> on <b>Relay 6</b>
7 = Relay 7	Alarm is assigned to <b>pump</b> on <b>Relay 7</b>
8 = Relay 8	Alarm is assigned to <b>pump</b> on <b>Relay 8</b>
9 = Relay 9	Alarm is assigned to <b>pump</b> on <b>Relay 9</b>
10 = Relay 10	Alarm is assigned to <b>pump</b> on <b>Relay 10</b>
11 = All	Alarm is assigned to <b>all relays</b> designated as <b>pump</b>

**When P211, 221, 231, 241, 251, 261, 271, 281, 291, 571 = 7 (Device Fail)**

This parameter defines which **failed device relay**, the **alarm** should respond to, as follows.

OPTION	DESCRIPTION	SETPOINTS
1 = Fail Relay 1 (Default)	Relay goes <b>"ON"</b> when a <b>device failure</b> is detected on <b>relay 1</b> .	None
2 = Fail Relay 2	Relay goes <b>"ON"</b> when a <b>device failure</b> is detected on <b>relay 2</b> .	None
3 = Fail Relay 3	Relay goes <b>"ON"</b> when a <b>device failure</b> is detected on <b>relay 3</b> .	None
4 = Fail Relay 4	Relay goes <b>"ON"</b> when a <b>device failure</b> is detected on <b>relay 4</b> .	None
5 = Fail Relay 5	Relay goes <b>"ON"</b> when a <b>device failure</b> is detected on <b>relay 5</b> .	None
6 = Fail Relay 6	Relay goes <b>"ON"</b> when a <b>device failure</b> is detected on <b>relay 6</b> .	None
7 = Fail Relay 7	Relay goes <b>"ON"</b> when a <b>device failure</b> is detected on <b>relay 7</b> .	None
8 = Fail Relay 8	Relay goes <b>"ON"</b> when a <b>device failure</b> is detected on <b>relay 8</b> .	None
9 = Fail Relay 9	Relay goes <b>"ON"</b> when a <b>device failure</b> is detected on <b>relay 9</b> .	None
10 = Fail Relay 10	Relay goes <b>"ON"</b> when a <b>device failure</b> is detected on <b>relay 10</b> .	None
11 = Any 1 Fail	Relay goes <b>"ON"</b> when a <b>device failure</b> is detected on <b>any 1 relay</b> .	None
12 = Any 2 Fail	Relay goes <b>"ON"</b> when <b>2 device failures</b> are detected on <b>any 2 relays</b>	None

**When P211, 221, 231, 241, 251, 261, 271, 281, 291, 571 = 8 (Device Alarm)**

This parameter defines which **digital input**, the **alarm** should respond to, as follows.

OPTION	DESCRIPTION	SETPOINTS
1 = Fail Input 1 (Default)	Relay goes "ON" when a <b>fail signal</b> is detected on <b>digital input 1</b> .	None
2 = Fail Input 2	Relay goes "ON" when a <b>fail signal</b> is detected on <b>digital input 2</b> .	None
3 = Fail Input 3	Relay goes "ON" when a <b>fail signal</b> is detected on <b>digital input 3</b> .	None
4 = Fail Input 4	Relay goes "ON" when a <b>fail signal</b> is detected on <b>digital input 4</b> .	None
5 = Fail Input 5	Relay goes "ON" when a <b>fail signal</b> is detected on <b>digital input 5</b> .	None
6 = Fail Input 6	Relay goes "ON" when a <b>fail signal</b> is detected on <b>digital input 6</b> .	None
7 = Fail Input 7	Relay goes "ON" when a <b>fail signal</b> is detected on <b>digital input 7</b> .	None

**When P211, 221, 231, 241, 251, 261, 271, 281, 291, 571 = 10 (RMA Alarm).**

This parameter defines which **alarm type**, or **identification**, the relay should respond to, as follows.

ALARM ID	DESCRIPTION	SETPOINTS
<p><b>1 = Blockage (Default)</b></p>	<p>Relay goes "ON" when the pumping rate is lower than the <b>Alarm</b> setpoint for longer than the <b>Persistence Time</b> provided the level is above the <b>Prime Head</b> and goes "OFF" when the pumping rate rises above the <b>Alarm</b> setpoint for longer than the <b>Persistence Time</b>.</p>	<p>P213, 223, 233, 243, 253, 263, 273, 283, 293, 573 is <b>Alarm</b> Setpoint; P214, 224, 234, 244, 254, 264, 274, 284, 294, 574 is <b>Persistence Time</b>; P215, 225, 235, 245, 255, 265, 275, 285, 295, 575 is <b>Prime Head</b>.</p>
<p>2 = Burst</p>	<p>Relay goes "ON" when the pumping rate is above than the <b>Alarm</b> setpoint for longer than the <b>Persistence Time</b> provided the level is above the <b>Prime Head</b> and goes "OFF" when the pumping rate lowers below the <b>Alarm</b> setpoint for longer than the <b>Persistence Time</b></p>	<p>P213, 223, 233, 243, 253, 263, 273, 283, 293, 573 is <b>Alarm</b> Setpoint; P214, 224, 234, 244, 254, 264, 274, 284, 294, 574 is <b>Persistence Time</b>; P215, 225, 235, 245, 255, 265, 275, 285, 295, 575 is <b>Prime Head</b>.</p>

The **fourth parameter** and the **fifth parameter** for each relay set the **Alarm "ON"** and **"OFF"** points. For a **high alarm** the **"ON"** is set **higher than "OFF"**. For **low alarm** then **"ON"** is set **lower than "OFF"**. See the appropriate **alarm ID**, table (P212, 222, 232, 242, 252, 262, 272, 282 292 572) for further information.

**When P211, 221, 231, 241, 251, 261, 271, 281, 291, 571 = 1 (Level), 2 (Rate of Change), 3 (Temp.) or 6 (Efficiency)**

**P213, P223, P233, P243, P253, P263, P273, P283, P293, P573**

*P213, 223, 233, 243, 253, 263, 273, 283, 293, 573 – Relay Setpoint 1*

Determines the **'ON'** or **'OFF'** point for the alarm according to the **ID** selected.

*P214, 224, 234, 244, 254, 264, 274, 284, 294, 574 – Relay Setpoint 2*

Determines the **'ON'** or **'OFF'** point for the alarm according to the **ID** selected.

### Important Notice

**Setpoints** are entered in values according to the **function** selected.

**Level** - entered in Display Units or % of span as referenced to Empty Level.

**Rate of Change** - entered in Display Units per minute or % of span per minute.

For an alarm on an increasing level enter setpoints as a positive value, for an alarm on a decreasing level enter setpoints as a negative value.

**Temperature** - entered in °C.

See the appropriate **alarm function**, table (P211, 221, 231, 241 and 251) for further information.



To set figures in % press the  hotkey to show and enter % figure, relative to empty level.

**When P211, 221, 231, 241, 251, 261, 271, 281, 291, 571 = 4 (Loss of Echo), 5 (Loss of Clock), 7 (Device Fail) or 8 (Device Alarm)**

These parameters have no function and will not be displayed.

**When P211, 221, 231, 241, 251, 261, 271, 281, 291, 571 = 9 (OVF Alarm)**

*P213, P223, P233, P243, P253, P263, P273, P283, P294, P573 - Relay Setpoint 1*

This parameter determines the "**Overflow Level**", this is the level at which an overflow would occur and is the level that the unit will calculate the time to overflow to.

*P214, P224, P234, P244, P254, P264, P274, P284, P294, P574 - Relay Setpoint 2*

This parameter determines the "**Reset Level**", this level determines the point the level has to be below (of fall below) before an activated alarm can be considered to be deactivated, provided the time to overflow does not exceed the "**Time to Overflow**" (P219, 229, 238, 249, 259, 269, 279, 289, 299, 579) and the level is below the "**Reset Level**", the alarm will turn "**OFF**".

*P215, P225, P235, P245, P255, P265, P275, P285, P295, P575 - Relay Setpoint 3*

This parameter determines the level at which the "**High Alarm**" will be activated and should be set below or at the same level as the "**Overflow Level**" (P213, 223, 233, 243, 253, 263, 273, 283, 293, 573).

Relay setpoints 1, 2 and 3 are entered in values of Measurement Units (P104)

*P219, P229, P239, P249, P259, P269, P279, P289, P299, P579 - OVF Time*

This parameter determines the time, prior to a potential overflow occurrence, at which the alarm will activate if it is calculated that an overspill is likely to occur.



**When P211, 221, 231, 241, 251, 261, 271, 281, 291, 571 =10 (RMA Alarm)**

*P213, P223, P233, P243, P253, P263, P273, P283, P294, P573 - Relay Setpoint 1*

This parameter determines the RMA alarm **ON/OFF** point, this is the **rate of change during pumping** at which a potential **burst** or **blockage** condition may occur (depending on Relay Alarm ID). Units are in rate measurement units and are dependent on **P116 Rate Method**.

*P214, P224, P234, P244, P254, P264, P274, P284, P294, P574 - Relay Setpoint 2*

This parameter determines the "**Persistence Time**". This is the amount of time the rate has to **persist** above/below the **Alarm Setpoint** (P213, 223, 233, 243, 253, 263, 273, 283, 293, 573) before the alarm will change state. It is used to prevent relay "chatter" if the rate is near the alarm setpoint. Units are in **Seconds**.

*P215, P225, P235, P245, P255, P265, P275, P285, P295, P575 - Relay Setpoint 3*

This parameter determines the "**Prime Head Level**". The RMA function will not **raise** an alarm below this level but will allow an alarm to turn off. Units are in Measurement Units (P104).

**Pumps**

**P210, 220, 230, 240, 250, 260, 270, 280, 290, 570 = 2 (Pump)**

When a relay is being used for a **pump** function, the **second parameter** determines the **pump duty** that will be used to determine the operating cycle.

*P211, 221, 231, 241, 251, 261, 271, 281, 291, 571 – Relay Function*

This parameter defines which **pump duty** the relay should respond to as follows:

PUMP DUTY	DESCRIPTION
<b>0 = Off (Default)</b>	Relay is always de-energised
1 = Fixed duty assist	All pumps are used to assist each other (run at the same time) and each pump has its own setpoints. (P213, 223, 233, 243, 253, 263, 273, 283, 293, 573 & P214, 224, 234, 244, 254, 264, 274, 284, 294, 574).
2 = Fixed duty backup	If a pump fails to meet the demand (due to malfunction, intake blockage etc.), then it is stopped, and another pump shall take over. Each pump has its own setpoints. (P213, 223, 233, 243, 253, 263, 273, 283, 293, 573 & P214, 224, 234, 244, 254, 264, 274, 284, 294, 574).
3 = Alternate duty assist	All pumps are used to assist each other (run at the same time) and each pump has its own setpoints, (P213, 223, 233, 243, 253, 263, 273, 283, 293, 573 & P214, 224, 234, 244, 254, 264, 274, 284, 294, 574). but each time all pumps have stopped, then the setpoints are sequentially rotated between the pumps to ensure equal pump use.
4 = Alternate duty backup	If a pump fails to meet the demand (due to malfunction, intake blockage etc.), then it is stopped, and another pump shall take over. Each pump has its own setpoints, (P213, 223, 233, 243, 253, 263, 273, 283, 293, 573 & P214, 224, 234, 244, 254, 264, 274, 284, 294, 574). but each time all pumps have stopped, then the setpoints are sequentially rotated between the pumps to ensure equal pump use.

PUMP DUTY	DESCRIPTION
5 = Duty backup and assist	<p>First pump comes on, if it cannot cope, it goes off and next pump comes on (duty backup). This continues until the last pump comes on and if it cannot cope the first pump comes back on to assist the last pump (duty assist) if the level continues to rise all other pumps will come on (assist) in turn until the level decreases to the pump off points. Each pump has its own setpoints, (P213, 223, 233, 243, 253, 263, 273, 283, 293, 573 &amp; P214, 224, 234, 244, 254, 264, 274, 284, 294, 574).</p>
6 = Service ratio duty assist	<p>All pumps are used to assist each other (run at the same time) and each pump has its own setpoints (P213, 223, 233, 243, 253, 263, 273, 283, 293, 573 &amp; P214, 224, 234, 244, 254, 264, 274, 284, 294, 574). And a service ratio setting. The third setpoint (P215, 225, 235, 245, 255, 265, 275, 285, 295, 575) is used to set the service ratio. Each time a pump is required to start then the pump with the least running hours (with respect to the service ratio) is started (i.e. the setpoints are re-assigned accordingly). For example, if two pumps A and B have the service ratio set to 2 and 1 respectively, then pump A will operate for twice as many hours as pump B.</p>

PUMP DUTY	DESCRIPTION
8 = Service ratio duty backup	The first pump switched on is the first pump to be switched off, etc. regardless of the set points, so the setpoints are dynamically changed to enable this. If a pump fails to meet the demand (due to malfunction, intake blockage and so on), then it is stopped and another pump shall take over. Each time a pump is required to start then the pump with the least running hours (with respect to the service ratio) is started (i.e. the setpoints are re-assigned accordingly). Each pump has its own setpoints (P213, 223, 233, 243, 253, 263, 273, 283, 293, 573 & P214, 224, 234, 244, 254, 264, 274, 284, 294, 574). The third setpoint (P215, 225, 235, 245, 255, 265, 275, 285, 295, 575) is used to set the service ratio. For example, if two pumps A and B have the service ratio set to 2 and 1 respectively, then pump A will operate for twice as many hours as pump B.
8 = <b>First On First Off</b> Alternate duty assist	The first pump switched on is the first pump to be switched off, etc. regardless of the set points, so the setpoints are dynamically changed to enable this.
9 = Service Ratio Standby	When a service ratio duty is being used, on all other pumps in use, the standby pump can be started on a ratio basis only, when it will assume the setpoints of the next pump to start. The third setpoint (P215, 225, 235, 245, 255, 265, 275, 285, 295, 575) is used to set the service ratio.
10 = Two Pump Sets	There are four pumps. Two rotate their start-up sequence with each other. If the two pumps cannot keep up, the level rise to the setpoints of the other two pumps which take over and rotate their sequence with each other.

### Important Notice

The pumps are started and stopped at the “ON” and “OFF” setpoints. To *pump down* (reduce level) then set “ON” higher than “OFF”. To *pump up* (increase level) then set “ON” lower than “OFF”.

The **third parameter** for each relay determines the pump group. You can have two groups of pumps, and all similar duties within that group will operate together.

*P212, 222, 232, 242, 252, 262, 272, 282, 292, 572 – Relay Pump Group*

By **default**, all pump groups are set to **1**, but if you want to have another group, then set this parameter to 2, for each pump relay that should operate together as part of a second group.

The **fourth parameter** and the **fifth parameter** for each relay set the **pump “ON”** and **“OFF”** points, which are entered in **Measurement units P104**. For *pump down* the “ON” is set **higher than “OFF”**. For *pump up* then “ON” is set **lower than “OFF”**. See the appropriate **pump duty**, function table (**P212, 222, 232, 242, 252**) for further information.

*P213, 223, 233, 243, 253, 263, 273, 283, 293, 573 – Relay Setpoint 1*

This parameter determines the ‘**ON**’ point of the pump.

*P214, 224, 234, 244, 254, 264, 274, 284, 294, 574 – Relay Setpoint 2*

This parameter determines the ‘**OFF**’ point of the pump.

The **sixth parameter** will determine the **service ratio** that will be used to switch the pump, when **pump duty** selected is a Service Ratio duty.

*P215, 225, 235, 245, 255, 265, 275, 285, 295, 575 – Relay Setpoint 3*

This parameter determines the Service Ratio in values of %. See the appropriate **pump duty** function, table (**P211, 221, 231, 241, 251, 261, 271, 281, 291, 571**), for further information.

*P219, 229, 239, 249, 259, 269, 279, 289, 299, 579 – Relay Max Rate*

This parameter will allow a **pump** to be **switched** at a pre-determined **Rate of change of Level**, irrespective of the “ON” level setpoint P213, 223, 233, 243, 253. Once a pump relay has been switched “ON” by the pre-determined **Rate of Change**, it will remain energised until the level reaches the “OFF” level setpoint **P214, 224, 234, 244, 254, 264, 274, 284, 294, 574**.

Max. Rate is entered in Measurement Units (P104) per minute and can be entered as either positive (increasing level) or negative (decreasing level) values.

**Control**

**When P210, 220, 230, 240, 250, 260, 270, 280, 290, 570 = 3 (Control)**

When a relay is being set up as a **control** relay, the **second parameter** that will be displayed in the menu determines its **function**.

*P211, P221, P231, P241, P251, P261, P271, P281, P291, P571 - Relay Function*

This function allows the relay to be assigned to specific **control** functions (other than pumps and alarms) several of these functions work in relation to time.

This can be used to activate devices based on elapsed time or running cycles, such as a timed rake control to keep a ram lubricated if idle for long periods, or flush valve operation.

OPTIONS	DESCRIPTION
<b>0 = Off (Default)</b>	Relay is always de-energised
1 = Time	Relay will <b>energise “ON”</b> after the <b>Cycle time</b> that is set in Relay <b>Setpoint 2</b> (P214, 224, 234, 244, 254, 264, 274, 284, 294, 574). And turns “OFF”, <b>de-energises</b> , after the <b>On Time Period</b> that is set in Relay <b>Setpoint 1</b> (P213, 223, 233, 243, 253, 263, 273, 283, 293, 573)
2 = Storm	Relay will <b>energise “ON”</b> when storm conditions are in effect and, <b>de-energise “OFF”</b> when storm conditions cease. Two setpoints are required, Upper Storm “ON”, (P213, 223, 233, 243, 253, 263, 273, 283, 293, 573) and Lower Storm, “OFF” (P214, 224, 234, 244, 254, 264, 274, 284, 294, 574). This allows the relay to be used to activate a device as a result of high levels such as a storm condition e.g. opening a gate valve to divert storm overflow into a holding vessel.

OPTIONS	DESCRIPTION
3 = Aeration	<p>Relay will <b>energise "ON"</b> after each <b>Cycle time</b> as set in Relay <b>Setpoint 2</b> (P214, 224, 234, 244, 254, 264, 274, 284, 294, 574). And turns <b>"OFF"</b>, <b>de-energises</b>, after the set <b>On Time Period</b> as set in Relay <b>Setpoint 1</b> (P213, 223, 233, 243, 253, 263, 273, 283, 293, 573). This can be used to activate a device based upon elapsed time since <b>All Pumps</b> have been <b>"OFF"</b>, such as the introduction of fresh air to reduce gas concentration.</p>
4 = Flush Valve	<p>Relay will <b>energise "ON"</b> when Flush condition is in effect and goes off when Flush condition is cleared. A relay being used for Flush Valve/Pump must be assigned to one of the main pumps in use. Flush relay <b>Alarm ID</b> (P212, 222, 232, 242, 252, 262, 272, 282, 292, 572) is used to enter the <b>relay number</b>, to which <b>the assigned pump is connected</b>.</p> <p>Flush Valve/Pump relay requires three setpoints. The first set point (P213, 223, 233, 243, 253, 263, 273, 283, 293, 573) determines the <b>Flush Interval</b>, which is the number of main <b>pump cycles</b> that should occur before the Flush Valve/Pump operates. The second setpoint (P214, 224, 234, 244, 254, 264, 274, 284, 294, 574), sets the number of <b>Flush cycles</b> the Flush Valve/Pump will operate for. This means that the Flush Valve will be operated for a number of main pump starts (<b>Flush Cycles</b>) after which the Flush Valve activity will cease until the <b>Flush Interval</b> comes around again. Setpoint three of the Flush Valve/Pump relay sets the <b>Flush Duration</b>, (P215, 225, 235, 245, 255, 265, 275, 285, 295, 575) this is the duration for Flush Cycle, in seconds.</p>

OPTIONS	DESCRIPTION
5 = Step Time	<p>Step Time Control allows relays to be used to control a device, such as a motorised valve or gate, in order to maintain the level within two predetermined points. Relays will <b>energise "ON"</b> when Step Time condition is in effect and <b>de-energises "OFF"</b> when Step Time goes off. One relay will be required to control an increase in level, ('open' the device) and a second relay is required to control a decrease in level, ('close' the device). <b>Alarm ID</b> (P212, 222, 232, 242, 252, 262, 272, 282, 292, 572) is used to assign the relay to control either the <b>open</b> or <b>close</b> condition. Step Time Control relay requires three setpoints. The first set point (P213, 223, 233, 243, 253, 263, 273, 283, 293, 573) determines the <b>level</b>, at which the relay is to be activated, (N.B. level setpoint for <b>open</b> relay, <b>increase</b> the level, must be <b>lower than</b> the setpoint for the <b>close</b> relay, <b>decrease</b> the level). The relay will <b>energise "ON"</b> after the <b>Limit time</b> that is set in Relay <b>Setpoint 3</b> (P215, 225, 235, 245, 255, 265, 275, 285, 295, 575). And turns <b>"OFF", de-energises</b>, after the <b>Drive Period</b> that is set in Relay <b>Setpoint 2</b> (P214, 224, 234, 244, 254, 264, 274, 284, 294, 574).</p>
6 = Differential Control	<p>Relay will <b>energise "ON"</b> when a differential condition is in effect and, <b>de-energise "OFF"</b> when the differential conditions cease. Two setpoints are required, <b>Differential</b> control <b>"ON"</b>, (P213, 223, 233, 243, 253, 263, 273, 283, 293, 573) and <b>Differential</b> control, <b>"OFF"</b> (P214, 224, 234, 244, 254, 264, 274, 284, 294, 574). This allows the relay to be used to activate a device as a result of a differential level, between two points e.g. operate a rake on a screen.</p>
7 = Pump Reset	<p>Relay will <b>energise "ON"</b> for the period of the <b>Reset Pulse</b> (P309) after expiry of the <b>Reset Interval</b> (P308), provided the level is above the <b>Prime Level</b> (P349), to reset the designated pump that has tripped. <b>Alarm ID</b> (P212, 222, 232, 242, 252, 262, 272, 282, 292, 572) is used to enter the <b>relay number</b>, to which the <b>designated pump</b> is connected.</p>



The **third parameter** for each relay determines the **assignment** or **condition** of the relay, where required.

*P212, 222, 232, 242, 252, 262, 272, 282, 292, 572 – Relay Alarm ID/Pump Group*

**P211, 221, 231, 241, 251, 261, 271, 281, 291, 571 = 1, 2, 3 or 6**

This parameter has no function and will not be displayed.

**P211, 221, 231, 241, 251, 261, 271, 281, 291, 571 = 4 (Flush Valve)**

If the relay is selected for Flush Valve/Pump, then this parameter is used to determine to which pump the Flush function is assigned. Enter the **relay number to which the assigned pump is connected**.

**P211, 221, 231, 241, 251, 261, 271, 281, 291, 571 = 5 (Step Time)**

If the relay is selected for Step Time, then this parameter is used to assign the relay to the 0 = **Open** condition (increase level) or 1 = **Close** condition (decrease level).

**P211, 221, 231, 241, 251, 261, 271, 281, 291, 571 = 7 (Reset)**

If the relay is selected for Reset, then this parameter is used to determine to which pump the Reset function is assigned. Enter the **relay number to which the assigned pump is connected**.

The **fourth parameter**, **fifth parameter** and **sixth parameter** are set to determine the switch points, "**ON**" and "**OFF**" for the relay and where required the order of start. See **control function**, table (**P211, 221, 231, 241, 251, 261, 271, 281, 291, 571**) for further information.

**P213, P223, P233, P243, P253, P263, P273, P283, P293, P573**

*Relay Setpoint 1*

**P213, 223, 233, 243, 253, 263, 273, 283, 293, 573 =1 (Time)**

This parameter determines the "**Time Period**" that the relay will remain "**ON**". Relay Setpoints are entered in Minutes.

See the appropriate relay **Function** tables (**P211, 221, 231, 241, 251, 261, 271, 281, 291, 571**) for further information.

**P213, 223, 233, 243, 253, 263, 273, 283, 293, 573 = 2 (Storm)**

Relay Setpoint 1 is entered in values of **Measurement Units (P104)**. See the appropriate relay function tables (**P211, 221, 231, 241, 251, 261, 271, 281, 291, 571**) for further information.

**P213, 223, 233, 243, 253, 263, 273, 283, 293, 573 = 3 (Aeration)**

Relay Setpoint 1 is entered in Minutes to set **Cycle Time**. See the appropriate relay **Function** tables (**P211, 221, 231, 241, 251, 261, 271, 281, 291, 571**) for further information.

**P213, 223, 233, 243, 253, 263, 273, 283, 293, 573 = 4 (Flush Valve).**

Relay Setpoint 1 is entered in Pump cycles to set **Flush Interval**. See the appropriate relay **Function** tables (**P211, 221, 231, 241, 251, 261, 271, 281, 291, 571**) for further information.

**P213, 223, 233, 243, 253, 263, 273, 283, 293, 573 =5 (Step Time)**

Relay Setpoint 1 is entered in values of **Measurement Units (P104)**. See the appropriate relay function tables (**P211, 221, 231, 241, 251, 261, 271, 281, 291, 571**) for further information.

**P213, 223, 233, 243, 253, 263, 273, 283, 293, 573 =6 (Differential)**

Relay Setpoint 1 is entered in values of **Measurement Units (P104)**. See the appropriate relay function tables (**P211, 221, 231, 241, 251, 261, 271, 281, 291, 571**) for further information.

**P213, 223, 233, 243, 253, 263, 273, 283, 293, 573 = 7 (Reset)**

This parameter has no function and will not be displayed.

*Relay Setpoint 2*

**P214, 224, 234, 244, 254, 264, 274, 284, 294, 574 = 1 (Time)**

This parameter determines the "Cycle Time " for the operation of the relay. See the appropriate relay Function tables (**P211, 221, 231, 241, 251, 261, 271, 281, 291, 571**) for further information.

**P214, 224, 234, 244, 254, 264, 274, 284, 294, 574 = 2 (Storm)**

Relay Setpoints are entered in values of Measurement Units (P104). See the appropriate relay Function tables (**P211, 221, 231, 241, 251, 261, 271, 281, 291, 571**) for further information.

**P214, 224, 234, 244, 254, 264, 274, 284, 294, 574 = 3 (Aeration)**

Relay Setpoints are entered in Minutes to set Time Period that the relay will remain ON. See the appropriate relay Function tables (**P211, 221, 231, 241, 251, 261, 271, 281, 291, 571**) for further information.

**P214, 224, 234, 244, 254, 264, 274, 284, 294, 574 = 4 (Flush Valve)**

Relay Setpoints are entered in cycles to set the number of Flush cycles.

See the appropriate relay Function tables (**P211, 221, 231, 241, 251, 261, 271, 281, 291, 571**) for further information.

**P214, 224, 234, 244, 254, 264, 274, 284, 294, 574 = 5 (Step Time)**

Relay Setpoints are entered in Seconds to set Drive Period, the time that the relay will remain ON. See the appropriate relay Function tables (**P211, 221, 231, 241, 251, 261, 271, 281, 291, 571**) for further information.

**P214, 224, 234, 244, 254, 264, 274, 284, 294, 574 = 6 (Differential)**

Relay Setpoints are entered in values of Measurement Units (P104). See the appropriate relay Function tables (**P211, 221, 231, 241, 251, 261, 271, 281, 291, 571**) for further information.

**P214, 224, 234, 244, 254, 264, 274, 284, 294, 574 = 7 (Reset)**

This parameter has no function and will not be displayed.

**P215, P225, P235, P245, P255, P265, P275, P285, P295, P575**

*Relay Setpoint 3*

**P211, 221, 231, 241, 251, 261, 271, 281, 291, 571 = 1, 2, 3, 6 or 7**

This parameter has no function and will not be displayed.

**P215, 225, 235, 245, 255, 265, 275, 285, 295, 575 = 4 (Flush Valve)**

Enter desired Flush duration in seconds. See the appropriate relay Function tables (**P211, 221, 231, 241, 251, 261, 271, 281, 291, 571**) for further information.

**P215, 225, 235, 245, 255, 265, 275, 285, 295, 575 = 5 (Step Time)**

This parameter is used to determine the Limit Time between each Drive Period. Relay Setpoints are entered in Minutes, during which time the relay will remain OFF.

See the appropriate relay Function tables (**P211, 221, 231, 241, 251, 261, 271, 281, 291, 571**) for further information.

**Miscellaneous**

**P210, 220, 230, 240, 250, 260, 270, 280, 290, 570 = 4 (Miscellaneous)**

When a relay is set to be a **miscellaneous relay**, the **second parameter** determines its **function**.

*P211, 221, 231, 241, 251, 261, 271, 281, 291, 571 – Relay Function*

This function allows the relay to work in relation to a clock or a specific event and will be set to activate in relation to Real Time.

OPTIONS	DESCRIPTION
<b>0 = Off (Default)</b>	Relay is always de-energised
1 = Clock	Relay will <b>energise ON</b> at a specified time each day as set in Relay Setpoint 1 (P213, 223, 233, 243, 253, 263, 273, 283, 293, 573). And turns <b>OFF, de-energises</b> , after the specified On Time period as set in Relay Setpoint 2 (P214, 224, 234, 244, 254, 264, 274, 284, 294, 574)
2 = Totaliser	Relay will energise ON momentarily each time the specified flow has passed as set in Relay setpoint 1 (P213, 223, 233, 243, 253, 263, 273, 283, 293, 573), this parameter sets the multiplication factor which will be applied to the on board totaliser (P820) to determine the switch point of the relay. E.g. if the totaliser is set to totalise in cubic metres and the relay is required to provide a closure every 10,000 litres Relay setpoint 1 would be set to 10. Relay setpoint 2 (P214, 224, 234, 244, 254, 264, 274, 284, 294, 574) can be used to select the time the relay will remain closed in seconds.

**Important Notice**

When using a Relay to control a device at a specified time of day ensure that the Time P932 is set correctly. And if required, enable Daylight Saving for the appropriate time difference P970 – P979.

The **third parameter** has **no function** when **miscellaneous relay** is chosen and will not be displayed.

The **fourth parameter**, and **fifth parameter**, are set to determine the switch points, "ON" and "OFF" for the relay. See **miscellaneous** function table (**P211, 221, 231, 241, 251, 261, 271, 281, 291, 571**) for further information.

**P210, 220, 230, 240, 250 = 1 (Clock)**

*P213, 223, 233, 243, 253, 263, 273, 283, 293, 573 – Relay Setpoint 1*

Relay Setpoints are entered in Hours & Minutes (HH:MM) to set Time at which relay will energise. Default = **00:00 (HH:MM)**

*P214, 224, 234, 244, 254, 264, 274, 284, 294, 574 – Relay Setpoint 2*

Relay Setpoints are entered in seconds to set the time period that the relay will remain 'ON'. **Default = 0.00 mins.**

**P210, 220, 230, 240, 250, 260, 270, 280, 290, 570 = 2 (Totaliser)**

*P213, 223, 233, 243, 253, 263, 273, 283, 293, 573 – Relay Setpoint 1*

Relay Setpoints are entered as a factor by which the on board totaliser (P820) should be multiplied by to provide a relay closure. **Default = 0.00**

*P214, 224, 234, 244, 254, 264, 274, 284, 294, 574 – Relay Setpoint 2*

Relay Setpoints are entered in seconds to set the time period that the relay will remain 'ON'. **Default = 0.00 secs.**

**Pump by Time**

When a relay is assigned to Pump by Time the pump will come on (energise) at its normal “**ON**” level setpoint, and de-energise at its **OFF level** setpoint or after a predetermined **time** period, **whichever occurs first**.

**P210, 220, 230, 240, 250, 260, 270, 280, 290, 570 = 5 (Pump by Time)**

When a relay is being used for a **pump by time** function, the **second parameter** determines the **pump duty** that will be used to determine the operating cycle.

*P211, P221, P231, P241, P251, P261, P271, P281, P291, P571 - Relay Function*

This parameter defines which **pump duty** the relay should respond to as follows.

PUMP DUTY	DESCRIPTION
<b>0 = Off (Default)</b>	Relay is always de-energised
1 = Fixed duty assist	All pumps are used to assist each other (run at the same time) and each pump has its own setpoints. (P213, 223, 233, 243, 253, 263, 273, 283, 293, 573 & P214, 224, 234, 244, 254, 264, 274, 284, 294, 574).
2 = Fixed duty backup	If a pump fails to meet the demand (due to malfunction, intake blockage etc.), then it is stopped, and another pump shall take over. Each pump has its own setpoints. (P213, 223, 233, 243, 253, 263, 273, 283, 293, 573 & P214, 224, 234, 244, 254, 264, 274, 284, 294, 574).
3 = Alternate duty assist	All pumps are used to assist each other (run at the same time) and each pump has its own setpoints, (P213, 223, 233, 243, 253, 263, 273, 283, 293, 573 & P214, 224, 234, 244, 254, 264, 274, 284, 294, 574). but each time all pumps have stopped, then the setpoints are sequentially rotated between the pumps to ensure equal pump use.

PUMP DUTY	DESCRIPTION
4 = Alternate duty backup	If a pump fails to meet the demand (due to malfunction, intake blockage etc.), then it is stopped, and another pump shall take over. Each pump has its own setpoints, (P213, 223, 233, 243, 253, 263, 273, 283, 293, 573 & P214, 224, 234, 244, 254, 264, 274, 284, 294, 574). but each time all pumps have stopped, then the setpoints are sequentially rotated between the pumps to ensure equal pump use.
5 = Duty backup and assist	First pump comes on, if it cannot cope, it goes off and next pump comes on (duty backup). This continues until the last pump comes on and if it cannot cope the first pump comes back on to assist the last pump (duty assist) if the level continues to rise all other pumps will come on (assist) in turn until the level decreases to the pump off points. Each pump has its own setpoints, (P213, 223, 233, 243, 253, 263, 273, 283, 293, 573 & P214, 224, 234, 244, 254, 264, 274, 284, 294, 574).

### Important Notice

The pumps are started and stopped at the “ON” and “OFF” setpoints. To *pump down* (reduce level) then set “ON” higher than “OFF”. To *pump up* (increase level) then set “ON” lower than “OFF”.

The **third parameter** for each relay determines the pump group. You can have two groups of pumps, and all similar duties within that group will operate together.

**P212, P222, P232, P242, P252, P262, P272, P282, P292, P572**

*Relay Pump Group*

By **default**, all pump groups are set to **1**, but if you want to have another group, then set this parameter to 2, for each pump relay that should operate together as part of a second group.

The **fourth parameter**, and the **fifth parameter** for each relay set the **pump "ON"** and **"OFF"** points, which are entered in **Measurement units P104**. For **pump down** the **"ON"** is set **higher than "OFF"**. For **pump up** then **"ON"** is set **lower than "OFF"**. See the appropriate **pump duty, function table (P212, 222, 232, 242, 252, 262)** for further information.

**P213, P223, P233, P243, P253, P263, P273, P283, P293, P573**

*Relay Setpoint 1*

This parameter determines the **"ON"** point of the pump.

**P214, P224, P234, P244, P254, P264, P274, P284, P294, P574**

*Relay Setpoint 2*

This parameter determines the **"OFF"** point for the pump.

When a relay is being used for a **pump by time** function, then the **sixth parameter** will determine the maximum time the pump will be allowed to run before it is switched off and the next pump takes over.

**P215, P225, P235, P245, P255 P265, P275, P285, P295, P575**

*Relay Setpoint 3*

This parameter determines the **Maximum Time** the pump will be allowed to **run** before being switched **"OFF"** and is entered in minutes.

The pump will switch off either at its **"OFF"** level **Relay Setpoint 2 (P214, 224, 234, 244, 254, 264, 274, 284, 294, 574)** or its **Maximum Run Time Relay Setpoint 3 (P215, 225, 235, 245, 255, 265, 275, 285, 295, 575)**, whichever occurs **first**.



### Common Relay parameters

#### *P216, 226, 236, 246, 256, 266, 276, 286, 296, 576 – Relay Allocation*

This parameter determines which input the relay will act on. You can set it to the transducer (default), or the optional auxiliary (current) input, or an average of the two. In most cases, this will not need to be changed from the default.

OPTION	DESCRIPTION
<b>1 = Xducer 1 (Default)</b>	Relay acts on Xducer 1 calculated values
2 = Xducer 2	Relay acts on Xducer 2 calculated values
4 = Average of 1 & 2	Relay acts on the resulting average levels of two signal inputs.
5 = Differential of 1 & 2	Relay acts on the resulting differential level of two signal inputs.

#### *P217, 227, 237, 247, 257, 267, 287, 297, 577 – Relay Closures*

The Quantum<sup>2</sup> will record how many times each relay is closed, this parameter displays the number of times the relay has activated since the relay has been in use. It can be reset with any value.

#### *P218, 228, 238, 248, 258, 268, 278, 578 – Relay Fail Safe*

The Quantum<sup>2</sup> has a general fail-safe parameter **P808**. However, this can be overridden so that each individual relay has its own independent fail-safe mode.

This parameter determines what the relay will do in the event of the **Failsafe Time (P809)** expiring.

OPTION	DESCRIPTION
<b>0 = Default</b>	Relay assumes system default mode set in <b>P808</b>
1 = Hold	Relay remains in its current state
2 = De-energise	Relay will De-energise
3 = Energise	Relay will energise

### ***Pump Trips***

When using digital inputs to monitor pump running status and assign relays to "Pump Reset" this function allows for a pre-programmed number of pump "fails" (P307 Trip limit) to be automatically reset before putting a pump out of service.

A pump "fail" is defined as the change of state of the trip signal from normal condition to failed. At the point of failure both the consecutive trip counter and the 24-hour rolling counter will be advanced by an increment of 1. After any such pump "fail" is observed the unit will initiate a "cooling" down period (P308 Reset Interval) before initiating an automatic reset (Reset Pulse P309), provided the level in the sump is above the specified minimum level (Prime Level P349).

At this point, the pump has been reset and will operate as normal the next time its 'ON' setpoint is reached. If the pump then successfully pumps to its 'OFF' setpoint, thereby completing a successful pump cycle, then the consecutive trip counter will be reset and the 24-hour rolling counter preserved. When any Pump Trip counter exceeds the number of trips allowed (P307 Trip Limit) in any rolling 24-hour period, starting with the first increment of the Trip counter or the pump fails consecutively, exceeding the number of consecutive trips (Maximum Attempts P300) without completing a successful pump cycle, that pump will be put out of service and will not be rest until such time that the fail condition is removed.

#### ***P307 Trip Limit***

This parameter sets the maximum number of pump "fails" allowed in any 24-hour rolling period.

#### ***P308 Reset Interval***

This parameter sets the "cooling" off period prior to a Reset Pulse being initiated.

#### ***P309 Reset Pulse***

This parameter determines the duration of the Reset Pulse.

#### ***P310 Pump 1 Trip***

This parameter is a "Read Only" parameter and displays the number of times that Pump 1 has "tripped" since the last successful Reset was performed.

*P311 Pump 2 Trip to P319 Pump Trip 10*

These parameters are "Read Only" and display the same information as **P310 Pump Trip 1** for **Pump Trip 2** to **10**.

*Pump "Advanced" Parameters*

The following parameters are used to set the "Advanced" Pump features.

*Pump Run On*

This feature is used to periodically allow the pumps to continue operating below their normal "OFF" point, in order to discharge any sediment that may have settled at the bottom of the vessel.

*P349 Prime Level*

Sets the required level to ensure pumps are fully primed after a pump run on has occurred. Following a pump run on, any pump, whose "ON" point is below the Prime Level will be held "OFF" until the Prime Level has been exceeded.

*P350 Run Interval*

Set required time period, in hours, at which pump run on should occur.

*P351 Run Duration*

This parameter sets the length of time, in seconds, that pumps will run on for, it should be noted that only one run on is allowed per Run Interval.

*Starting*

This feature is used to reduce the effects of power surges, caused by switching of pumps, in the following instances, (**P352 Power surge** (mains or hydraulic) that is generated when multiple pumps are started simultaneously, (**P353 Power resumption** following a power failure.

*P352 Start Delay*

Set the required time period, in seconds, that should elapse between pumps starting. **Default = 10 seconds.**

*P353 Power Delay*

Set the required time period, in seconds, that should elapse before pumps can start following a power failure. **Default = 10 seconds.**

### Stopping

If required, this feature will **prevent** pumps, with a **common “OFF” point** being switched off all at the same time pumps will be switched “OFF” in turn as determined by the **delay** set in **P348 Stop Delay**.

#### *P348 Stop Delay*

Set the required time period, in seconds, that should elapse between pumps stopping. **Default = 0.0 seconds**.

### Pump Exercising

This feature is used to reduce idle pump corrosion and sediment build up. Pumps can run after a specified **Idle Time (P355)** for a determined period of **Exercise time (P356)**, providing a **Minimum head /level (P357)** is present and all other pumps are switched off.

#### *P354 Exercise Enable*

This parameter determines if Pump Exercising is enabled or disabled.

OPTION	DESCRIPTION
<b>0 = No (Default)</b>	Pump exercising disabled
1 = Yes	Pump exercising is enabled

#### *P355 Idle Time*

Sets the Idle Time (in minutes) to elapse before Pump Exercising is to be activated. **Default = 720 minutes**

#### *P356 Exercise Time*

Set the required Exercise Time in seconds. **Default = 30 seconds**

#### *P357 Minimum Head*

To prevent the dry running and the possibility of cavitation, of the pump, enter the minimum level (head) of material, in measurement units (P104), that is to be present before permitting pump exercising to take place.

### Wall Cling

To reduce material, build up (such as fat), on the wall of the sump or vessel, at the “normal” material level the pump setpoints can be varied within a specified band.

For Pump Down applications the relay setpoints for the pumps will be randomly varied within the band specified, somewhere below ON, but to a maximum of the setting, and somewhere higher than OFF, but to a maximum of the setting.

For Pump Up applications the relay setpoints for the pumps will be randomly varied within the band specified somewhere higher than ON, but to a maximum of the setting, and somewhere lower than OFF, but to a maximum of the setting.

#### *P360 Wall Cling*

Enter the maximum band, of variation, required in metres.

### Storm

This facility enables all pumps to be **disabled (P370)** during a storm condition to prevent the futile running or potential damage due to the continued use of pumps during flood conditions. Provision is also made to allow a maximum **time period (P371)** for which pumps will remain disabled during such conditions. For this function to operate a relay must have been assigned to Storm and have Upper and Lower storm setpoints set. See **P210, 220, 230, 240, 250 = 3 (Control) P211, 221, 231, 241, 251, Relay Function =2 (Storm)** for further details.

#### *P370 Pump Disable*

This parameter sets the action required during a flood condition.

OPTION	DESCRIPTION
0 = Disabled	Pumps disabled during storm condition.
<b>1 = Normal (Default)</b>	Normal pump operation during storm condition.

#### *P371 Disable Time*

This parameter will set the maximum time pumps will remain disabled if P370 = 0 Enter desired time in minutes. **Default = 30 minutes**

**Rate Method**

The following parameters are used in conjunction with the RMA function.

*P116 Rate Calc.*

This parameter sets the type of rate calculation used with the RMA function.

OPTION	DESCRIPTION
<b>0 = Linear (Default)</b>	RMA function will be calculated based upon the rate of change of <b>Level</b> . RMA Rate measurement units are in <b>Measurement Units (P104)</b> per <b>Minute</b> .
1 = Volume	RMA function will be calculated based upon the rate of change of <b>Volume</b> (flowrate). Rate units are <b>Volume Units</b> per <b>Second</b> . Note, vessel shape and dimensions must be set to use this option, see volume section for more information.

*P117 RMA Delay*

This parameter determines the delay in cycles before the RMA function is activated after power up (after the first ping), returning to run mode from program mode or after a pump failure i.e. an alarm won't be considered until after this delay. **Default = 0.**

## Digital Inputs

### About Digital Inputs

The digital inputs are used to provide the Quantum<sup>2</sup> with information on the operational status and condition of pumps, valves, and other process control devices. Based on the information supplied, by the inputs, the Quantum<sup>2</sup>, will make intelligent decisions and modify its control regime to meet the demand of the prevailing operational requirements.

The parameters used to program the Digital inputs are as follows:

#### Common Parameters P300 to P306

**Digital Input 1 P372 to 374      Digital Input 2 P375 to 377**

**Digital Input 3 P378 to 380      Digital Input 4 P381 to 383**

**Digital Input 5 P384 to 386      Digital Input 6 P387 to 389**

**Digital Input 7 P390 to 392**

### Common Parameters Set-up

These parameters determine specific operational criteria for digital input functions and are common to each digital input.

### Input Type

The digital inputs can be either voltage source, where Quantum<sup>2</sup> will supply the switching voltage, or voltage synch, where the switching voltage is supplied by the input from the device, for full details see **Chapter 2 Installation**. Both voltage source and voltage synch. inputs can be configured for **N.O.** or **N.C.** operation as determined by the digital input **Type P372, 375, 378, 381, 384, 387, 390** when set to **1= Input N.C.**, Quantum<sup>2</sup> will recognise a **closed** condition, D.C. **signal** voltage **present** at input, as a healthy condition, alternatively, an **open** condition, D.C. **signal** voltage **not present** at input, indicating a healthy condition, can be chosen as a valid input by selecting **2=Input N.O.**

## Input Function

Individual inputs can be configured for any one of several **Functions** as determined by **P373, 376, 379, 382, 385, 388, 391** these functions are as follows:

1. **Device Fail** - Input will provide a signal indicating a "failure" or the presence of a "run" signal from the device. When using digital inputs to detect a "run" condition the input is assumed to be in its operational status until the expiry of **P304 Input Delay** which is used to determine the delay time that occurs from the time that the device is called to "run" and the digital input providing a signal appropriate to its operational status.
2. **Duty** - Input will provide a signal to manually select the lead device.
3. **Override ON** - Input will provide a signal to override all selected pump setpoints "ON".
4. **Override OFF** - Input will provide a signal to override all selected pump setpoints "OFF".
5. **Reset** - Input will provide a signal to reset all Device Fail signals.



## Device Fail

The digital inputs are used to indicate a 'fail' situation which effect devices, which are connected to the relay outputs of the Quantum<sup>2</sup>, e.g. failure of a pump, screen, valve, etc. This information is then used to initiate changes to the Quantum<sup>2</sup>'s control regime to meet the demands of the situation.

Let us consider the example of an application using 2 pumps, each pump has the capability to provide a signal indicating its 'run' status. Each pump is connected and controlled by one of the Quantum<sup>2</sup> relay outputs, the duty and setpoints have been programmed as detailed in **Using the Relays**, earlier in this chapter. The signals providing details on the pumps 'run status' are connected to the digital inputs as described in **Chapter 2 Installation**, and the input **Type P372, 375, 378, 381, 384, 387, 390** is configured as detailed in **Input Type**, earlier in this chapter.

**Pump 1** is connected and programmed to operate on **Relay 1**

**Pump 2** is connected and programmed to operate on **Relay 2**

**Pump 1 Fail** signal is connected to **Digital Input 1**

**Pump 2 Fail** signal is connected to **Digital Input 2**

Each digital input must be assigned to the device relay output that it relates to, this is determined by **Assignment P374, 377, 380, 383, 386, 389, 392**. In the case of our example **Digital Input 1** will be assigned to **Relay 1 (P374 = 1)** and **Digital Input 2** will be assigned to **Relay 2 (P377 = 2)**.

When the level rises to the ON Setpoint of Relay 1, the relay will energise and Pump 1 will 'start', in the normal manner. If the pump starts and correctly runs no change of 'run' status will be seen on the digital input and the pump(s) will be allowed to operate as programmed.

Should a pump **fail**, a change of 'run' status would be seen and a **Device Fail**, condition would be detected on the corresponding digital input, this will result in the relay for the 'failed' pump being de-energised and the pump being switched OFF. The setpoints of the 'failed' pump will then be passed to the second pump, which will take over to complete the pumping operation.

The decision on whether or not to attempt to start the failed pump on subsequent pump cycles will be determined by **P300 Max. Attempts**. Once the number of attempts stipulated have been made the pump will be put out of service until such time the Device Fail input is cleared by a **Reset (P391 = 4)** on Digital Input 7. Alternatively, the +/- key can be used as a as a Hot Key, which when pressed, whilst the unit is in RUN, will give details of any **Device Fail** and provides prompts to **Reset** any failures to the **no fault** condition.

### **Duty**

When this function is selected the digital inputs are used to determine, via an 'auto/manual' switch, which one of the devices, connected to the relay outputs of the Quantum<sup>2</sup>, will be the "lead" or "duty" device.

Consider the example of an application using 2 pumps. Each pump is connected and controlled by one of the Quantum<sup>2</sup> relay outputs, the pump duty and setpoints have been programmed as detailed in **Using the Relays**, earlier in this chapter. The signals providing details on the "lead" or "duty" pump 'status' are connected to the digital inputs as described in **Chapter 2 Installation**, and the input **Type P372, 375, 378, 381, 384, 387, 390** is configured as detailed in **Input Type**, earlier in this chapter.

**Pump 1** is connected and programmed to operate on **Relay 1**

**Pump 2** is connected and programmed to operate on **Relay 2**

**Pump 1 Duty** signal is connected to **Digital Input 3**

**Pump 2 Duty** signal is connected to **Digital Input 4**

The type of switch to be used to determine the duty is selected and configured as detailed in **P301 Switch Mode**.

### **Standard Switch Mode (P301 = 0 Standard)**

When a standard rotary type switch is used, to determine auto/manual duty one input per device is required, with each input being assigned to the appropriate device relay output that it relates to, this is determined by **Assignment P374, 377, 380, 383, 386, 389, 392**. In the case of our example **Digital Input 3** will be assigned to **Relay 1 (P380 = 1)** and **Digital Input 4** will be assigned to **Relay 2 (P383 = 2)**.

When the **duty switch** is in the “**auto**” position, no signals are present on either Digital Input 3 or Digital Input 4 and devices will run in the “**auto**” mode, as determined by the Quantum<sup>2</sup>, in accordance with its programmed settings. If a signal is seen on Digital Input 3, **duty switch** selected for **Pump 1**, then the pump connected to Relay 1 will assume the role of “**lead**” / “**duty**” pump, regardless of the settings programmed in the Quantum<sup>2</sup>.

When the level rises to the **ON Setpoint**, for the **first** pump, relay 1 will energise and Pump 1 will ‘start’, in the normal manner. If the level continues to rise, then relay 2 will energise and Pump 2 will start in accordance with the settings programmed for pump 2.

If a signal is seen on Digital Input 4, **duty switch** selected for **Pump 2**, then the pump connected to Relay 2 will assume the role of “**lead**” / “**duty**” pump, regardless of the settings programmed in the Quantum<sup>2</sup>. When the level rises to the **ON Setpoint**, for the **first** pump, the relay 2 will energise and Pump 2 will ‘start’, in the normal manner. If the level continues to rise, then relay 1 will energise and Pump 1 will start in accordance with the settings programmed for pump 2.

### **Binary Switch Mode (P301 = 1Binary)**

When a binary switch is used, to determine auto/manual duty, the number of inputs required will be dependent on the number of devices to be included in the duty selection. In this mode, the duty device will be selected according to the binary input present on the appropriate inputs and there is therefore no requirement to assign the duty switch inputs to specific device relay. The selection of the Lead/Duty device is determined by the presence of an input as detailed in the table below, where **0** = **no input** present and **1** = **input** present.

DUTY INPUT 1	DUTY INPUT 2	DUTY INPUT 3	DUTY INPUT 4	LEAD/DUTY DEVICE
0	0	0	0	Auto
1	0	0	0	Relay 1
0	1	0	0	Relay 2
1	1	0	0	Relay 3
0	0	1	0	Relay 4
1	1	1	0	Relay 5
0	1	1	0	Relay 6
1	1	1	0	Relay 7
0	0	0	1	Relay 8
1	0	0	1	Relay 9
0	1	0	1	Relay 10

Consider the example of an application using 2 pumps. Each pump is connected and controlled by one of the Quantum<sup>2</sup> relay outputs, the pump duty and setpoints have been programmed as detailed in **Relays**, earlier in this chapter. The signals providing details on the “lead” or “duty” pump ‘status’ are connected to the digital inputs as described in **Chapter 2 Installation**, and the input **Type P372, 375, 378, 381, 384, 387, 390** is configured as detailed in **Input Type**, earlier in this chapter.

**Pump 1** is connected and programmed to operate on **Relay 1**

**Pump 2** is connected and programmed to operate on **Relay 2**

**Duty Input 1** signal is connected to **Digital Input 3**

**Duty Input 2** signal is connected to **Digital Input 4**

When no signals are present on either Digital Input 3 or Digital Input 4 then devices will run in the “**auto**” mode, as determined by the Quantum<sup>2</sup>, in accordance with its programmed settings. If a signal is seen on Digital Input 3, **duty** selected for **Pump 1**, then the pump connected to Relay 1 will assume the role of “lead” / “duty” pump, regardless of the settings programmed in the Quantum<sup>2</sup>. When the level rises to the **ON Setpoint**, for the **first** pump, relay 1 will energise and Pump 1 will ‘start’, in the normal manner. If the level continues to rise, then relay 2 will energise and Pump 2 will start in accordance with the settings programmed for pump 2.

If a signal is seen on Digital Input 4, **duty** selected for **Pump 2**, then the pump connected to Relay 2 will assume the role of “lead” / “duty” pump, regardless of the settings programmed in the Quantum<sup>2</sup>. When the level rises to the **ON Setpoint**, for the **first** pump, the relay 2 will energise and Pump 2 will ‘start’, in the normal manner. If the level continues to rise, then relay 1 will energise and Pump 1 will start in accordance with the settings programmed for pump 2.

### **Override**

A digital input can be assigned to receive an input, which will **override** the setpoints of the pumps and **start** them, as determined by the **Override Level (P306)** and providing the level is above the **Min. Override (P303)**, immediately after the expiry of the **Override Delay (P302)**. A digital input can also be assigned to receive an input, which will **override** the setpoints of the pumps and **stop** them immediately after the expiry of the **Override Delay (P302)**.

### **Reset**

This option is only available on Digital Input 7 **P391 = 5** when selected a valid signal received on this input will **Reset** all **Device Fail** signals to the **no fault** condition. When using this function, the unit will check all inputs for such conditions so there is no requirement to assign the input to a specific relay output. Alternatively, the **+/-** key has been allocated as a Hot Key, which when pressed will give details of any **Device Fail** and provides prompts to **Reset** any failures to the **no fault** condition.

### **Digital Input Parameters**

#### *Common Par.*

These parameters are common to each of the seven digital inputs and set specific operational criteria for functions.

### *P300 Max.Attempts*

When digital inputs are used to detect device failure this parameter determines the number of attempts that will be made before failing the device and putting it out of service. When the number of attempts is set to '0', there is no restriction on the number of starts. The digital inputs will provide a fail signal in the normal manner and initiate any action as required, but the device will not be put out of service. Any figure other than 0 will determine the number of attempts that will be made to start the device before putting it out of service until such time that the input is reset. Set the number of attempts Min. 0, Max 99.

### *P301 Switch Mode*

When an external duty switch is used this can be connected via the digital inputs and facilitate the selection of the duty device manually, thereby overriding the duty programmed within the unit. This parameter determines the type of switch in use.

OPTION	DESCRIPTION
<b>0 = Standard</b>	A standard switch, e.g. rotary switch, can be used with one switch position and a digital input required for each pump.
1 = Binary	To reduce the number of digital inputs used, for manual duty selection, a binary switch can be supplied. Max. No. of digital inputs required being four.

### *P302 Override Delay*

A digital input can be assigned to receive an input, which will override the setpoints of the pumps and start or stop them, immediately after the expiry of the Override Delay, dependent on the selected Digital Input **Function P373, 376, 379, 382, 385, 388, 391 = 3 (Override "ON")** or **4 (Override "OFF")** and providing the level is above the **Min. Override (P303)**, when **Override "ON"** is selected. Enter the required delay time in minutes.

### *P303 Min Override*

Determines the minimum level required before an **Override Delay (P302)** will be in effect when Digital Input **Function P373, 376, 379, 382, 385, 388, 391 = 3 (Override "ON")**. Enter the required level in **Measurement Units (P104)**.

### *P304 Input Delay*

This parameter determines the delay applied, from the time a device (relay) is called to "run" and when the status of the digital input is recognised as a valid input. If the digital input is used to detect a "running" signal this parameter should be set to reflect the time it takes from the device being called to "run" to the input being in its operational status. Enter the required time in seconds.

### *P305 Input Filter*

This parameter is used to ignore spurious changes of state on the digital inputs and determines the time that a change of state must be present before it is recognised as a valid input. Enter the required time in seconds.

### *P306 Override Level*

This parameter will determine which pumps setpoints will be overridden when Digital Input **Function P373, 376, 379, 382, 385, 388, 391 = 3 (Override "ON")**. Only pumps with, **normal "ON"**, setpoints **below the Override Level** will be activated when an **Override "ON"** condition exists and that the **Override Delay (P302)** and **Min Override (P303)**, where required, have been satisfied. Enter the required level in **Measurement Units (P104)**.

### Digital Input

The following parameters are used to configure the use of the digital inputs.

#### *P372, 375, 378, 381, 384, 387, 390 Type*

Determines the way digital inputs will be recognised by Quantum<sup>2</sup>.

OPTION	DESCRIPTION
<b>1 = Input N.C (Default Input 1 -6)</b>	Quantum <sup>2</sup> recognises a closed condition, D.C. signal voltage present at the input, as a healthy/run condition.
<b>2 = Input N.O (Default Input 7)</b>	Quantum <sup>2</sup> recognises an <b>open</b> condition, D.C. <b>signal</b> voltage <b>not present</b> at the input, as a healthy/run condition.

#### *P373, 376, 379, 382, 385, 388, 391 Function*

This parameter will set the function of the digital Input.

OPTION	DESCRIPTION
<b>1 = Device Fail (Default Input 1 -6)</b>	Digital input is used to Fail, (put out of service), a device connected to the relay specified in <b>P374, 377, 380, 383, 386, 389, 392 Assignment</b> .
2 = Duty	Digital input is used to select the device, (pump), connected to the relay specified in <b>P374, 377, 380, 383, 386, 389, 392 Assignment</b> as the current duty device (pump).
3 = Override "ON"	Digital input is used to provide a signal to activate an <b>Override "ON"</b> condition of pumps as determined by <b>P302 Override Delay, P303 Min. Override</b> and <b>P306 Override Level</b> .
4 = Override "OFF"	Digital input is used to provide a signal to activate an <b>Override "OFF"</b> condition of pumps after the expiry of the delay time as determined by <b>P302 Override Delay</b> .
<b>2 = Reset Digital Input 7 only. (Default Input 7)</b>	Input is used to <b>Reset</b> all <b>Device Fail</b> conditions. Alternatively, the +/- key can be used, whilst in RUN, to <b>Reset</b> any <b>Device Fail</b> .



*P374, 377, 380, 383, 386, 389, 392 Assignment*

This parameter assigns the digital input to the appropriate device relay that the **Function**, (**P373, 376, 379, 382, 385, 388, 391**), is to be applied, where appropriate.

OPTION	DESCRIPTION
<b>0 = None (Default)</b>	Digital Input is not assigned to any relay
1 = Relay 1	Digital input is assigned to Device connected to Relay 1.
2 = Relay 2	Digital input is assigned to Device connected to Relay 2.
3 = Relay 3	Digital input is assigned to Device connected to Relay 3.
4 = Relay 4	Digital input is assigned to Device connected to Relay 4.
5 = Relay 5	Digital input is assigned to Device connected to Relay 5.
6 = Relay 6	Digital input is assigned to Device connected to Relay 6.
7 = Relay 7	Digital input is assigned to Device connected to Relay 7.
8 = Relay 8	Digital input is assigned to Device connected to Relay 8.
9 = Relay 9	Digital input is assigned to Device connected to Relay 9.
10 = Relay 10	Digital input is assigned to Device connected to Relay 10.

### **Float Switch (FS) Backup**

#### *About Float Switch Backup*

This digital feature is used with a float switch, where it can be used alongside a transducer or as a backup method for when a transducer goes into failsafe.

The high input will have a timer and a level set point, which will allow for the unit to power on every pump below the set point for the specified amount of time as set in **P332 Pump Run Time**.

The low input will simply switch off all the pumps that have been set on the controller.

### **Common Par**

#### *P330 Mode of Operation*

OPTION	DESCRIPTION
<b>0 = Off (Default)</b>	Float Switch Backup is not used
1 = Always	Backup will be active continuously and will always respond to an input from a Backup device.
2 = On Xdr Fail	Backup will only be active at times when the unit has gone into a Failsafe mode.

#### *P330 Input Filter*

This parameter can be used to ignore spurious changes of state on the digital inputs, and determines the time that a change of state has to be present before it is recognised as a valid input.

Enter a value in seconds: Min = 1 (**Default**), Max = 999.

#### *P330 Pump Run Time*

This parameter tells the unit to switch the pumps off after the specified amount of time, if the level of the float switch has not been reached.

Enter a value in minutes: Min = 0.1 (**Default**), Max = 9999.

## Digital Input

The following parameters are used to configure the use of the digital inputs.

### *P333, 336, 339, 342, 345, 363 Type*

Determines the way digital inputs will be recognised by the Quantum<sup>2</sup>.

OPTION	DESCRIPTION
<b>1 = Input N.C. (Default 1-6)</b>	The Quantum <sup>2</sup> recognises a <b>closed</b> condition, DC <b>signal</b> voltage <b>present</b> at the <b>input</b> , as a healthy/run condition.
2 = Input N.O.	The Quantum <sup>2</sup> recognises an <b>open</b> condition, DC <b>signal</b> voltage <b>isn't present</b> at the <b>input</b> , as a healthy/run condition.

### *P334, 337, 340, 343, 346, 364 Function*

This parameter is used to identify what the float switches function is to be.

OPTION	DESCRIPTION
<b>0 = Off (Default)</b>	Input is not used for Float Switch Backup
1 = Low	Float Switch is set at low level to turn pumps off.
2 = High	Float Switch is set at a high level to turn pumps on.

### *P335, 338, 341, 344, 365 Forced Level*

This parameter is used to enter the value, in measurement units (**P104**) where in the event of a Backup condition '**Forced Level**' will determine the level that the unit will assume is present and switch on the pumps in accordance with their setpoints. Enter a value in measurement units (**P104**): Min 0.1 (**Default**), Max = 9999

#### Important Notice

When programming the unit for FS Backup and you attempt to use a digital input that has already been assigned, a message will appear on the display 'Change use'. Pressing 'Enter' will overwrite what the input has already been programmed to do, pressing 'Cancel' will leave the digital input as previously programmed and will allow you to use a different input for FS Backup.

## Tariff Guard

### Set Up

#### P393 Enable

This parameter determines if Energy Saving is in use or not.

OPTION	DESCRIPTION
<b>0 = Off (Default)</b>	Energy saving is switched <b>Off</b>
1 = On	Energy saving is switched <b>On</b>

'Tariff active' will appear on the Aux display of the unit when unit is in Tariff Guard mode. This feature is available from firmware version 7.5.1 and onwards.

#### P394 Lead Time

This parameter determines the time, prior to a High Tariff period, at which the vessel will be pumped down to the lowest pump OFF level. Enter desired time in **minutes**.

#### P395 Lag Time

This parameter determines the time, after a High Tariff period, that the vessel will be pumped down, (if required), by the first duty pump to the lowest pump Off level. If after the Lag Time has expired the pump has not reached its Off point it will continue to pump until the Off point is reached. On expiry of the Lag Time all pumps will assume their normal operation and will be switched On and Off according to their respective setpoints. Enter desired time in **minutes**.

#### P396 Min. Pump Run

This parameter determines the minimum amount of time that a pump will be allowed to run during a High Tariff period, if required, and is used to prevent excessive wear or damage to the pump. Enter desired time in **seconds**.

#### P397 Minimum Head

This parameter determines the minimum head (level) of material required to be present before a pump will be allowed to run, if required, during a High Tariff period and is used to ensure that a prime level for the pumps is maintained. Enter desired level in **Measurement Units (P104)**.

### *P398 Overflow Level*

This parameter determines the maximum level to which the vessel will be allowed to fill. Should this level be reached all pumps will be switched ON, to draw the level down, as required, irrespective of the control sequence in operation. Enter desired level in **Measurement Units (P104)**.

### **Peak Times**

*Up to ten separate Peak Tariff periods can be programmed in to the Quantum<sup>2</sup>, these periods can be set for a specific date and time or at a specific time during a period of dates or on a daily or weekly basis. The following parameters are used to set these "Peak Times".*

#### *P400, 406, 412, 418, 424, 430, 436, 442, 448, 454 PT Day*

This parameter sets the **day** on which the "Peak Time" will be in effect.

OPTION	DESCRIPTION
<b>0 = Off (Default)</b>	Peak time is not in effect
1 = Every	Peak time will be in effect <b>everyday</b>
2 = Monday	Peak time will be in effect <b>Monday</b>
3 = Tuesday	Peak time will be in effect <b>Tuesday</b>
4 = Wednesday	Peak time will be in effect <b>Wednesday</b>
5 = Thursday	Peak time will be in effect <b>Thursday</b>
6 = Friday	Peak time will be in effect <b>Friday</b>
7 = Saturday	Peak time will be in effect <b>Saturday</b>
8 = Sunday	Peak time will be in effect <b>Sunday</b>

#### *P400, 406, 412, 418, 424, 430, 436, 442, 448, 454 PT Day*

This parameter sets the **week** on which the "Peak Time" will be in effect.

OPTION	DESCRIPTION
1 = First	Peak time effective in the <b>first</b> week of the month
2 = Second	Peak time effective in the <b>second</b> week of the month
3 = Third	Peak time effective in the <b>third</b> week of the month
4 = Fourth	Peak time effective in the <b>fourth</b> week of the month
5 = Last	Peak time effective in the <b>Fifth</b> week of the month
<b>6 = Every (Default)</b>	Peak time effective <b>every</b> week of the month

*P402, 408, 414, 420, 426, 432, 438, 444, 450, 456 PT Start Pk.*

This parameter sets the **date** on which the "Peak Time" will **start**. Enter the desired Start **Date** in DD:MM format.

*P403, 409, 415, 421, 427, 433, 439, 445, 451, 457 PT End Pk.*

This parameter sets the **date** on which the "Peak Time" will **end**. Enter the desired End **Date** in DD:MM format.

*P404, 410, 416, 422, 428, 434, 440, 446, 452, 458 PT1 Start.*

This parameter sets the **time** at which the "Peak Time" will **start**. Enter the desired Start **Time** in HH:MM format.

*P405, 411, 417, 423, 429, 435, 441, 447, 453, 459 PT1 End*

This parameter sets the **time** at which the "Peak Time" will **end**. Enter the desired end **time** in HH:MM format.

## Data Log parameters

The data log parameters contain the following information:

### Totaliser Audits

#### *P460 to P479 Total Audits*

When Pump Volume is enabled, parameters **P460-P479** show the **date** and pumped **volume** total for the last **ten days**, the first on the list are the most recent and last ones are the oldest. When all ten total audits are full the oldest is pushed out and all totals increment through to allow the new days total to be registered in the first day's total audit parameter allocation.

#### *P480 Clear Logs*

This parameter enables **all** the Total Audits (P460 – P479) to be cleared to factory default values.

### Important Notice

In order to ensure the accuracy of pumped Volume, during a 24-hour period, the Time P932 must be set correctly. And if required, enable Daylight Saving for the appropriate time difference P970 – P979.

### Temperature

The following parameters give information on temperature conditions seen by the **Temperature source (P852)** in °C. All of these parameters are read only and cannot be changed, though if P852 is changed they will be reset.

#### *P580 Minimum Temperature*

This parameter displays the minimum temperature recorded.

#### *P581 Minimum Temperature Date*

This parameter displays the date when the minimum temperature was recorded.

#### *P582 Minimum Temperature Time*

This parameter displays the time when the minimum temperature was recorded.

*P583 Maximum Temperature*

This parameter displays the maximum temperature recorded.

*P584 Maximum Temperature Date*

This parameter displays the date when the maximum temperature was recorded.

*P585 Maximum Temperature Time*

This parameter displays the time when the maximum temperature was recorded.

*P586 Current Temperature*

This parameter displays the current temperature.

**Pump Logs**

*P510 Pump 1 Hours*

This parameter displays the current total running hours for Pump 1. Any value from 0 - 9999 can be entered to facilitate any update to the stored total for any reason e.g. a replacement pump being fitted.

*P511 Pump 1 Starts*

This parameter displays the current total pump starts for Pump 1. Any value from 0 - 9999 can be entered to facilitate any update to the stored total for any reason e.g. a replacement pump being fitted.

*P512 Pump 1 Starts/Hour*

This parameter displays the current pump Starts/Hour for Pump 1. Any value from 0 - 9999 can be entered to facilitate any update to the stored total for any reason e.g. a replacement pump being fitted.

*P513 Pump 1 Run On*

This parameter displays the current number of Pump Run On, which have occurred, for Pump 1. Any value from 0 - 9999 can be entered to facilitate any update to the stored total for any reason e.g. a replacement pump being fitted.



### *P514 Pump 1 Draw*

This parameter displays the current Draw Rate for Pump 1, which is used to calculate the pump efficiency. Any value from 0 - 9999 can be entered to facilitate any update to the stored total for any reason e.g. a replacement pump being fitted.

### *P515 Pump 1 Efficiency*

This parameter displays the current value for Pump 1 Efficiency, which is used to calculate the pump efficiency and will update with any change to the **Pump Draw Rate (P515)**.

### *P516 - P521 Pump 2*

These parameters contain the same information as above for Pump 2.

### *P522 - P527 Pump 3*

These parameters contain the same information as above for Pump 3.

### *P528 - P533 Pump 4*

These parameters contain the same information as above for Pump 4.

### *P534 - P539 Pump 5*

These parameters contain the same information as above for Pump 5.

### *P540 - P545 Pump 6*

These parameters contain the same information as above for Pump 6.

### *P546 - P551 Pump 7*

These parameters contain the same information as above for Pump 7.

### *P552 - P557 Pump 8*

These parameters contain the same information as above for Pump 8.

### *P558 - P563 Pump 9*

These parameters contain the same information as above for Pump 9.

### *P564 - P569 Pump 10*

These parameters contain the same information as above for Pump 10.

**Pumped Volume**

**Set Up**

*P205 Pump Vol. Enable*

This parameter determines if Pumped Volume is in use or not.

OPTION	DESCRIPTION
<b>0 = Off (Default)</b>	Pump volume calculation is switched <b>Off</b>
1 = On	Pump volume calculation is switched <b>On</b>

*P206 Settle Time*

This parameter determines the time allowed for the level to settle after all pumps have switched Off, in order to avoid any effects of flow back or turbulence, before calculating the Inflow Rate. This parameter is also used in the RMA Alarm function to allow the pumping rate to settle after starting the first pump. Enter desired time in minutes. **Default = 1 minute.**

*P207 Inflow Method*

This parameter determines which method is used to calculate the inflow of material during a pump down cycle.

OPTION	DESCRIPTION
0 = No inflow	Inflow during pumping is not calculated
<b>1 = Average Inflow (Default)</b>	Average between Inflow at time pump started and Inflow after Settle Time used to calculate Inflow during pumping.

## Volume

Your Quantum<sup>2</sup> provides a variety of volume calculation features, **with 11** pre-programmed **vessel shapes**. See **Vessel Shape (P600)** for more information. For each vessel you will need to know the **dimensions (P601-603)** in **Measurement Units (P104)** which are required to calculate the **volume (P604)** which will be displayed in the selected **Volume Units (P605)**.



If your vessel shape does not correspond with any of the pre-programmed vessel shapes, then you can use the **universal calculations**. For this you will need a level/volume graph or chart provided by the vessel manufacturer or you can create one based on the dimensions of the vessel. You can enter up to 32 pairs of breakpoints, and the more you enter, the greater accuracy of the volume calculation will be.

## Conversion



### *P600 Vessel Shape*

This parameter determines which vessel shape is used when utilising "Volume Conversion".

The choices are as shown in the table below, along with the **dimensions** that are required to be entered (**P601-P603**).

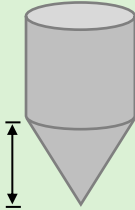
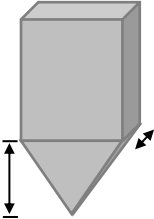
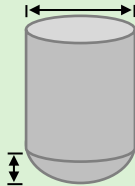
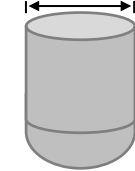
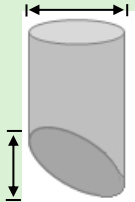
VESSEL SHAPE	P600 VALUE DESCRIPTION	DIMENSIONS
	P600 = 0 ( <b>Default</b> ) Cylindrical Flat Base	Cylinder diameter
	P600 = 1 Rectangular Flat Base	Width and Breadth

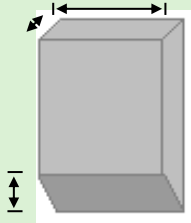
VESSEL SHAPE	P600 VALUE DESCRIPTION	DIMENSIONS
	<p>P600 = 2 Cylindrical Cone Base</p>	<p>Cylinder diameter and height of bottom</p>
	<p>P600 = 1 Rectangular Flat Base</p>	<p>Width and Breadth</p>
	<p>P600 = 4 Parabola Base</p>	<p>Cylinder diameter and height of bottom</p>
	<p>P600 = 5 Flat Sloped Base</p>	<p>Cylinder diameter</p>
	<p>P600 = Flat Sloped Base</p>	<p>Cylinder diameter and height of bottom</p>

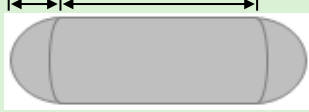
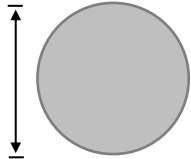
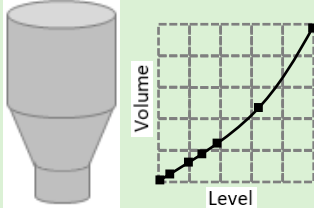
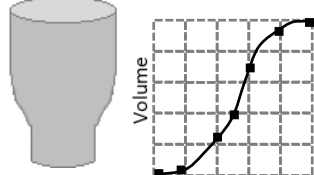
VESSEL SHAPE	P600 VALUE DESCRIPTION	DIMENSIONS
	<p>P600 = 7 Rectangular flat sloped base</p>	<p>Width and breadth of rectangular section and height of bottom</p>
	<p>P600 = 8 Horizontal cylinder with flat ends</p>	<p>Cylinder diameter and tank length</p>
	<p>P600 = 9 Horizontal cylinder with parabolic ends</p>	<p>Cylinder diameter, length of one end and section, and tank length</p>
	<p>P600 = 10 Sphere</p>	<p>Sphere diameter</p>
	<p>P600 = 11 Universal linear</p>	<p>No dimensions required as level, and volume breakpoints are used</p>
	<p>P600 = 12 Universal curved</p>	<p>No dimensions required as level, and volume breakpoints are used</p>

*P601-P603 Vessel Dimensions*

These three parameters are used to enter the dimension required to calculate the volume. The dimensions required are as shown below and are entered **Measurements Units (P104)**.

<b>VESSEL SHAPE</b>	<b>P601</b>	<b>P602</b>	<b>P603</b>
P600 = 0 Cylindrical flat base	Cylinder Diameter	Not required	Not required
P600 = 1 Rectangular flat base	Not required	Width of rectangle	Breadth of rectangle
P600 = 2 Cylindrical cone base	Height of base	Width of rectangle	Not required
P600 = 3 Rectangular pyramid base	Height of base	Width of rectangle	Breadth of rectangle
P600 = 4 Cylindrical parabola base	Height of base	Cylinder diameter	Not required
P600 = 5 Cylindrical half sphere base	Cylinder diameter	Not required	Not required
P600 = 6 Cylindrical flat sloped base	Height of base	Cylinder diameter	Not required
P600 = 7 Rectangular flat sloped base	Height of base	Width of rectangle	Breadth of rectangle
P600 = 8 Horizontal cylinder flat ends	Length of cylinder	Cylinder diameter	Not required
P600 = 9 Horizontal cylinder parabolic ends	Length of cylinder	Cylinder diameter	Length of one end
P600 = 10 Sphere	Sphere diameter	Not required	Not required

*P604 Calculated Volume*

This parameter displays the maximum volume that has been calculated by the Quantum<sup>2</sup> pump controller and is a Read Only parameter. The volume displayed will be shown in cubic meters and is the total volume available between **empty level (P105)** and 100% of **span (P106)**.

*P605 Volume Units*

This parameter determines the units that you wish to display, for volume conversion. It is used in conjunction with **P607 (maximum volume)**, and the units are shown on the display (subject to P810). The choices are:

OPTION	DESCRIPTION
0 = No units	Volume will be totalised with <b>no units</b>
1 = Tons	Volume will be totalised in <b>Tons</b>
2 = Tonnes	Volume will be totalised in <b>Tonnes</b>
<b>3 = Cubic metres (Default)</b>	Volume will be totalised in <b>Cubic metres</b>
4 = Litres	Volume will be totalised in <b>Litres</b>
5 = UK Gallons	Volume will be totalised in <b>UK Gallons</b>
6 = US Gallons	Volume will be totalised in <b>US Gallons</b>
7 = Cubic Feet	Volume will be totalised in <b>Cubic Feet</b>
8 = Barrels	Volume will be totalised in <b>Barrels</b>
9 = lbs (pounds)	Volume will be totalised in <b>lbs (pounds)</b>

*P606 Correction Factor*

This parameter is used to enter a correction factor, when required, such as the specific gravity of the material so that the volume calculated is relative to the actual amount of material that can be contained between **empty level (P105)** and 100% of **span (P106)**. **Default = 1**

*P607 Max Volume*

This parameter displays the actual maximum volume that has been calculated by the Quantum<sup>2</sup>, i.e. **P604 Calculated Volume x P606 Correction Factor**, and is a Read Only parameter. The volume displayed will be shown in **P605 Volume Units** and is the total volume available between **empty level (P105)** and 100% of **span (P106)**.

## Breakpoints

### *P610-P673 Level/Volume Breakpoints*

These parameters are used to create a profile of the vessel when **P600=11 (universal linear)** or **P600=12 (universal curved)**. You should enter breakpoints in pairs, a reading for level and its corresponding volume. The more pairs you enter, the more accurate the profile will be. In the case of universal linear, then enter the level/volume at each of the points where the vessel changes shape. In the case of the universal curved, enter values around each arc tangent, as well as at the top and bottom.

You must enter at least two pairs, and you can enter up to 32 pairs.

### *Universal Linear (P600=11)*

This volume calculation creates a linear approximation of the level/volume relationship and works best if the vessel has sharp angles between each section.

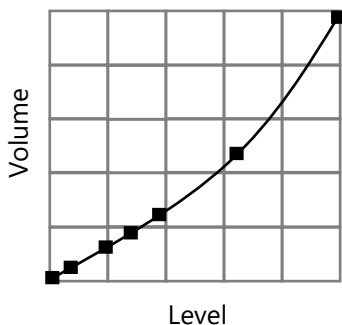

You should enter a level/volume breakpoint for each place where the vessel changes direction, and numerous where the section is slightly curved (mostly linear but has got a small arc). You can enter any number of pairs between 2 and 32.



### *Universal Curved (P600=12)*

This volume calculation creates a curved approximation of the level/volume relationship, and works best if the vessel is non-linear, and there are no sharp angles.

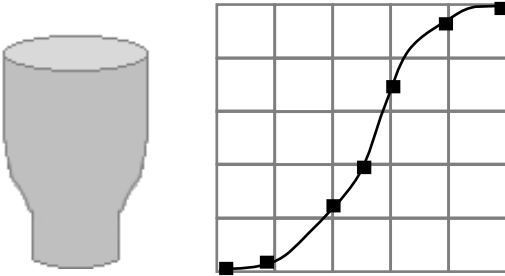

You should enter 2 level/volume breakpoints at the minimum and maximum levels, and several for each place where the vessel has got an arc. You can enter any number of pairs between 2 and 32.

### **Tables**

#### *P696 Reset Breakpoints*

This parameter allows the resetting, to the default value, of all previously set breakpoints (P610-673), without having to access them individually. When it is necessary to reset or amend particular breakpoints this can be achieved by directly accessing the desired parameter (P610-673) and changing as required.

#### *P697 Number of Breakpoints Set*

This parameter allows you to review the number of breakpoints that have been set, without the need to access each individual one in turn, this is a "Read Only" parameter and no values can be entered.

## Pump Efficiency

### Set Up

#### *P187 Pump Eff.*

This parameter determines whether pump efficiency is enabled or disabled.

OPTION	DESCRIPTION
<b>0 = Off (Default)</b>	Pump efficiency is <b>disabled</b>
1 = On	Pump efficiency is <b>enabled</b>

#### *P188 Calib. Delay*

This parameter is used to set a delay, after all pumps have stopped, to allow for any turbulence of the material surface to settle prior to monitoring the level in the vessel and determining the inflow before the next pump cycle commences. The delay time is entered in seconds. **Default = 45 seconds.**

#### Important Notice

When setting the time period for the Calibration Delay (P188) it is important that it does not exceed the time from when all pumps switch Off to the first pump Start during normal operation as it will prevent determining the Inflow and any subsequent calculation of Efficiency.

#### *P189 Cal. Duration*

This parameter sets the time duration over which the pumps performance will be monitored, and the resulting efficiency is calculated.

#### Important Notice

When setting the time period for the Calibration Duration (P189) it is important that it does not exceed the time from one pump Start to the next pump Start during normal operation as it will abort any subsequent calculation of Efficiency.

*P190 Persist Cnt.*

If an alarm is to be used to indicate when the Pump efficiency falls below a predetermined level, this parameter determines the number of consecutive times the pump will be allowed to run, at the reduced efficiency, before the alarm will be activated. The Persist Count can be set to Min. 0, Max 99.

**Default = 6.**

*P191 Demote Pumps.*

When an efficiency alarm is being used this parameter will determine if a pump is to be demoted to the last pump in the duty cycle on activation of the alarm. When Demote Pump is enabled and the efficiency alarm is activated after the predetermined Persist Count (P190) the pump duty will default to a fixed duty regime with the inefficient pump being set to the last pump in the cycle which will be called to start if the level reaches the on point for that pump. A pump which has been demoted will be indicated by the relevant "pump" relay LED "flashing" RED.

OPTION	DESCRIPTION
<b>0 = Off (Default)</b>	Denote pump is <b>disabled</b>
1 = On	Denote pump is <b>enabled</b>

*P192 Demote Flags*

This parameter will indicate, in a binary number format as detailed below, which pumps, if any, have been demoted. Any demoted pump(s) can be reset by entering "0".

0 = None	32 = Pump 6
1 = Pump 1	33 = Pump 1 + 6
2 = Pump 2	34 = Pump 2 + 6
3 = Pump 1 + 2	35 = Pump 1 + 2 + 6
4 = Pump 3	36 = Pump 3 + 6
5 = Pump 1 + 3	37 = Pump 1 + 3 + 6
6 = Pump 2 + 3	38 = Pump 2 + 3 + 6
7 = Pump 1 + 2 + 3	39 = Pump 1 + 2 + 3 + 6
8 = Pump 4	40 = Pump 4 + 6
9 = Pump 1 + 4	41 = Pump 1 + 4 + 6
10 = Pump 2 + 4	42 = Pump 2 + 4 + 6
11 = Pump 1 + 2 + 4	43 = Pump 1 + 2 + 4 + 6
12 = Pump 3 + 4	44 = Pump 3 + 4 + 6
13 = Pump 1 + 3 + 4	45 = Pump 1 + 3 + 4 + 6
14 = Pump 2 + 3 + 4	46 = Pump 2 + 3 + 4 + 6
15 = Pump 1 + 2 + 3 + 4	47 = Pump 1 + 2 + 3 + 4 + 6
16 = Pump 5	48 = Pump 5 + 6
17 = Pump 1 + 5	49 = Pump 1 + 5 + 6
18 = Pump 2 + 5	50 = Pump 2 + 5 + 6
19 = Pump 1 + 2 + 5	51 = Pump 1 + 2 + 5 + 6
20 = Pump 3 + 5	52 = Pump 3 + 5 + 6
21 = Pump 1 + 3 + 5	53 = Pump 1 + 3 + 5 + 6
22 = Pump 2 + 3 + 5	54 = Pump 2 + 3 + 5 + 6
23 = Pump 1 + 2 + 3 + 5	55 = Pump 1 + 2 + 3 + 5 + 6
24 = Pump 4 + 5	56 = Pump 4 + 5 + 6
25 = Pump 1 + 4 + 5	57 = Pump 1 + 4 + 5 + 6
26 = Pump 2 + 4 + 5	58 = Pump 2 + 4 + 5 + 6
27 = Pump 1 + 2 + 4 + 5	59 = Pump 1 + 2 + 4 + 5 + 6
28 = Pump 3 + 4 + 5	60 = Pump 3 + 4 + 5 + 6
29 = Pump 1 + 3 + 4 + 5	61 = Pump 1 + 3 + 4 + 5 + 6
30 = Pump 2 + 3 + 4 + 5	62 = Pump 2 + 3 + 4 + 5 + 6
31 = Pump 1 + 2 + 3 + 4 + 5	63 = Pump 1 + 2 + 3 + 4 + 5
64 = Pump 7	128 = Pump 8
256 = Pump 9	512 = Pump 10

### *P193 Calib. Pumps*

This parameter is used to calibrate the pumps and determine the optimum (100%) efficiency of the pump from which all subsequent efficiency calculations will be derived. You can either choose to “calibrate” an individual pump or alternatively have each pump “calibrated” in turn automatically.

When selecting pumps to be calibrated individually (Option 1 to 5), it is essential that the level in the vessel is above the relevant pump start point to ensure correct calibration. Once you have selected the pump to be “calibrated” you will be prompted to return to the RUN mode, there will then be a delay before the pump starts which is equal to the **Calib. Delay (P188)** the display will show the time being counted down time to the pump start. Once the pump has started the display will show a countdown time equal to the **Cal. Duration (P189)**, calculation of pump efficiency will be complete on the expiry of the count and the unit will return to normal operation. If you choose to “calibrate” the pumps automatically (Option 7) then when the unit is returned to the RUN mode each pump will be “calibrated” in turn as and when it is next called to run.

### *Display Parameters*

#### *Options*

#### *P800 Display Units*

This parameter determines whether the reading displayed is in **Measurement Units (P104)**, or as a **percentage of span**.

OPTION	DESCRIPTION
<b>1 = Measured (Default)</b>	Display is in selected unit's dependent in Mode <b>(P100)</b>
2 = Percentage	Display is in <b>percentage</b> of span dependent in Mode <b>(P100)</b>

#### *P801 Decimal Places*

This parameter determines the number of decimal places on the reading during run mode.

Minimum = 0 (No decimal places), Maximum 3 = (3 decimal Places)

**Default = 2** (2 decimal Places).

*P802 Display Offset*

The value of this parameter is added to the reading before it is displayed, in **Measurement Units (P104)**.

It does not affect the relay setpoints or the mA output, only the reading on the display.

You could use this feature if for example you wanted to reference the reading to sea level, where you would enter the distance between **Empty Level (P105)** and sea level. If the empty level point is below sea level, then enter a negative value.

*P804 Display Conversion*

The reading is multiplied by the value of this parameter before being displayed. The default is 1.0, but if for example you wanted to display the reading in yards, then set the **Measurement Units (P104)** to feet and set **P804** to 3.

*P805 Display Source*

This parameter determines which input the display will relate to, it is automatically set to the correct option(s) when selecting the **Mode P100**.

OPTION	DESCRIPTION
<b>1 = Default (Default)</b>	Displays reading obtained from selected <b>Mode (P100)</b>
2 = Xducer1	Displays level from transducer 1
3 = Xducer 2	Displays level from transducer 2

## Failsafe

### P808 Failsafe Mode

By default, if a fail-safe condition occurs, then the display, relays and the mA output are held at their last **known** values until a valid reading is obtained.

If required, then you can change this so that the unit goes to **high** (100% of span), or **low** (empty) as follows:

OPTION	DESCRIPTION
<b>1 = Known (Default)</b>	Remain at its last <b>known</b> value
2 = High	Will fail to the <b>high</b> value (100% span)
3 = Low	Will fail to the <b>low</b> value (empty)

— See Also P218, P228, P238, P248, P258 - Relay Fail-safe and P840 mA Output Fail-safe

### Important Notice

In the event of a fail-safe condition occurring, the display, relays and mA Output can be configured to fail to a condition which is independent of each other. To set independent Relay Failsafe see P218, 228, 238, 248, 258, 268. And for independent mA Output Failsafe see P840.

### P809 Failsafe Time

In the event of a failsafe condition the failsafe timer determines the time before failsafe mode is activated. **Default = 2mins**

If the timer activates, the unit goes into **failsafe**, as determined by **P808 (Display), P218, 228, 238, 248, 258, 268 (Relays)** and **P840 (mA Output)**. When this happens, you will see the message "**Failed Safe!**" on the display, along with a message explaining why (lost echo or transducer fault, for example). When a valid measurement is obtained then the display, relays and mA output will be restored, and the timer is reset.

## Auxiliary

### P810 Units

This parameter determines whether the **Measurement units (P104)** are displayed on the auxiliary line of the display in run mode.

OPTION	DESCRIPTION
0 = No	Measurement units <b>will not</b> be displayed
<b>1 = Yes (Default)</b>	Measurement units <b>will</b> be displayed

### P811 Alarm Messages

This parameter determines whether notification messages are displayed on the auxiliary line of the display in run mode when an alarm relay is switched on or off. The message is in the form "Alarm High ON", where the 'High' is determined by the setting of the relay **Alarm ID (P212, 222, 232)**.

OPTION	DESCRIPTION
<b>0 = No (Default)</b>	Alarm messages <b>will not</b> be displayed
1 = Yes	Alarm messages <b>will</b> be displayed

### P812 General Control or Pump Messages

This parameter determines whether notification messages are displayed on the auxiliary line of the display in run mode when a pump or general control relay is switched on or off. The message is in the form "General 1 ON", where the number displayed is the number of the relay.

OPTION	DESCRIPTION
<b>0 = No (Default)</b>	Pump messages <b>will not</b> be displayed
1 = Yes	Pump messages <b>will</b> be displayed

### P813 Control Messages

This parameter determines whether notification messages are displayed on the auxiliary line of the display in run mode when a control relay is switched on or off. The message is in the form "Time ON".

OPTION	DESCRIPTION
<b>0 = No (Default)</b>	Control messages <b>will not</b> be displayed
1 = Yes	Control messages <b>will</b> be displayed



*P814 Miscellaneous Messages*

This parameter determines whether notification messages are displayed on the auxiliary line of the display in run mode when a miscellaneous relay is switched on or off. The message is in the form "Clock ON".

OPTION	DESCRIPTION
<b>0 = No (Default)</b>	Miscellaneous messages <b>will not</b> be displayed
1 = Yes	Miscellaneous messages <b>will</b> be displayed

*P815 Auxiliary Source*

This parameter determines whether the instantaneous velocity readings are displayed on the auxiliary line of the display in run mode.

OPTION	DESCRIPTION
<b>0 = Off (Default)</b>	Auxiliary display not used to display measurement readings.
2 = Xducer 1	Displays level from transducer 1
3 = Xducer 2	Displays level from transducer 2
4 = Rate	Displays Inflow (I) and pumping rate (P)

*P816 Totaliser (R)*

This parameter determines whether or not the resettable totaliser will be displayed in the auxiliary line of the display in run mode. When selected the auxiliary display will scroll between the resettable totaliser and the totaliser units selected. **Default = 0 (Off)**.

*P817 Auxiliary Offset*

The value of this parameter is added to the reading of the auxiliary display before it is displayed, in **Measurement Units (P104)**.

## **Totaliser**

### *P820 Totaliser*

Displays the current value of the, non-resettable totaliser. During run mode this totaliser can be viewed via the "Totaliser" hot key,  $\Sigma$ . Unlike the resettable totaliser this totaliser cannot be reset whilst in run mode, it can however be reset whilst in program mode by accessing **P820 Totaliser** and entering **zero**.

### *P821 Totaliser (R)*

Displays the current value of the, resettable totaliser. This **totaliser** can be allocated to appear, during **run mode**, on the auxiliary display line (**P816**) or alternatively via the "Totaliser" hot key.

### *P822 Totaliser Decimal Places*

This parameter determines the number of decimal places in the totaliser during run mode. It can be set between 1 and 3. **Default = 2**

*P823 Totaliser Multiplication Factor*

This parameter determines the number of decimal places in the totaliser during run mode. It can be set between 1 and 3. **Default = 2**

Use this parameter if the totaliser increments by too large or small amount, enter the factor by which the actual flow rate is multiplied by before incrementing the totaliser.

*Example:* If flowrate is being calculated and displayed in ltrs/second and it is desired to increment the totaliser in cubic metres select  $7 = *1000$ .

When viewing, the totaliser display will state, "Units are: L\*1000", and the totaliser will be incremented every 1000 litres. The options are:

OPTION	DESCRIPTION
1 = 1/1000	Totaliser will increment every 1/1000 <sup>th</sup> units of flow
2 = 1/100	Totaliser will increment every 1/100 <sup>th</sup> units of flow
3 = 1/10	Totaliser will increment every 1/10 <sup>th</sup> units of flow
<b>4 = *1 (Default)</b>	Totaliser will increment every 1 units of flow
5 = 10	Totaliser will increment every 10 units of flow
6 = 100	Totaliser will increment every 100 units of flow
7 = 1,000	Totaliser will increment every 1000 units of flow
8 = 10,000	Totaliser will increment every 10,000 units of flow
9 = 100,000	Totaliser will increment every 100,000 units of flow
10 = 1,000,000	Totaliser will increment every 1,000,000 units of flow

**Bargraph**

*P829 Bargraph*

By **default**, the bar graph will be representative of the reading obtained, as determined by the **Mode P100**. When **P100 = 4 (Average)** or **5 (Differential)** the bar graph can be assigned to be representative of the **level** on any of the two points of measurement. This parameter is automatically set to the correct default option when selecting the **Mode P100** and **Xducer (P101)**, and under normal circumstances will not require changing.

The options, dependant on the **value** entered for **Mode P100**, are as follows:

OPTION	DESCRIPTION
2 = Xducer 1 (Default)	Bargraph will be representative of levels obtained from <b>transducer 1</b>
3 = Xducer 2	Bargraph will be representative of levels obtained from <b>transducer 2</b>
4 = Avg. Level or Diff ½	Bargraph will be representative of the Avg. Level or Differential of two points of measurement, as selected in <b>Mode P100</b>

## ***mA Output 1 Parameters***

### ***Range***

#### *P830 mA Range*

This parameter determines the range of the mA output, from the following:

<b>OPTION</b>	<b>DESCRIPTION</b>
0 = Off	mA output disabled
1 = 0 to 20 mA	mA output directly proportional to the <b>mA mode (P831)</b> , so if the reading is 0% the output is 0 mA. If the reading is 100% the output is 20 mA.
<b>2 = 4 to 20 mA (Default)</b>	mA output directly proportional to the <b>mA mode (P831)</b> , so if the reading is 0% the output is 4 mA. If the reading is 100% the output is 20 mA.
3 = 20 to 0 mA	mA output inversely proportional to the <b>mA mode (P831)</b> , so if the reading is 0% the output is 20 mA. If the reading is 100% the output is 0 mA.
4 = 20 to 4 mA	mA output inversely proportional to the <b>mA mode (P831)</b> , so if the reading is 0% the output is 20 mA. If the reading is 100% the output is 4 mA.

## Operation

### P831 mA1 Mode

This parameter determines how the mA Output relates to what is measured. By **default**, it operates exactly the same as the display (**P100**), but it can be set to operate as follows:

OPTION	DESCRIPTION
<b>0 = Default</b>	mA output relative to <b>Mode P100</b>
1 = Distance	mA output relative to <b>Distance</b> .
2 = Level	mA output relative to <b>Level</b> .
3 = Space	mA output is relative to <b>Space</b> .
4 = Avg. Level	mA output relative to <b>Avg. Level</b> of two points of measurement. <b>P100 = 4</b>
5 = Differential	mA output is relative to the <b>differential</b> between two points of measurement. <b>P100 = 5</b>
6 = Pump rate	mA output is relative to the <b>pumping rate</b> (for RMA)

### Setpoint

By **default**, the mA Output will represent the **empty (0 or 4mA)** dependant on (**P830 mA Range**) and **100%** of the operational **span (20mA)**, but you may wish to have the output represent a section of the operational span. For example, the application has an operational span of 6 metres, but **output** is to **represent empty (0 or 4mA)** dependant on (**P830 mA Range**) to a **level of 5 metres (20mA)**. If so P834 (Low Level) should be set to 0.00 metres and P835 (High Level) should be set to 5 metres.

#### P834 mA1 Low Level

This parameter sets the level, distance, or space, depending on the selected **mA Out Mode (P831)** at which the low mA output will occur (**0 or 4mA** dependant on (**P830 mA Range**)). **Default = 0.000m**

#### P835 mA1 High Level

This parameter sets the level, distance or space, depending on the selected **mA Out Mode (P831)** at which the high mA output will occur (**20mA**). **Default = 6.00m**

## **mA1 Limits**

### *P836 mA1 Low Limit*

This parameter sets the lowest level that the mA output will drop to, the default is 0mA, but you can override this if the device you connect to cannot for example accept less than 2mA, yet you want to use the 0-20mA range.

**Default = 0.00mA**

### *P837 mA1 High Limit*

This parameter sets the highest level that the mA output will rise to, the default is 20 mA, but you can override this if the device you connect to cannot for example accept more than 18 mA, yet you want to use the 0-20 mA range. **Default = 20.00mA**

## **mA1 Trim**

### *P838 mA1 Low Trim*

If the device you are connected to is not calibrated, and not showing the correct **low value** (reading), then you can trim it using this parameter. You can either type in the offset directly or use the arrow keys to move the output up and down until you get the expected result (reading) on the device that is connected.

### *P839 mA1 High Trim*

If the device you are connected to is not calibrated, and not showing the correct **high value** (reading), then you can trim it using this parameter. You can either type in the offset directly or use the arrow keys to move the output up and down until you get the expected result (reading) on the device that is connected.

### **mA1 Failsafe**

#### *P840 mA Failsafe Mode*

This parameter determines what happens to the mA output in the event of the unit going into fail-safe mode. The **default** is to do the same as the **system fail-safe (P808)**, but this can be overridden to force the mA output to an independent fail-safe mode as follows:

OPTION	DESCRIPTION
<b>0 = Default</b>	mA output will fail as per <b>P808</b>
1 = Hold	mA output will retain its last known value.
2 = Low	mA output will fail to its <b>low</b> condition.
3 = High	mA output will fail to its <b>high</b> condition.

### **mA1 Allocation**

#### *P841 mA Allocation*

By default, the mA output will be representative of the reading obtained, as determined by the **Mode P100**. This parameter is automatically set to the correct default option when selecting the **Mode P100** and **Xducer (P101)**, and under normal circumstances will not require changing.

The options, dependant on the **value** entered for **Mode P100**, are as follows:

OPTION	DESCRIPTION
<b>2 = Xducer 1 (Default)</b>	mA output relates to transducer 1 <b>level</b> .
3 = Xducer 2	mA output relates to transducer 2 <b>level</b> .
4 = Avg. Level	mA output relates to the <b>average level</b> of two points of measurement. <b>P100 = 4</b>
5 = Differential 1/2	mA output relates to the <b>differential</b> level of two points of measurement. <b>P100 = 5</b>



## ***mA Output 2 Parameters***

### ***Range***

#### *P890 mA Range*

This parameter determines the range of the mA output, from the following:

<b>OPTION</b>	<b>DESCRIPTION</b>
0 = Off	mA output disabled
1 = 0 to 20 mA	mA output directly proportional to the <b>mA mode (P831)</b> , so if the reading is 0% the output is 0 mA. If the reading is 100% the output is 20 mA.
<b>2 = 4 to 20 mA (Default)</b>	mA output directly proportional to the <b>mA mode (P831)</b> , so if the reading is 0% the output is 4 mA. If the reading is 100% the output is 20 mA.
3 = 20 to 0 mA	mA output inversely proportional to the <b>mA mode (P831)</b> , so if the reading is 0% the output is 20 mA. If the reading is 100% the output is 0 mA.
4 = 20 to 4 mA	mA output inversely proportional to the <b>mA mode (P831)</b> , so if the reading is 0% the output is 20 mA. If the reading is 100% the output is 4 mA.

## Operation

### *P891 mA2 Mode*

This parameter determines how the mA Output relates to what is measured. By **default**, it operates the same as the display (**P100**), but it can be set to operate as follows:

OPTION	DESCRIPTION
<b>0 = Default</b>	mA output relative to <b>Mode P100</b>
1 = Distance	mA output relative to <b>Distance</b> .
2 = Level	mA output relative to <b>Level</b> .
3 = Space	mA output is relative to <b>Space</b> .
4 = Avg. Level	mA output relative to <b>Avg. Level</b> of two points of measurement. <b>P100 = 4</b>
5 = Differential	mA output is relative to the <b>differential</b> between two points of measurement. <b>P100 = 5</b>
6 = Pump rate	mA output is relative to the <b>pumping rate</b> (for RMA)

## Setpoint

By **default**, the mA Output will represent the **empty (0 or 4mA)** dependant on (**P830 mA Range**) and **100%** of the operational **span (20mA)**, but you may wish to have the output represent a section of the operational span. For example, the application has an operational span of 6 metres, but **output** is to **represent empty (0 or 4mA)** dependant on (**P830 mA Range**) to a **level of 5 metres (20mA)**. If so P834 (Low Level) should be set to 0.00 metres and P835 (High Level) should be set to 5 metres.

### *P892 mA2 Low Level*

This parameter sets the level, distance, or space, depending on the selected **mA Out Mode (P831)** at which the low mA output will occur (**0 or 4mA** dependant on (**P830 mA Range**)). **Default = 0.000m**

### *P893 mA2 High Level*

This parameter sets the level, distance or space, depending on the selected **mA Out Mode (P831)** at which the high mA output will occur (**20mA**). **Default = 6.00m**

## **mA2 Limits**

### *P894 mA2 Low Limit*

This parameter sets the lowest level that the mA output will drop to, the default is 0mA, but you can override this if the device you connect to cannot for example accept less than 2mA, yet you want to use the 0-20mA range.

**Default = 0.00mA**

### *P895 mA2 High Limit*

This parameter sets the highest level that the mA output will rise to, the default is 20 mA, but you can override this if the device you connect to cannot for example accept more than 18 mA, yet you want to use the 0-20 mA range. **Default = 20.00mA**

## **mA2 Trim**

### *P838 mA2 Low Trim*

If the device you are connected to is not calibrated, and not showing the correct **low value** (reading), then you can trim it using this parameter. You can either type in the offset directly or use the arrow keys to move the output up and down until you get the expected result (reading) on the device that is connected.

### *P839 mA2 High Trim*

If the device you are connected to is not calibrated, and not showing the correct **high value** (reading), then you can trim it using this parameter. You can either type in the offset directly or use the arrow keys to move the output up and down until you get the expected result (reading) on the device that is connected.

**mA2 Failsafe**

*P898 mA2 Failsafe Mode*

This parameter determines what happens to the mA output in the event of the unit going into fail-safe mode. The **default** is to do the same as the **system fail-safe (P808)**, but this can be overridden to force the mA output to an independent fail-safe mode as follows:

OPTION	DESCRIPTION
<b>0 = Default</b>	mA output will fail as per <b>P808</b>
1 = Hold	mA output will retain its last known value.
2 = Low	mA output will fail to its <b>low</b> condition.
3 = High	mA output will fail to its <b>high</b> condition.

**mA2 Allocation**

*P899 mA2 Allocation*

By default, the mA output will be representative of the reading obtained, as determined by the **Mode P100**. This parameter is automatically set to the correct default option when selecting the **Mode P100** and **Xducer (P101)**, and under normal circumstances will not require changing.

The options, dependant on the **value** entered for **Mode P100**, are as follows:

OPTION	DESCRIPTION
<b>2 = Xducer 1 (Default)</b>	mA output relates to transducer 1 <b>level</b> .
3 = Xducer 2	mA output relates to transducer 2 <b>level</b> .
4 = Avg. Level	mA output relates to the <b>average level</b> of two points of measurement. <b>P100 = 4</b>
5 = Differential 1/2	mA output relates to the <b>differential</b> level of two points of measurement. <b>P100 = 5</b>

## Compensation Parameters

### Offset

#### *P851 Measurement Offset*

The value of this parameter is added to the measured distance, in **Measurement Units (P104)**.

This Offset will be added to the level, as derived from the transducer, and will affect everything including the reading on the display, the relay setpoints and the mA output.

### Temperature

#### *P852 Temperature Source*

This parameter determines the source of the temperature measurement. By **default**, it is set to automatic (**P852=1**), which will automatically detect if a temperature sensor is available from the transducer. If for any reason, no temperature input is received, then the **Fixed Temp** value is used, as set by **P854**.

The temperature source can be specifically set as follows:

OPTION	DESCRIPTION
1 = Automatic	Will automatically select transducer temperature sensor, if available, or fixed temperature (P854) if no temperature sensor found.
2 = Xducer	Always uses temperature reading from transducer.
3 = Fixed	Always uses fixed temperature (P854)
<b>4 = Ext Range "A" (Default)</b>	Uses an optional external temperature sensor with an operating range of -25°C to 50°C.
5 = Ext Range "B"	Uses an optional external temperature sensor with an operating range of -25°C to 125°C.

#### *P854 Fixed Temperature*

This parameter sets the temperature, in degrees centigrade to be used if **P852 (Temperature Source) =3**. **Default = 20°C**.

*P853 Allocation*

This parameter allows the temperature reading to be allocated to either transducer when **Mode P100 = 4 (Avg. Level)** or **5 (Diff Level)** and **P101 = Xducer**.

OPTION	DESCRIPTION
<b>0 = Xducer 1 (Default)</b>	Temperature reading will be obtained from transducer 1
1 = Xducer 2	Temperature reading will be obtained from transducer 2

*P854 Fixed Temperature*

This parameter sets the temperature, in degrees centigrade to be used if **P852 (Temperature Source) =3. Default = 20°C.**

**OVF Persist**

*P865 OVF Count*

This parameter determines the number of consecutive cycles that the overflow condition or the rest condition must be present for, before the OVF alarm changes state.

**Velocity**

*P860 Sound Velocity*

This parameter allows for the velocity of sound to be changed according to the atmosphere the transducer is operating in. By default, the velocity is set for sound travelling in air at an ambient temperature of 20 degrees centigrade (at 1bar, atmospheric pressure). **Default = 342.72 m/sec.**

## Stability Parameters

### Damping

Damping is used to damp the display, to enable it to keep up with the process but ignore minor surface fluctuations.

#### *P870 Fill Damping*

This parameter determines the **maximum rate** at which the unit will respond to an **increase in level**. It should be set slightly higher than the maximum vessel fill rate. **Default = 10m/min.**

#### *P871 Empty Damping*

This parameter determines the **maximum rate** at which the unit will respond to a **decrease in level**. It should be set slightly higher than the maximum vessel empty rate. **Default = 10m/min.**

### Indicator

#### *P872 Fill Indicator*

This parameter determines the rate at which the LCD **fill** indicator activates. **Default = 10m/min.**

#### *P873 Empty Indicator*

This parameter determines the rate at which the LCD **empty** indicator activates. **10m/min.**

### Rate

#### *P874 Rate Update*

This parameter determines the way in which the rate is calculated. If set to **continuous (P874=0)**, then the rate is calculated and displayed continuously, i.e. any change seen from shot to shot is calculated and displayed, but if set to use **values P874=1(Default)** then the **values** set in **P875** and **P876** are used to calculate and display the rate.

#### *P875 Rate Time*

This parameter is the period (in seconds) over which the material level rate of change is averaged before the **Rate Value (P877)** is updated. If the **Rate Distance (P876)** is exceeded before the **Rate Time (P875)** has expired, then the **Rate Value (P877)** will be updated immediately. **Default = 60sec.**

### *P876 Rate Distance*

This parameter is the rate **Measurement Units (P104)** over which the material level must change before the **Rate Value (P877)** is updated. If the **Rate Time (P875)** expires before the **Rate Distance (P876)** is exceeded, then the **Rate Value (P877)** will be updated immediately. **Default = 0.05m**

### *P877 Rate Value*

This parameter displays the current rate of change of material level, in **Measurement Units (P104)** per minute. It is read only.

### *P878 Lower Cutoff*

This parameter is used to select the minimum Rate to be calculated and can be used to eliminate unwanted updates from effects of ripples/waves on the surface of the material.

## **Filters**

The following three parameters can be used to filter out unwanted changes of level caused by a 'rippled' or agitated surface.

### *P880 Gate Mode*

This parameter determines the operation of the gate, which is established around the processed echo and is used to track the echoes movement and update the display. If set to **Fixed**, P880 = 0 (**Default**) then the width of the gate is determined by the value of **P881 Fixed Distance**. When set to **Calculated**, P880=1 then the gate width is automatically calculated and **updated** according to the values of **P870, P871, P874, P875 and P876**. Please consult Pulsar for further information and assistance on changing the value of this parameter.

### *P881 Fixed Distance*

This parameter determines the width of gate to be used in tracking an echo and under normal circumstances will not require changing, but it can be increased in the cases where the surface is moving extremely fast (in excess of 10m/min) to ensure smooth processing of the changing level.



### *P882 Process Filter*

This parameter determines the number of 'cycles' that will be taken before a change in level is processed and the display updated.

OPTION	DESCRIPTION
1 = Fast	level will be updated every cycle
2 = Medium	level will be updated every 8 cycles
<b>3 = Slow (Default)</b>	level will be updated every 16 cycles

### *P884 Peak Percentage*

This parameter is used if you choose a solids application, **P102 Material = 2 (Solids)**, where there maybe angles of repose on the material, and can be used to determine where in the returned echo the displayed level is.

**Default = 50%**

### *Echo Processing Parameters*

#### *Transducer 1 Status*

##### *P900 Transducer 1 Status*

This parameter shows the current state of the transducer. The value means the following:

OPTION	DESCRIPTION
0= OK	Transducer working correctly.
1= Disabled	Transducer is not being used (mA input is being used instead, so P101=1)
2= Stuck High	Indicates that the power and signal lines on the transducer terminals are crossed over, or the signal line is shorted to earth.
3= Not Found	No transducer is detected.

##### *P901 Echo Confidence 1*

This parameter displays the most recent echo confidence from the transducer. It is useful to help find the best mounting location for the transducer, where you should aim to get the highest figure. It is a percentage of confidence that the echo reporting the level is the correct one.

### *P902 Echo Strength 1*

This parameter displays the most recent echo strength figure for the transducer, where a higher figure indicates a better returned echo.

### *P903 Average Noise 1*

This is the mean noise reading for the transducer. It is measured while the transducer is not firing and gives an indication of the average amount of electrical noise present on the cabling.

### *P904 Peak Noise 1*

This is the peak noise reading for the transducer. It is measured while the transducer is not firing and gives an indication of the maximum amount of electrical noise present on the cabling.

### *P905 Sensitivity*

This parameter determines the sensitivity of the unit. Please consult Pulsar for further information and assistance on changing the value of this parameter.

### *P906 Side Clearance*

This parameter is used to set the distance by which the DATEM trace will "stand-off" from around unwanted echoes such as obstructions. Please consult Pulsar for further information and assistance on changing the value of this parameter.

## ***Transducer 2 Status***

### *P910 – P916 Transducer 2*

When Mode (P100) = 4 (Average Level) or 5 (Differential). These parameters contain the same information as detailed in Transducer 1 Status, but for transducer 2.

## ***DATEM Parameters***

The following two parameters are used to make changes to the DATEM trace such as setting it to its default value or using it to select a particular echo, both parameters are accessed directly by simply entering **Program Mode** then typing in the **parameter number** and pressing **ENTER**.

### *P020 Set DATEM 1*

This parameter allows DATEM to be reset to its default value or alternatively allows the user to "Capture" a DATEM trace. It should be noted that when using option 1 = Capture, all echoes seen will be eliminated by DATEM.

<b>OPTION</b>	<b>DESCRIPTION</b>
0 = Quit	Exit without any change to the present DATEM trace.
1 = Capture	DATEM trace of entire visible range taken and all echo returns referenced out.
2 = Default	DATEM trace will assume its default value
3 = Def Reset	Default DATEM to factory settings.
4 = Set Min DATEM	When set, DATEM levels at this point will be accepted as a minimum.

### *P021 Set Distance 1*

Allows the user or service personnel to determine which echo is to be displayed. On start up, if the unit displays an incorrect reading then simply enter the distance from the transducer to the required level and, if an echo is present at this point, the Gate will establish itself around the chosen echo, DATEM will update in front of the Gate and reference out any other unwanted echoes.

It should be noted that DATEM will reset to default values whilst performing this function, and reform itself once it has selected an echo.

#### **Important Notice**

**Enter the distance measurement from the face of transducer to the target, in units of measurement (P104) and press ENTER.**

## System Parameters

### Passcode

#### *P921 Enable Code*

**Enables** the passcode (**P922**), which means the passcode must be entered to go into program mode. If **disabled** (set to **0**), then no passcode is required, and ENTER is used to enter program mode. **Default = 1 (Enabled)**

#### *P922 Passcode*

This is the passcode that must be used to enter program mode. The **default** is **1997**, but this can be changed to another value from 0 to 9999.

### Backup

#### *P925 Parameter Backup & Restore*

This parameter is used to make a backup of all parameters, for example to ensure a default set is maintained within the unit. If alterations are made to the parameters that do not work as intended, then the backup set can be restored into the unit.

You can make two separate backup copies if you wish, called backup 1 and backup 2, and restore from either. The options are:

OPTION	DESCRIPTION
1= Backup 1	Make backup to area 1 of all parameters
2= Backup 2	Make backup to area 2 of all parameters
3= Restore 1	Restore all parameters from area 1
4= Restore 2	Restore all parameters from area 2

## System Information

*The following three parameters do not affect how the unit performs, but details, contained in them, may be required, by Pulsar, when making technical enquiries.*

#### *P926 Software Revision*

This parameter will display the current software revision. It is read only and cannot be changed.

### *P927 Hardware Revision*

This parameter will display the current hardware revision. It is read only and cannot be changed.

### *P928 Serial Number*

This parameter will display the serial number of the unit. It is read only and cannot be changed.

### *P929 Site Identification*

This parameter allows you to give each unit an individual reference number, for identification purposes. You can set any number between 1 and 99999.

### *P930 Factory Defaults*

This parameter resets all parameter values to the original Factory Set values that were installed when the unit was tested before despatch to you.

To reset parameters, enter **1 (Yes)**, and press ENTER, then you will see a message "Entr if sure", you should press ENTER again. If you press any other key at this point, the parameters will not be reset, and you will see a message confirming this.

Once you have done this, program the unit, to the desired application.

## **Date & Time**

The date and time is used, to control specific relay functions and date stamp certain events that are contained in the Data Logs. It is also used in conjunction with the system watchdog that keeps an eye on the times the unit has started.

### *P931 Date*

This parameter displays the **current date**, in the format as set by **P933 (Date Format)** and can be reset if required.

### *P932 Time*

This parameter displays the **current time** and can be reset if required, in the format HH: MM (24-hour format). This is set initially at the factory for UK time.

### *P933 Date Format*

This parameter allows you to alter the format that the date is displayed to your choice of DD: MM: YY, MM: DD: YY or YY: MM: DD. The default is DD: MM: YY.

## **LED Colour**

Each relay has an associated LED, located on the unit's front panel, which indicates the status of the relay. By default, the LED of any relay that has been programmed but is in its "OFF" state will be illuminated 'yellow'. When "ON" **alarm** relays will cause the **LED** to illuminate **Red** and **pump, control** and **miscellaneous** relays will cause the **LED** to illuminate **green**. LED's of any relays that have not been programmed will not be illuminated. Customised settings for the colour of LED's can be achieved by using the following parameters.

### *P935 Off Relay Colour*

This parameter selects the colour that a **programmed relay** should be when it is in its "OFF" state. The **default** is **3 = yellow**, but can be changed to 'no colour', red or green.

### *P936 Alarm Relay Colour*

This parameter selects the colour that an **alarm** relay should be when it is in its "ON" state. The **default** is **1 = red**, but can be changed to 'no colour', green or yellow.

### *P937 Pump Relay Colour*

This parameter selects the colour that a **pump** relay should be when it is in its "ON" state. The **default is 2 = green**, but can be changed to 'no colour', red or yellow.

### *P938 Control Relay Colour*

This parameter selects the colour that a **control** relay should be when it is in its "ON" state. The **default is 2 = green**, but can be changed to 'no colour', red or yellow.

### *P939 Miscellaneous Relay Colour*

This parameter selects the colour that a **miscellaneous** relay should be when it is in its "ON" state. The default is **2 = green**, but can be changed to 'no colour', red or yellow.

All relays that are not programmed will show, 'no colour', i.e. they are off.

#### **Important Notice**

When a relay has been failed, due to a fail signal having been received on its associated digital input, the relay LED will flash on and off, between yellow and red, to indicate that the relay has been failed but not put out of service. After the maximum attempts P300 have been made to start the device relay and it is put out of service then the relay LED will remain lit on red until such time that the input is reset.

### **Watchdog**

You can check how many times the unit has been switched on and look at the date and time of the last ten starts. This can be useful if there have been power failures or if for any reason the Quantum<sup>2</sup> restarts due to a fault condition. The Quantum<sup>2</sup> can be backed up from a battery which automatically cuts in during power failure, battery backed up units will continue uninterrupted operation and therefore will not register a loss of mains power. If, however the battery was to fail during a mains power interruption, a start-up would be recorded once power has been restored.

The following parameters can be accessed by directly entering the parameter number. To do this, enter the **program mode** and then **type** in the appropriate **parameter number**.

### *P940 Number of Starts*

This parameter shows how many times the unit has been powered up.

### *P941-P960 Start Date & Time*

Parameters **P941** and **P942** show the **date** and **time** that the unit was last started. There are **ten start dates & times** recorded, which are parameters **P943-P960**. The first on the list are the most recent, and the last ones are the oldest. These are read only and cannot be changed.

### *Daylight Saving Time*

#### **Important Notice**

In order to ensure the correct operation of Daylight Saving Time P932 Time should be checked, and adjusted if necessary, to ensure that it is set for the current valid time.

### *P970 DST Enable*

When **Enabled** (set to **1**) the internal clock will be automatically adjusted to compensate for the difference between standard time and **Daylight-Saving Time**. **Default = 1 (Yes)**

### *P971 DST Difference*

This parameter sets the time difference between standard time and **Daylight-Saving Time**. The time difference is entered in HH:MM. **Default = 01:00**

### *P972 DST Start Time*

This parameter is used to set the **time** of day at which **Daylight-Saving Time** will **start**, the time is entered in the format HH: MM (24-hour format). **Default = 02:00**



*P973 Start Day*

Use this parameter to enter the **day** of the week (**P974**) that **Daylight Saving Time** is to **start**.

OPTION	DESCRIPTION
2= Monday	DST will <b>start</b> on a <b>Monday</b>
3= Tuesday	DST will <b>start</b> on a <b>Tuesday</b>
4= Wednesday	DST will <b>start</b> on a <b>Wednesday</b>
5= Thursday	DST will <b>start</b> on a <b>Thursday</b>
6= Friday	DST will <b>start</b> on a <b>Friday</b>
7= Saturday	DST will <b>start</b> on a <b>Saturday</b>
<b>8= Sunday (Default)</b>	DST will <b>start</b> on a <b>Sunday</b>

*P974 Start Week*

This parameter will determine the **week** of the month (**P975**) in which **Daylight-Saving Time** is to **start**.

OPTION	DESCRIPTION
1= Week 1	DST will <b>start</b> on <b>day (P973)</b> in the <b>first</b> week ( <b>P974</b> ) of the <b>month (P975)</b> .
2= Week 2	DST will <b>start</b> on <b>day (P973)</b> in the <b>second</b> week ( <b>P974</b> ) of the <b>month (P975)</b> .
3= Week 3	DST will <b>start</b> on <b>day (P973)</b> in the <b>third</b> week ( <b>P974</b> ) of the <b>month (P975)</b> .
4= Week 4	DST will <b>start</b> on <b>day (P973)</b> in the <b>fourth</b> week ( <b>P974</b> ) of the <b>month (P975)</b> .
<b>5= Last (Default)</b>	DST will <b>start</b> on <b>day (P973)</b> in the <b>last</b> week ( <b>P974</b> ) of the <b>month (P975)</b> .

*P975 Start Month*

This parameter is used to select the **month**, in which **Daylight-Saving Time** will **start**.

OPTION	DESCRIPTION
1= January	<b>DST will start</b> during the month of <b>January</b>
2= February	<b>DST will start</b> during the month of <b>February</b>
<b>3= March (Default)</b>	<b>DST will start</b> during the month of <b>March</b>
4= April	<b>DST will start</b> during the month of <b>April</b>
5= May	<b>DST will start</b> during the month of <b>May</b>
6= June	<b>DST will start</b> during the month of <b>June</b>
7= July	<b>DST will start</b> during the month of <b>July</b>
8= August	<b>DST will start</b> during the month of <b>August</b>
9= September	<b>DST will start</b> during the month of <b>September</b>
10= October	<b>DST will start</b> during the month of <b>October</b>
11= November	<b>DST will start</b> during the month of <b>November</b>
12= December	<b>DST will start</b> during the month of <b>December</b>

*P976 DST End Time*

This parameter is used to set the **time** of day at which **Daylight-Saving Time** will **end**, the time is entered in the format HH: MM (24-hour format). **Default = 02:00.**

*P977 DST End Day*

Use this parameter to enter the **day** of the week (**P974**) that **Daylight Saving Time** is to **end**.

OPTION	DESCRIPTION
2= Monday	DST will <b>end</b> on a <b>Monday</b>
3= Tuesday	DST will <b>end</b> on a <b>Tuesday</b>
4= Wednesday	DST will <b>end</b> on a <b>Wednesday</b>
5= Thursday	DST will <b>end</b> on a <b>Thursday</b>
6= Friday	DST will <b>end</b> on a <b>Friday</b>
7= Saturday	DST will <b>end</b> on a <b>Saturday</b>
<b>8 = Sunday (Default)</b>	DST will <b>end</b> on a <b>Sunday</b>

*P978 End Week*

This parameter will determine the **week** of the month (**P975**) in which **Daylight-Saving Time** is to end.

OPTION	DESCRIPTION
1= Week 1	DST will <b>end</b> on <b>day (P973)</b> in the <b>first</b> week ( <b>P974</b> ) of the <b>month (P975)</b> .
2= Week 2	DST will <b>end</b> on <b>day (P973)</b> in the <b>second</b> week ( <b>P974</b> ) of the <b>month (P975)</b> .
3= Week 3	DST will <b>end</b> on <b>day (P973)</b> in the <b>third</b> week ( <b>P974</b> ) of the <b>month (P975)</b> .
4= Week 4	DST will <b>end</b> on <b>day (P973)</b> in the <b>fourth</b> week ( <b>P974</b> ) of the <b>month (P975)</b> .
<b>5= Last (Default)</b>	DST will <b>end</b> on <b>day (P973)</b> in the <b>last</b> week ( <b>P974</b> ) of the <b>month (P975)</b> .

*P979 End Month*

This parameter is used to select the **month**, in which **Daylight-Saving Time** will **end**.

OPTION	DESCRIPTION
1= January	<b>DST will end</b> during the month of <b>January</b>
2= February	<b>DST will end</b> during the month of <b>February</b>
3= March	<b>DST will end</b> during the month of <b>March</b>
4= April	<b>DST will end</b> during the month of <b>April</b>
5= May	<b>DST will end</b> during the month of <b>May</b>
6= June	<b>DST will end</b> during the month of <b>June</b>
7= July	<b>DST will end</b> during the month of <b>July</b>
8= August	<b>DST will end</b> during the month of <b>August</b>
9= September	<b>DST will end</b> during the month of <b>September</b>
<b>10= October (Default)</b>	<b>DST will end</b> during the month of <b>October</b>
11= November	<b>DST will end</b> during the month of <b>November</b>
12= December	<b>DST will end</b> during the month of <b>December</b>

*Device Comm.*

*RS232 Set Up*

*P061 Comms Baud*

This parameter is used to set the speed (Baud Rate) of the RS232 communications and can be changed to suit the connecting device.

**Default = 19200**

*RS 485 Set Up*

Please refer to the RS485 communications manual for availability of parameters and details of their options. This can be found in the downloads section of the Pulsar website:

<https://pulsarmeasurement.com/downloads/instruction-manuals/>

### Remote Alarm

When a Modem is connected, via the RS232 port, (Consult Pulsar or your local distributor for further details), the following parameters are used to set up the Quantum<sup>2</sup> so that when the level reaches a specific alarm point, as determined by the setting of the relay(s) the unit will dial and connect to a remote telephone number to provide details of the event.

#### P144 Call Type

This parameter determines what type of connection is made via the modem.

OPTION	DESCRIPTION
<b>0 = Off (Default)</b>	Remote alarm function is disabled
1 = Ring	This option initiates a connection to a remote modem/computer which will then allow remote communication with the unit. Please consult Pulsar or your local distributor for further details.
2 = SMS	This option initiates a predetermined message which is sent to the remote telephone number detailing date and time the alarm was initiated, the site ID, alarm condition and level at the time the alarm was initiated.

#### P145 Tel. No.1

This parameter is used to enter the number of '0's that appear at the beginning of the telephone number to be dialled to receive the message.

OPTION	DESCRIPTION
0= None	No '0's present at the beginning of the telephone number to be dialled.
<b>1 = Add 0 (Default)</b>	1 '0' present at the beginning of the telephone number to be dialled.
2= Add 00	2 '0's present at the beginning of the telephone number to be dialled.

*P146 Tel. No2*

This parameter is used to enter the next 6 digits, following the '0's, of the telephone number to be dialled. If there are less than 6 digits following the '0's, then just enter the digits required, if there are more than 6 digits following the '0's then enter the first 6 digits and then proceed to P147 to enter the remainder.

*P147 Tel. No3*

This parameter is used to enter any remaining digits of the telephone number to be dialled after completion of P145 and P146 above.

**Example**

Telephone number to be dialled is: 0 1234 123456

P145 Tel. No. 1 = 1 (One '0' at the beginning of the telephone number)

P146 Tel. No. 2 = 123412 (The next 6 digits following the '0's).

P147 Tel. No. 3 = 3456 (Remaining digits of telephone number).

*P148 Timed Out*

This parameter will set the time period that the unit will wait for a reply before disconnecting.

**Default = 90 seconds**

*P149 Retry No.*

This parameter will set the number of times the telephone number will be re-dialled if no reply is received. If set to '0' then the number will be re-dialled continually until a reply is received, if set to '-1' then the number will not be re-dialled at all. Any other value entered between 1 and 99 will determine the number of re-dials to be attempted.

**Default = 0**

## Test Parameters

### Simulation

#### *P980 Simulate*

Test mode is used to simulate the application and confirm that all parameters and relay setpoints have been entered as expected. During simulation, there is a choice of whether the relays will change state (hard simulation) or not (soft simulation), but the LED's will always change colour as programmed, and the current output will change. If you want to test the logic of the system that the relays are connected to then select a hard simulation, but if you do not want to change the relay state, then select a soft simulation.

There are two simulation modes, **automatic** and **manual**. Automatic simulation will move the level up and down between empty level or the pre-determined **Start Level (P983)** and Pump/Control relay switch points, if you wish to change the direction of the level movement e.g. to go beyond relay setpoints, this can be done by using the arrow keys. In manual simulation, using the arrow keys will allow you to move the level up and down as required.

The choices for you to enter are as follows.

- 1= Manual soft simulation
- 2= Automatic soft simulation
- 3= Manual hard simulation
- 4= Automatic hard simulation

Whilst in Automatic hard simulation (**P980 = 4**) the switching of digital inputs can be simulated by pressing the corresponding numeric key to the input to be switched, each time the numeric key is pressed it will toggle the input between On and Off.

To return to program mode, press 'CANCEL' and test mode will end.

### Important Notice

**Pump start delay (which by default is 10 seconds) is set to 0 during simulation.**

### *P981 Increment*

By **default**, simulation mode will move by **0.1m** steps in manual simulation and by **0.1m/min** in automatic simulation. Altering the increment can change this value.

### *P982 Rate*

In automatic mode, the rate at which the level will move up and down, is determined by distance, **P981 Increment** and the time, **P982 Rate** which by **default** is set to **1min** and can be changed as required. To increase the rate at which the level moves increase the **Increment (P981)** or decrease the **Rate (P982)**. To decrease the rate at which the level moves decrease the **Increment (P981)** or increase the **Rate (P982)**.

### *P983 Start Level*

When using automatic simulation this parameter can be used to pre-determine the point at which the simulated level will start at and return to. This can be used to simulate the lowest point to which the level would normally operate.

### *P984 Inc. Change*

When using automatic simulation, you can incrementally increase or decrease the rate whilst running simulation. The rate is increased /decreased incrementally by the value **P984 (Incremental Change)** by using the "**decimal point**" key to **increase** and the "**plus/minus**" key to **decrease** the rate of change.

**Default = 0.1m**

## **Hardware**

### *P990 Self Test*

If you enter 1 for this parameter, then the unit will perform a self-test. This will confirm that the various parts of the circuitry are working correctly. You will see confirmation messages that the clock and the EEPROM are working correctly, and error messages for any parts that fail.



### *P991 Hard Test*

When this parameter is selected, the unit will test the following in turn.

- **LED's.** Watch them change colour as shown on the display, and press, ENTER, if they operated as shown.
- **Relays.** Press a numeric key corresponding to the number of the relay you wish to test, and the relay will change state each time the key is pressed. If you press any other key, other than a valid relay number, then the test will end.
- **Segments.** All the segments on the LCD are lit up, so you can see if they all work. Press, ENTER, to end the test. The LED's all go green at the same time.
- **Keys.** You should press each key, to confirm it works, with a counter showing how many more keys you have to press. Be sure to press the **CANCEL** key last, as this will show if all keys were pressed or not. If they were not, then an error message is displayed.

### *P992 mA Out Test*

This parameter will allow you to force a specified current on the mA output, to test the equipment that it is connected to, and to make sure the unit is working correctly. The figure you enter will be generated by the mA output.

### *P993 mA In Test*

This parameter will allow you to test the mA input, by injecting a known mA signal from an external source you can check the unit is working correctly and as expected.

### *P994 Transducer Test*

If you enter 1 for this parameter it will continually fire the transducer, so you can check the wiring, until you press any key to cancel.

### *P995 Keys Test*

You should press each key, to confirm it works, with a counter showing how many more keys you have to press. Press the **CANCEL** key last, as this will confirm if all keys were pressed or not. If they were not, then an error message is displayed.

*P996 Relay Test*

Press a numeric key corresponding to the number of the relay you wish to test, and the relay will change state each time the key is pressed. If you press any other key, other than a valid relay number, then the test will end.

## CHAPTER 6 TROUBLESHOOTING

This section describes many common symptoms, with suggestions as to what to do. If the issue persists, please contact your local Pulsar distributor.

SYMPTOM	WHAT TO DO
Display blank, transducer not firing.	Check power supply, voltage selector switch and fuse.
Displays "No Xducer"	Check wiring to transducer.
Displays "Xducer Flt"	There is a fault with the transducer wiring, so check wiring to transducer.
Displays 'Failed Safe'	The transducer has not been able to lock on to a target. Check transducer wiring, check P900 status. Check to see if transducer is 'clicking', check for any obstructions in the application.
Incorrect reading being displayed for current level.	Measure actual distance from transducer head to surface of material. Enter Program Mode and directly access P21 (Set Distance) type in the measured distance, ENTER, ENTER again when prompted, wait until SET displayed and return to Run Mode, display should now update to correct reading.
Material level is consistently incorrect by the same amount.	Check empty level, (P105) display offset, (P802) and measurement offset (P851).
LED's change colour at relevant relay switch points but relays do not change state.	Check supply to unit and ensure voltage selector set to correct position.

## CHAPTER 7 DISPOSAL

Incorrect disposal can cause adverse effects to the environment.

Dispose of the device components and packaging material in accordance with regional environmental regulations including regulations for electrical \ electronic products.

### Transducers

Remove power, disconnect the Transducer, cut off the electrical cable and dispose of cable and Transducer in accordance with regional environmental regulations for electrical \ electronic products.

### Controllers

Remove power, disconnect the Controller and remove battery (if fitted).  
Dispose of Controller in accordance with regional environmental regulations for electrical \ electronic products.

Dispose of batteries in accordance with regional environmental regulations for batteries.



 EU WEEE Directive Logo

This symbol indicates the requirements of Directive 2012/19/EU regarding the treatment and disposal of waste from electric and electronic equipment.

## NOTES



**[www.pulsarmeasurement.com](http://www.pulsarmeasurement.com)**

**SUPPORT@PULSARMEASUREMENT.COM**

*Copyright © 2020 Pulsar Measurement Ltd.*

*Registered Address: 1 Chamberlain Square CS, Birmingham B3 3AX*

*Registered No.: 3345604 England & Wales*

*Rev 1.0*