

Small Series Flow Rate Indicator



Manufacturer of Specialist Flow Instruments

Function

The small series units are designed to be robust, highly versatile and extremely reliable in the harshest of environments. They continuously monitor flow with a local indication, through a mechanical pointer, switch, transmitter or digital rate totaliser and can be manufactured in a variety of materials to suit a wide range of liquid, air and gas applications.

Maximum Flow Rates

3/4" - 1 1/2" 0 - 400 l/min
 1 1/2" - 2" 0 - 500 l/min
 2 1/2" - 2" 0 - 800 l/min

Maximum Pressure

Low pressure up to 300psi (20 Bar)
 Medium pressure up to 725psi (50 Bar)
 High pressure up to 300psi (200 Bar)*

NB: Minimum scale 0 - 40 l/min *Cast iron, steel and stainless steel only

Design

This unique modular design allows for easy field installation and service. No straight run of pipe is required before or after the monitor minimizing pressure drop and the installation footprint. Vane-style flow meters have a spring-opposed vane that moves in relation to the flow rate. The fluid forces the vane to move through a contoured opening creating a variable orifice, the greater the flow the larger the orifice becomes for flow to pass. The vane style monitor is spring loaded and allows the vane to return on decreasing flows.

Benefits

- +/- 3% accuracy across full range
- Calibrated in any unit of measure
- Single or dual scale options
- Individually calibrated
- Simple modular design
- Low pressure drop
- Viscosities up to 600cSt
- 1% rate of repeatability switch set point – accurate & reliable
- Installed in any position
- Weatherproof enclosure box
- Capable of twice the maximum indicated flow
- Available in a wide range of materials

Applications

Water	De-Ionised Water	Soluble Oils (Glycols)
Petroleum Based Fluids	Synthetic Based Fluids	Coolants
Corrosive Fluids	Paints	Solvents
Air & Gases		

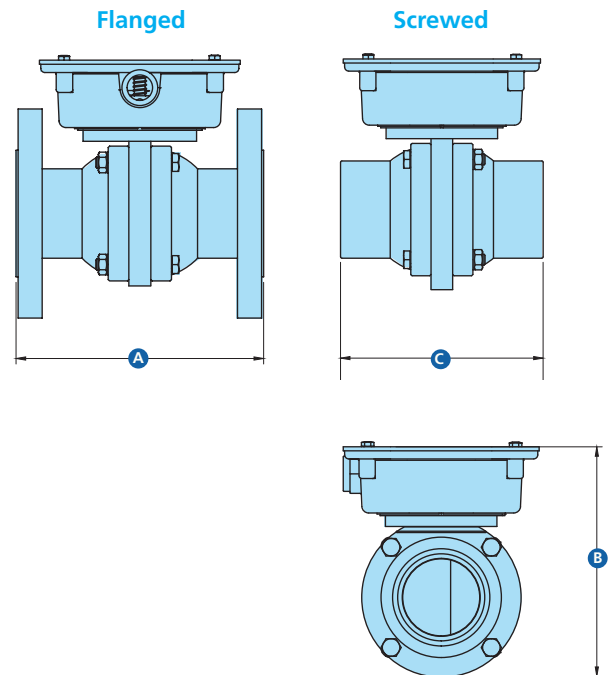
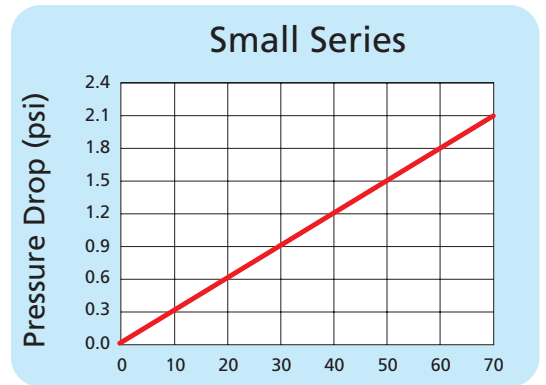

Min Full Scale	Max Full Scale	Pipe Size	Dimensions (mm)			Weight (kg)				
			a	b	c	AL	B	Cl	S/SS	PVC
LPM	LPM									
4	70	1/4 - 1"	160	150	130	1	2	2	2	1

PART CODE BUILDER

SERIES AND FLOW RATE





FMC*	= Low Flow
FML*	= Litres/Min
FMB*	= Imp. Gallons/Min
FMG*	= U.S. Gallons/Min
FMM*	= m ³ /Hour

* Add Full Flow Rate in Units

MATERIAL OF MANUFACTURE

AL	= Aluminium	* Only available up to 4" port connections and 100 psi / 7 bar maximum pressure. Note: For materials and pressures not specified, please consult factory
B	= Bronze	
CI	= Cast Iron	
CIK	= Cast Iron Nickel Plated	
S	= Carbon Steel	
SS	= Stainless Steel	
PTFE*	= PTFE	
PVC*	= PVC	

FLOW DIRECTIONS

D1	= 	D2	= 
D3	= 	D4	= 

'O' RING SEAL MATERIAL

S1	= Buna	(-40°C	+110°C)
S2	= EPDM	(-40°C	+150°C)
S3	= Viton	(-20°C	+200°C)
S4	= PTFE	(-100°C	+250°C)
S5	= Perlast	(-15°C	+330°C)

PRESSURE RATING

LP	= 300psi / 20 bar maximum
MP	= 750 psi / 50 bar maximum
HP	= 3000 psi / 200 bar maximum*

* CI, CIK, S & SS only

FML40 **SS** **LP** **3EE** **1cS** **4F150** **S3** **D1**

Example Parts List

INDICATOR READ OUT

ME	= Mechanical Pointer only
3EE	= SPDT 3 Wire Switch
3EEG	= SPDT 3 Wire Switch with Gold Contacts
4EE	= single-pole, double throw, double-break
6EE	= DPDT 6 Wire Switch
3EE(ATEX2)	= SPDT Explosion Proof Micro Switch to ATEX zone 2
3EE(ATEX1)	= SPDT Explosion Proof Switch to ATEX zone 1
6EE(ATEX1)	= DPDT Explosion Proof Switch to ATEX zone 1
AIR	= Pneumatic Switch
POT	= Potentiometer (specify rating)
OUT	= 4-20 mA Output
OUTX	= 4-20 mA (ATEX)
TOT	= Digital Rate Totaliser
TOTX	= Digital Rate Totaliser (ATEX)

Note 1: All electrical boxes (apart from TOT & TOTX) also carry a mechanical pointer
 Note 2: For 4 & 6 wire switches replace 3EE by 4EE or 6EE
 Note 3: Manufactured to IP65 (NEMA 4) as standard (up to 2 1/2")

Electrical Options

Code: 3EE
 Basic single pole, double throw, double-break.
 10 Amp - 125, 250 or 480V.AC
 0.5 Amp - 125V.DC / 0.25 Amp - 250V.DC

Code: 4EE
 Contact arrangements are single-pole, double throw and double-break
 10 Amp - 125 or 250V.AC
 0.3 Amp - 125V.DC / 0.15 Amp - 250V.DC

Code: 6EE
 Double-pole, double throw switches simultaneously make and break two independent circuits.
 10 Amp - 125 or 250V.AC
 0.3 Amp - 125V.DC / 0.15 Amp - 250V.DC

Code: AIR
 This system offers an alternative safety arrangement for operation in explosive atmospheres. Compressed air can be used to transmit an on / off signal from the danger area, or to operate a klaxon inside the danger area.

Code: POT
 Remote read-out option (0-10V). Rating to customer's specification, e.g. 1K, 2K etc.

Code: OUT
 A non-contact position encoder gives a continuous 4-20 mA output. Data loggers or recorders can be added to the system.
 The 3 and 6 wire switches described above are available in ATEX approved explosion proof versions, with the appropriate enclosure box. When two or more switches are assembled in one unit, they remain independently adjustable. Re-adjustments may be carried out in the field.

PORT CONNECTIONS

2	= 1/4"	Sizes 1/4" - 2" are screwed or flanged. For flanged bodies, add relevant code letters (shown below)
3	= 3/8"	
4	= 1/2"	
6	= 3/4"	
8	= 1"	

Standard Threads are BSP, not NPT add - N.
 For Wafer connections add W then flange type (e.g. WF10). For flanged connections add one of the following codes:

F10	Alternative pressure ratings in BSEN1092 / DIN2632-5
F16	
F25	
F40	
F150	Alternative pressure ratings in BS1560/ANSI B16.5.
F300	
F600	
FAD	Alternative pressure ratings in BS10
FE	
FF	

For special flange connections, please enquire at factory

VISCOSITY AT OPERATING TEMPERATURE

State units and scale eg. Water is 1 centistoke (cS)
 Maximum rating should not exceed 600cS.

AIR & GAS APPLICATIONS

Flow-Mon flow switches can be used to measure gas flows in exactly the same way as liquid flows. When enquiring for such an application the following information will be required:

- Specify gravity of the gas
- Maximum flow volume
- Operating temperature
- Operating pressure

Switches

Vane style flow meters can be connected to a field adjustable indicator or transmitter suitable for batching, trending, totalising or recording. Available options include:

- SPDT 3 and 4 wire mechanical switch (gold contacts available)
- DPDT 6 wire mechanical switch

- 4-20mA Output
- 0-10V Potentiometer
- Digital Rate Totaliser (Pulse & Modbus options)
- ATEX variants available

Technical Instructions

Installation Instructions

The flow indicators are in-line devices. Mounting can be in any position and no straight length of pipe is required before or after the unit. The unit is installed between two flanges.

Under the Pressure Equipment Directive (PED) these products are pressure accessories, and are not approved for use as safety accessories, as defined by the PED. If used for safety purposes, it is the responsibility of the user/installer to assess the suitability of the product in the pressure equipment or system in which it is used.

It is the responsibility of the user/installer of this equipment to ensure:

1. The product is installed and used by suitably trained personnel in accordance with all relevant local and national regulations and codes.
2. Safe working practices for the media and processes concerned are followed during installation and maintenance.
3. The materials of construction are suitable for the application.
4. The product is protected from fire.
5. The product is protected from impact/vibration.
6. The instrument is only cleaned by washing with detergent. Do not use abrasive cleaners or solvents.
7. For outdoor use in exposed positions, the instrument must be additionally protected/shielded from heavy rainfall.
8. Regular inspection for corrosion/erosion and wear are carried out.

Essential Safety Requirements

1. The instrument must be installed in accordance with the instructions provided.
2. Prior to installation drain pipelines to ensure they are free from any solid particles or pressure.
3. Care must be taken to avoid introducing torsional stress on the instrument when installing into the pipeline. Tighten sufficiently to avoid leaks and check at regular intervals during maintenance.
4. Ensure pipelines are fully primed before commencing normal use.
5. Valves must be opened or closed gradually to avoid shock/vibration.

6. Do not exceed maximum working pressure as stated on the label.
7. Only use with the fluid/gas stated on the label.
8. Do not exceed minimum/maximum working temperature as stated.
9. Do not use instrument if any part of the cable appears to be damaged.
10. Isolate instrument before removing cover.

General Maintenance

1. Remove instrument from pipeline.
2. Remove flanges/bowls by undoing 4 securing bolts, leaving centre housing only (keep enclosure box and spring housing intact).
3. Check for and remove any swarf/foreign body in bowls. Clean if necessary.
4. Remove faceplate and window.
5. Check pointer is still firmly secured.
6. Push open the valve plate (depending on flow rate tension may be high). The valve plate will spring back to 0 when released. Repeat a few times at different points along the scale.
7. Listen/watch the switch to make sure it is activated at desired min/max flow as the valve plate is pushed open. Adjust cam if necessary.
8. **DO NOT** remove or adjust springs as this will affect the calibration of the instrument.
9. Re-assemble instrument. Ensure "O" rings are properly located in grooves and have not been undamaged.

Switch Setting

The cam which operates the microswitch is situated on the spindle behind the pointer and can be adjusted to give an alarm anywhere between zero and max flow. To alter the setting, lift the cam and rotate the cam in the direction required until switch point is located, then gently lower cam in that position.

Changing Box Orientation

1. Remove 4 screws from face. (5/16 Nut Driver)
2. Remove name plate and window.
3. Remove calibrated scale.
4. Remove electrical switch. (screw driver).

5. Remove all 4 Allen Screws (5/32 or 4mm Allen wrench) at base of enclosure and rotate enclosure box to the desired position.
6. Replace 4 Allen screws back into required tapped and tighten control box to meter body.
7. Loosen indicator pointer.

NOTE: If monitor does not have switch(es) skip to #11

8. "Slightly" loosen cam set screw just enough to move cam on dial. (DO NOT LOOSEN DIAL SET SCREW LOCATED BELOW THE CAM). This will make it easier to tighten once switch contact point is set. (1/8 (3.175mm) Allen wrench).
 9. Place switch back into enclosure box and tighten until snug - DO NOT OVER TIGHTEN
- NOTE:** Switch should be wired prior to re-installation
10. Rotate cam to desired set point and tighten Allen screw until snug. Cam will press against the switch roller arm to actuate switch.
 11. Place calibrated scale and tighten back in position.
 12. Move pointer to zero position on calibrated scale and tighten.
 13. Replace faceplate and window.

Troubleshooting

1. In the event of a pointer appearing to stick in one position, remove centre housing and clean away pipe scale to ensure that valve plate is free to return to its seating position. (A spacer can be provided so that the flow can pass through whilst maintenance is being carried out)
2. If the pointer 'trembles', allow flow to continue. Trembling is usually air entrapment and this will be eliminated when the system becomes full.
3. At regular intervals the control valve to the circuit should be closed for one second and then opened to ensure that no large foreign body is holding the vane in one position. The indicator should drop to zero when closing the valve and then when the valve is opened again return to the running flow point. When carrying out this procedure, the indicator will immediately return to a position a little less than the running flow position and slowly return to the correct reading. This is due to the hysteresis of the 'O' rings and spring.

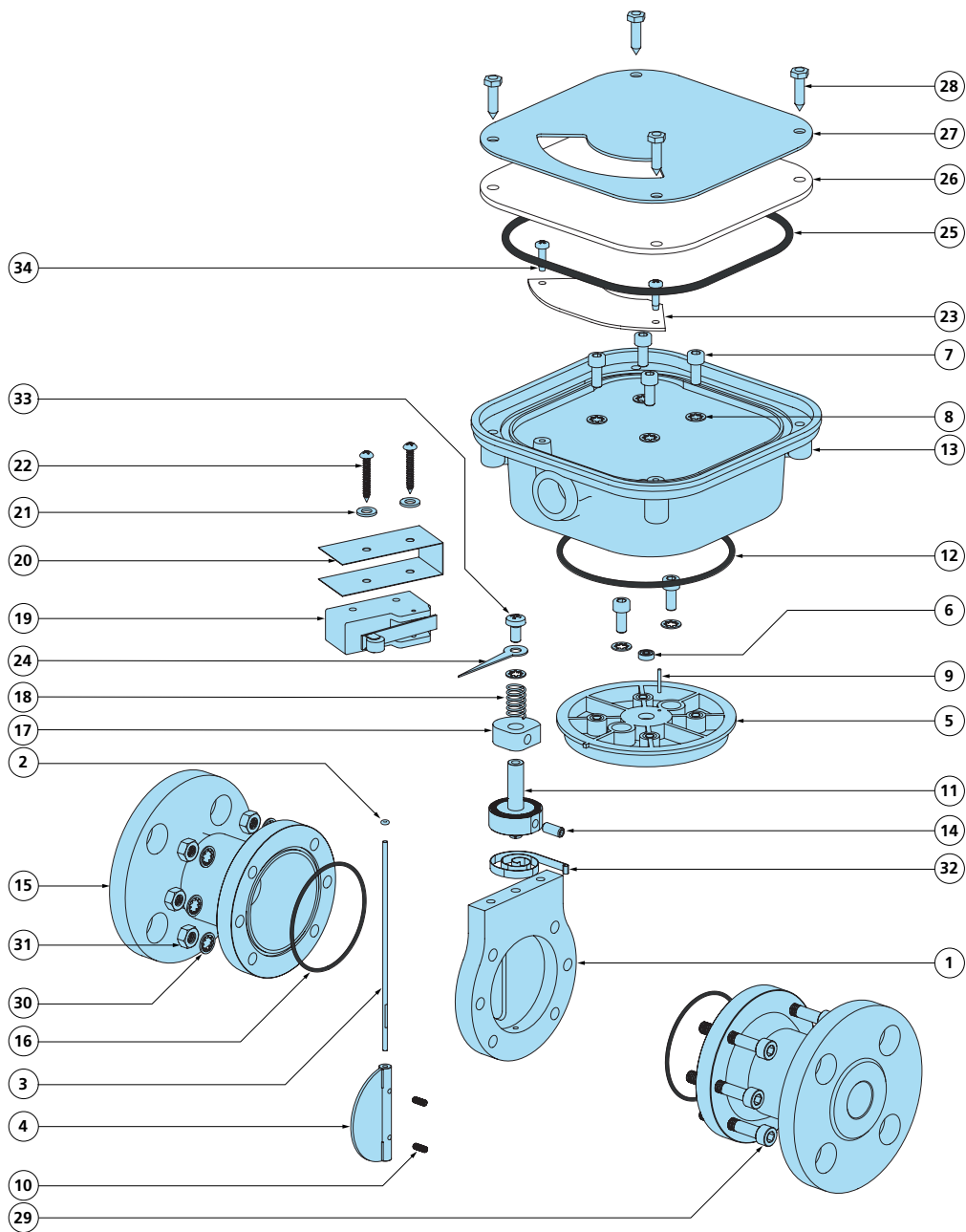

Parts List

Item	Qty	Part No.	Description	Material	Item	Qty	Part No.	Description	Material
1	1	5001	Small Centre Housing	Steel	18	1	5038	Cam Spring	Stainless Steel
2	1	0038	Small 'O' Ring Shaft	Rubber, Black	19	1	2094	3EE Microswitch	
3	1	2180	Small Series Spindle	Steel	20	1	2274	Switch Insulator	Rubber, black
4	1	2203	Small Valve Plate	Steel	21	2	0839	3/16" Zinc Plate Washer	Steel
5	1	5015	Small Series Mounting Disc		22	2	5032	Pozi Pan S/Tapper 6 x 1"	Steel
6	1	2199	Small Bearing	Steel	23	1	5020	Scale Plate	Laminate, White, Matt
7	6	0283x	M5 x 16 Cap Head Screw	Steel	24	1	0165	Pointer	Steel
8	7	0129	5mm Toothed Lock Washer	Steel	25	1	5012	Window 'O' Ring	Rubber, Black
9	1	2211	1/16" Pin	Steel	26	1	5017	Perspex Window	Plastic, Transparent
10	2	5033	Pozi Pan S/Type 6 x 1/2"	Steel	27	1	5018	Face Plate	Aluminium
11	1	2363	Small Indicator Dial	Nylon 6	28	4	5031	Self-tapping screw	Stainless Steel
12	1	5011	Enclosure Lower 'O' Ring	Rubber, Black	29	7	0280	M6 x 40 Cap Head Screw	Steel
13	1	5030	Enclosure Box	Nylon 6	30	6	0023	M6 Lock Washer	Steel
14	1	5037	M5 x 12 grub screw	Steel	31	6	0281	M6 Hex Nut	Steel
15	2	5003	Small Series F150 Flange	Steel	32	1	2272	Small Series Spring (Heavy)	Steel
16	2	2065	Small Bowl 'O' Ring	Rubber, Black	33	1	5035	Cross Recessed Pan Head Screw	Stainless Steel
17	1	2308	Switch Cam	Nylon 6	34	2	2115	M3 x 6 Socket set screw	Stainless Steel