

Agrimag

User Guide

BATTERY POWERED



arkon
flow systems

Arkon Flow Systems

Přízova 1-3, 602 00 Brno, Czech Republic

Tel. +420 543 214 822, Tel./Fax +420 543 215 249

Enquiries/ Orders/ General questions: office@arkon.co.uk

Marketing support/ Brochures: marketing@arkon.co.uk

Technical support: support@arkon.co.uk

www.arkon.co.uk

List of Contents

1. Introduction	3
1.1. Operating Principle.....	3
1.2. Applications.....	3
1.3. Safety Instructions	3
1.4. Unpacking the flowmeter.....	3
2. Installation.....	4
2.1. Sensor Installation.....	4
2.2. Position of flowmeter.....	5
2.3. Connections.....	6
3. Agrimag Unit	7
3.1. Main screen.....	7
3.2. Errors and Warnings	8
4. Battery	9
4.1. Battery Specification.....	9
4.2. Battery life	9
4.3. Changing the battery	9
4.4. Battery conservation	9
5. Internal backup	10
5.1. Automatic data saving.....	10
6. Cleaning.....	10
7. Specifications.....	11
8. Flowmeter Dimensions	12
9. Fittings	13
10. Troubleshooting.....	15
10.1. Trouble: non working display	15
10.2. Trouble: Non stable flow or Empty pipe alarm	16
10.3. Trouble: Error overloaded.....	17
10.4. Trouble: Error excitation.....	18
10.5. Trouble: AD – converter error	18
10.6. Trouble: Low battery error.....	19
11. How to order your Agrimag	19
12. Appendix	20
12.1. Warranty	20
12.2. Contact.....	20

1. Introduction

1.1. Operating Principle

The measurement is based on the principle of Faraday's law of electromagnetic induction where a voltage is induced in an electrically conductive body that moves in a magnetic field. Liquid flows through a tube in the direction of the magnetic field. Liquid with a certain minimum electrical conductivity induces a voltage which is detected by two electrodes located in a 90 degree angle from the magnetic field and the flow direction.

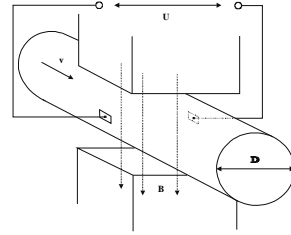

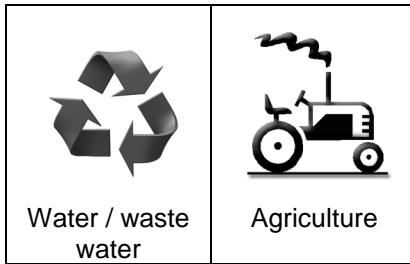

Minimum liquid conductivity	$\geq 20 \mu\text{s} / \text{cm}$
Liquid velocity	min. 0.1 m / sec, max. 10 m / sec.

1.2. Applications



1.3. Safety Instructions

 Please read this manual carefully before using the product.

 Keep this manual for future reference. Arkon Flow Systems, s.r.o will not be liable for any damage caused by improper use of the product or its accessories.

 The Agrimag flowmeter must not be mounted in explosive hazardous areas.

1.4. Unpacking the flowmeter



- ➊ When unpacking the flowmeter, conduct a visual check of the flowmeter upon receipt to make sure the product has not been damaged during transport.
- ➋ Check the completeness of the package. In case of any problem, contact the Arkon sales department without delay.
 - Flowmeter
 - Manual

2. Installation

2.1. Sensor Installation

Proper installation is extremely important in order for your flowmeter to work correctly. There are minimum sensor installation requirements that need to be respected at all Times. Please note that Arkon cannot warranty any installation which does not comply with these requirements.

Horizontal standard mounting

The sensor tube must always remain full. The best way to achieve this is to locate the sensor in a low section of pipe, see the following picture.

It is mandatory to install the sensor in a section of straight pipe with at least 5 times the pipe diameter before sensor and 3 times after sensor.

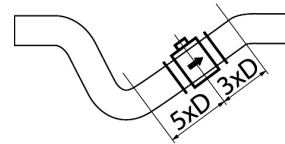
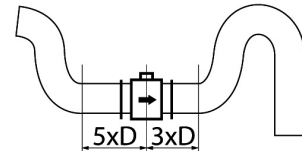

Pipe reducers

If the pipe diameter is not the same as the diameter of sensor, then pipe reducers can be used. So as not to lose accuracy of the measurement, the slope of reducers should not exceed 8° .

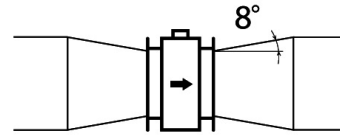

Vertical mounting

When the sensor is mounted on a vertical section of pipe, the flow direction must be upwards. In the case of a downward flow direction, air bubbles can collect in the sensor and the measurement could be unstable and inaccurate.

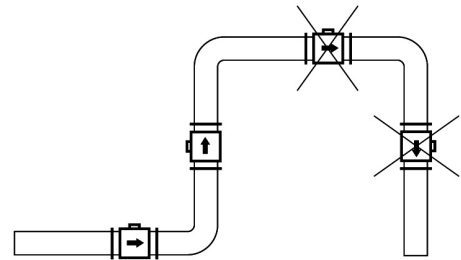

Pumps

Never install the sensor on the suction side of a pump or on a section of pipe where a vacuum is possible.

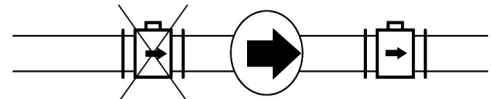

Valves

Suitable location of a shutoff valve is downstream of a sensor.

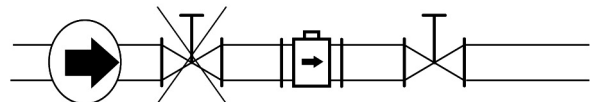

Removal during maintenance

If the application requires removal of the sensor for periodic maintenance, it is recommended to install a bypass section as the drawing below.

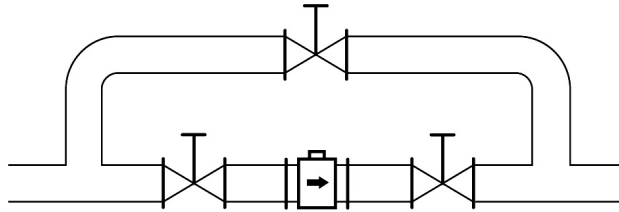

2.2. Position of flowmeter

This is an all position flowmeter which can be installed either vertically or horizontally, register up, down or angled. However, entrained air or solids may make some positions preferable to others. See the position diagram for guidance. The correct position will be related to the function of the electrodes. The two electrodes located on the vertical axis of the flowmeter are used for earthing purposes. The two electrodes located on the horizontal axis of the flowmeters are used for measuring.

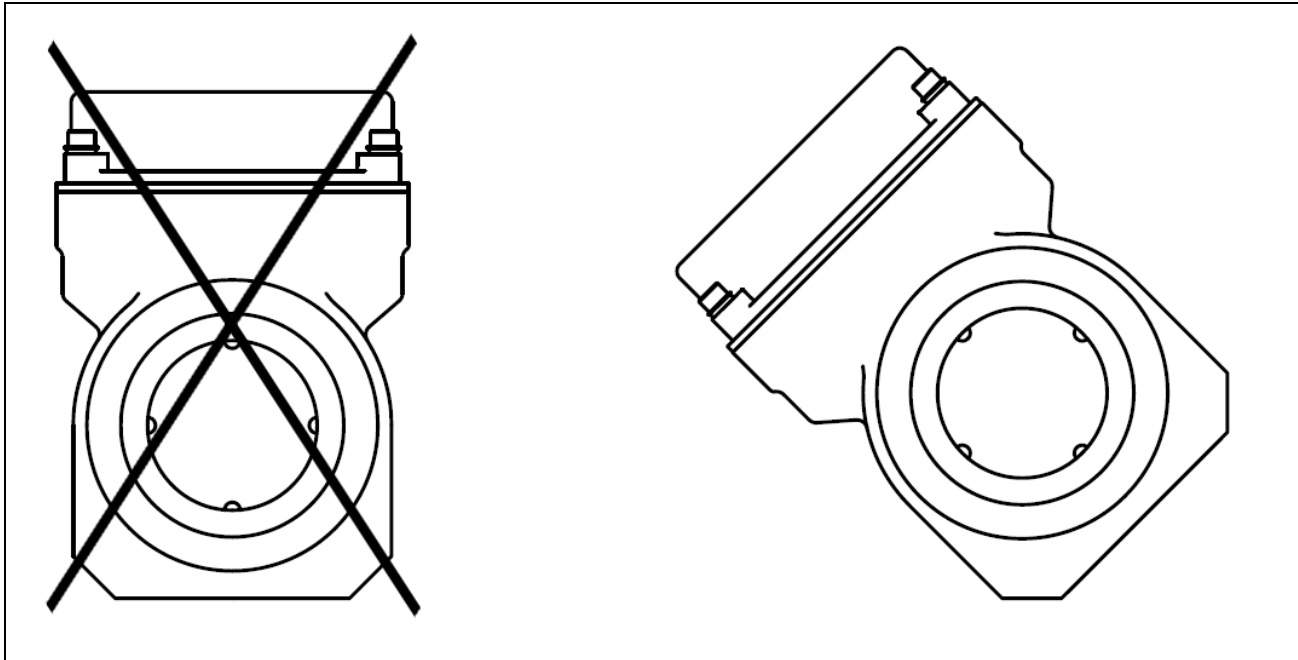



In this position, if there are any air bubbles or if sediments accumulate in the lower part of the flowmeter, it will could have an adverse effect on the earthing, which could influence the accuracy of the measurement.

By rotating the flowmeter, it is possible to prevent the sediments accumulating at the earthing electrodes. Also there is less chance of the air bubbles affecting the earthing electrode.

2.3. Connections

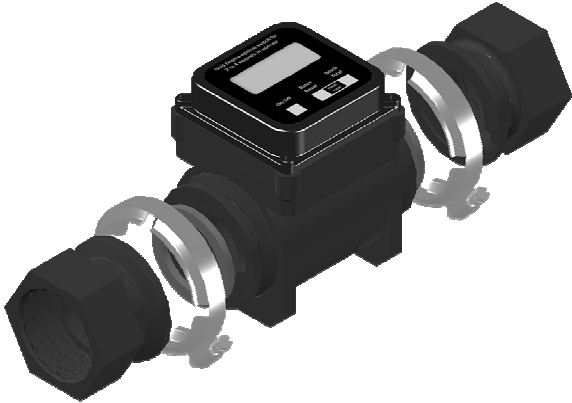
Follow the diagram below to make the connections:

	<p>Step 1 Position gasket at either end</p>
	<p>Step 2 Place adapter against gasket, open screw clamps to clear flanges</p>
	<p>Step 3 Place screw clamps over both adapter and meter flanges and tighten screws</p>

3. Agrimag Unit

The Agrimag flowmeter consists of the motherboard, a graphical display, touch-buttons and sensor housing. Through the display and with help of the controls, you can see and change flow and totalizers. The following symbols are used in this manual and on the flowmeter display.

3.1. Main screen

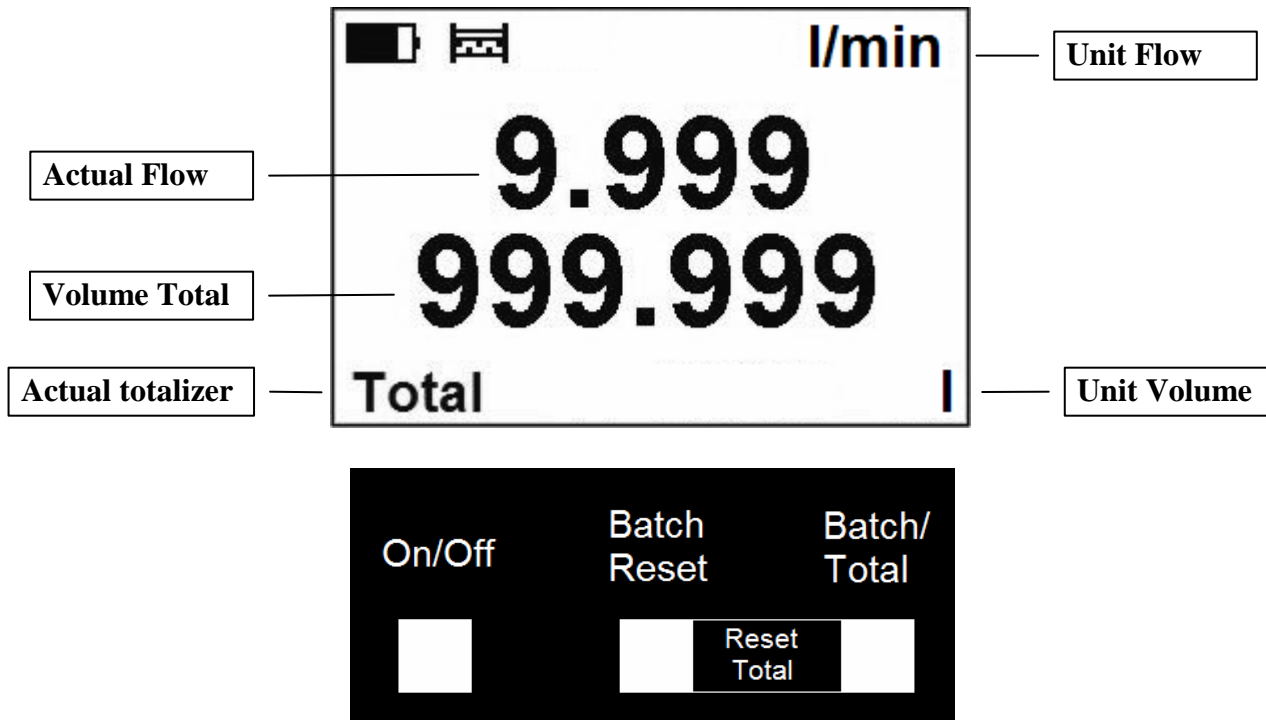

Note: these are not push buttons, to activate hold your finger over the white rectangle for 2 to 4 seconds.

On/Off

Turns the meter on, switching the meter off.

Batch Reset

Clears the Batch volume.

Batch/Total

Switches between totalizers

Combination Batch Reset and Batch/Total together

Clears the Total volume.

Combination On/Off and Batch/Total together

Changes the unit of a system (l/s and USG/min, resp. litres and gallons, etc.)

Total Volume

This is the total volume counter. Negative flow is not counted.*

Batch Volume

This counter works the same way as Total Volume. Both counters are independently clearable.*

*If value of any Volume counter higher than 4 000 000 m3, than value of Volume show only in m3 unit. If value of any Volume counter higher than 999 999 999 m3, then this Volume will be reset to 0

3.2. Errors and Warnings

That is a list of the possible errors for Agrimag:

Low Battery status

If the Low Battery appears on the screen, we recommend that the existing batteries are replaced with new batteries.

Empty Pipe

If the Empty pipe appears on the screen there is no medium in the pipes, the meter is preserving batteries until the pipes are full again.

Excitation

Coils interrupted or disconnected.

AD-converter

AD converter fault.

Note: The error disappears when the cause of it is fixed. You can see the measurement when you touch any of the controls.

Overloaded

That error occurs when the measured flow is bigger than $1.2 * \text{Flow Qn}$. Depending on the size:

Size 25mm: 20.76m³/h

Size 50mm: 81.6m³/h

Size 80mm: 211.2m³/h

Generally that error will occur when the AD converter is overloaded. It can be because on the electrodes are very big voltage or because the flow is really that high.

4. Battery

4.1. Battery Specification

Electrical Specifications	
Size	6x AA size battery
Nominal voltage	1,2-1,6VDC
Operating time	Battery capacity dependent

4.2. Battery life

The battery life can be from 1 year to 3 years depending on measuring or sleeping mode.
The battery operation time depends on ambient temperature, conditions, flowrate profile etc.

4.3. Changing the battery

- 1- Unscrew 4x IMBUS 4 screws.
- 2- Carefully open the display part of the flowmeter.
- 3- Open battery holder and remove batteries.
- 4- Install new six pieces AA batteries 1,2-1,6V.
- 5- Close battery holder.
- 6- Close display part of the flowmeter, mind the cables.
- 7- Tight the 4x IMBUS 4 screws.

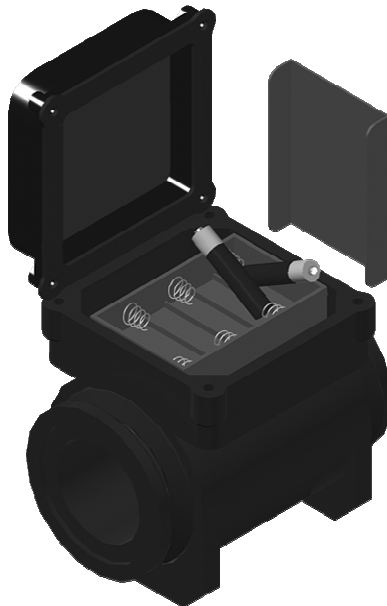

4.4. Battery conservation

The meter switches off after 15 minutes with no flow, the user needs to switch it on again using On/Off button. The battery is also conserved when the Empty Pipe, Excitation and/or AD-converter faults appear.

5. Internal backup

5.1. Automatic data saving

Once an hour some data is saved to the internal EEPROM. These are:

- Total
- Batch

When the batteries are removed, the last Total and last Batch will be saved in the EEPROM until the unit is switched on again.

6. Cleaning

Agrimag electromagnetic flowmeter does not have any moving parts so special maintenance is not required, however we strongly recommend:

1. To check battery life at least once a year and change the 6 batteries if the meter shows "low battery status"
2. Do yearly mechanical cleaning of the sensor to remove any sedimentation from liner or electrodes. That is enough to rub the inside the tube with a piece of emery cloth

7. Specifications

Measurable media	Conductive fluids
Min. Media electrical conductivity	$\geq 20\mu\text{S/cm}$
Flow range	0,1 to 10 m/s
Displayed values	Flow range (m ³ /h, l/s, l/m, US gal/min, UK gal/min), Volume (m ³ , l, US Gal, UK Gal) Total, Batch volume
Accuracy	$\pm 1\%$ of reading from 100% to 10% of full scale $\pm 3\%$ of reading from 10% of full scale to cut-off
Full scale	1": 0.5 – 4.8 l/s 2": 1.9 – 18.9 l/s 3": 5.0 – 49.0 l/s
Power supply	6 AA alkaline batteries, expected lifetime 1 year
Flow direction	Bi-directional measurement
Ambient temperature	- 12 to 54°C (10 to 130°F)
Display	LCD 128 x 64 px graphical, sleep mode
Control	3 touch buttons
Low flow cut-off	2% of full scale
Electronics protection	Nema 4X standard
Other features	Test of excitation coils Earthing through 3rd and 4th electrodes Empty pipe detection - battery conservation
Excitation frequency	1/1,67s
Samples per Average	4 excitations
Coils resistance	100Ω

8. Flowmeter Dimensions

	A	B	C	D	E	F
25 mm	100	130	80	25.4	139.7	41.402
50 mm	100	150	82.55	50.8	139.7	51.562
80 mm	100	180	111	76.2	185	64.8

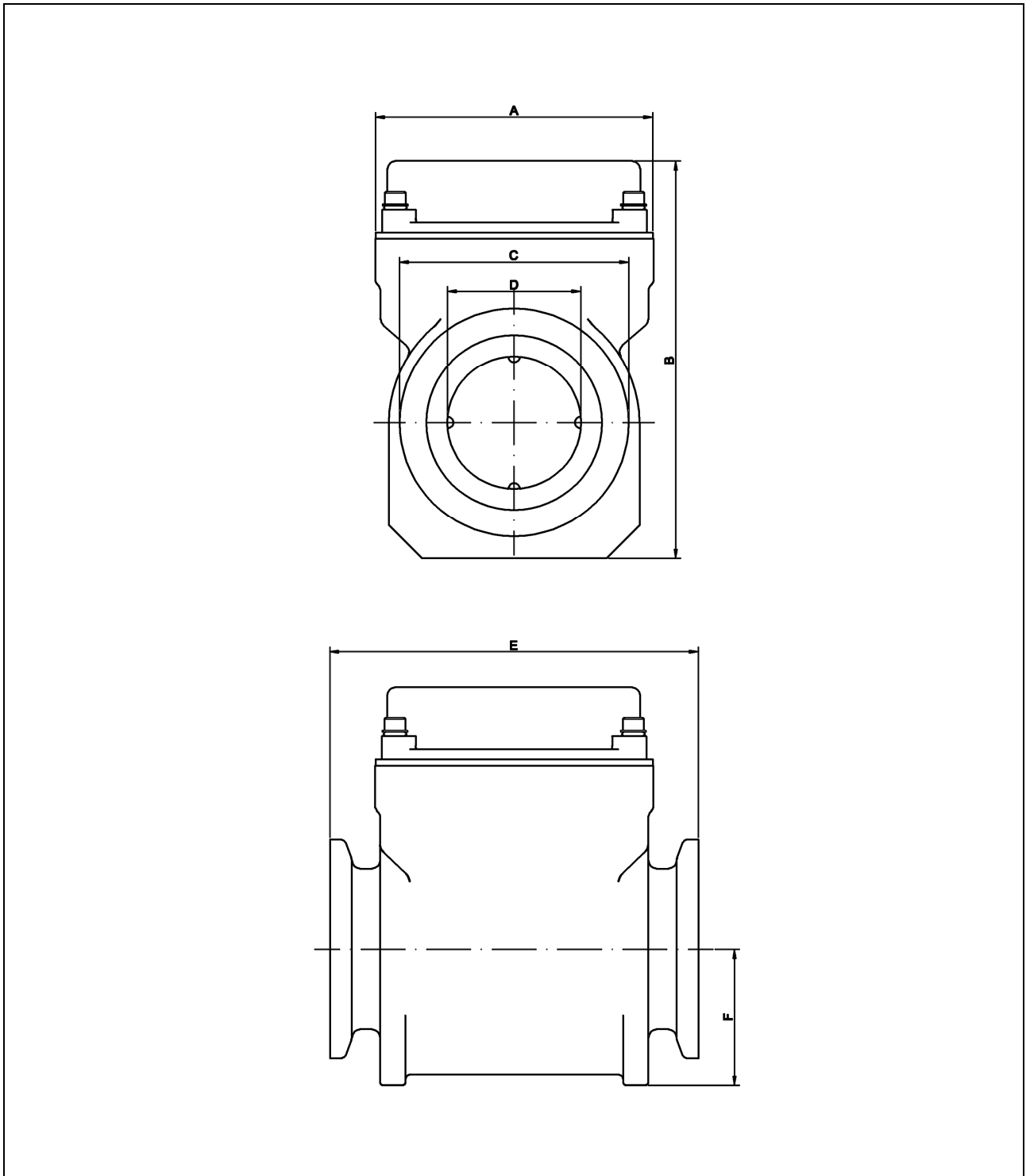

9. Fittings

AGRIMAG SIZE		
25 mm		
PIPE CONNECTION	PART NUMBER	DESCRIPTION
Male BSP	M100BSP	1" Manifold x 1" Male BSP
Female NPT	M100050FPT	1" Manifold x 1/2" Female NPT
	M100075FPT	1" Manifold x 1" Female NPT
	M100FPT	1" Manifold x 1.1/4" Female NPT
Male NPT	M100075MPT	1" Manifold x 3/4" Male NPT
	M100MPT	1" Manifold x 1" Male NPT
	M100125MPT	1" Manifold x 1.1/4" Male NPT
Male NPT 316SS	M100MPTSS	1" Manifold x 1" Male NPT SS
Flanged Couplings	M100CPG	1" Manifold x 1" Manifold
Male QDC	M100A	1" Manifold x 1" Male QDC
Hose Barb	M100075BRB	1" Manifold x 3/4" Hose Barb
	M100BRB	1" Manifold x 1" Hose Barb
	M100125BRB	1" Manifold x 1.1/4" Hose Barb
Socket weld 316 SS	M100SWFSS	1" Manifold x 1" Socket weld fitting

50 mm		
PIPE CONNECTION	PART NUMBER	DESCRIPTION
Male BSP	M220BSP	2" Manifold x 2" Male BSP
Female NPT	M220FPT	2" Manifold x 2" Female NPT
Male NPT	M220MPT	2" Manifold x 2" Male NPT
Male NPT 316SS	M220150MPTSS	2" Manifold x 1.1/2" Male NPT SS
	M220MPTSS	2" Manifold x 2" Male NPT SS
Flanged Couplings	M220CPG	2" Manifold x 2" Manifold
	M220CPG6	2" Manifold x 2" Manifold x 6" long
Female QDC	M220D	2" Manifold x 2" Female coupler QDC
Male QDC	M220A	2" Manifold x 2" Male QDC
Hose Barb	M220125BRB	2" Manifold x 1.1/4" Hose Barb
	M220150BRB	2" Manifold x 1.1/2" Hose Barb
	M220BRB	2" Manifold x 2" Hose Barb
Socket weld 316 SS	M220SWFSS	2" Manifold x 2" Socket weld fitting
	M220375SWFSS	2" Manifold x 2" Socket weld Fitting 3.3/4"

80 mm		
PIPE CONNECTION	PART NUMBER	DESCRIPTION
Male BSP	M220BSP	2" Manifold x 2" Male BSP
Female NPT	M300BSP	3" Manifold x 3" Male BSP
	M300FPT	3" Manifold x 3" Female NPT
Male NPT	M300MPT	3" Manifold x 3" Male NPT
Male NPT 316SS	M300220MPTSS	3" Manifold x 2" Male NPT SS
Flanged Couplings	M300MPTSS	3" Manifold x 3" Male NPT SS
	M300CPG	3" Manifold x 3" Manifold x 4" long
Female QDC	M300CPG7	3" Manifold x 3" Manifold x 7" long
Hose Barb	M300A	3" Manifold x 3" Male QDC
	M300220BRB	3" Manifold x 2" Hose Barb
	M300BRB	3" Manifold x 3" Hose Barb
Socket weld 316 SS	M300SWFSS	3" Manifold x 3" Socket weld fitting
	M300375SWFSS	3" Manifold x 3" Socket weld Fitting 3.3/4"

Clamps and gaskets						
	PART NUMBER	Size 25mm	PART NUMBER	Size 50mm	PART NUMBER	Size 80mm
Clamp	FC100	Pair	FC220	Pair	FC300	Pair
Gasket	M101G	Pair EPDM	M221G	Pair EPDM	M301G	Pair EPDM
	M100GV	Pair Viton	200GV	Pair Viton	M301GV	Pair Viton

Example of fitting kit

All the fitting kits except the spare clamp pair and spare gasket pair includes:

2 fittings parts + 2 clamps + 2 gaskets.



10. Troubleshooting

10.1. Trouble: non working display

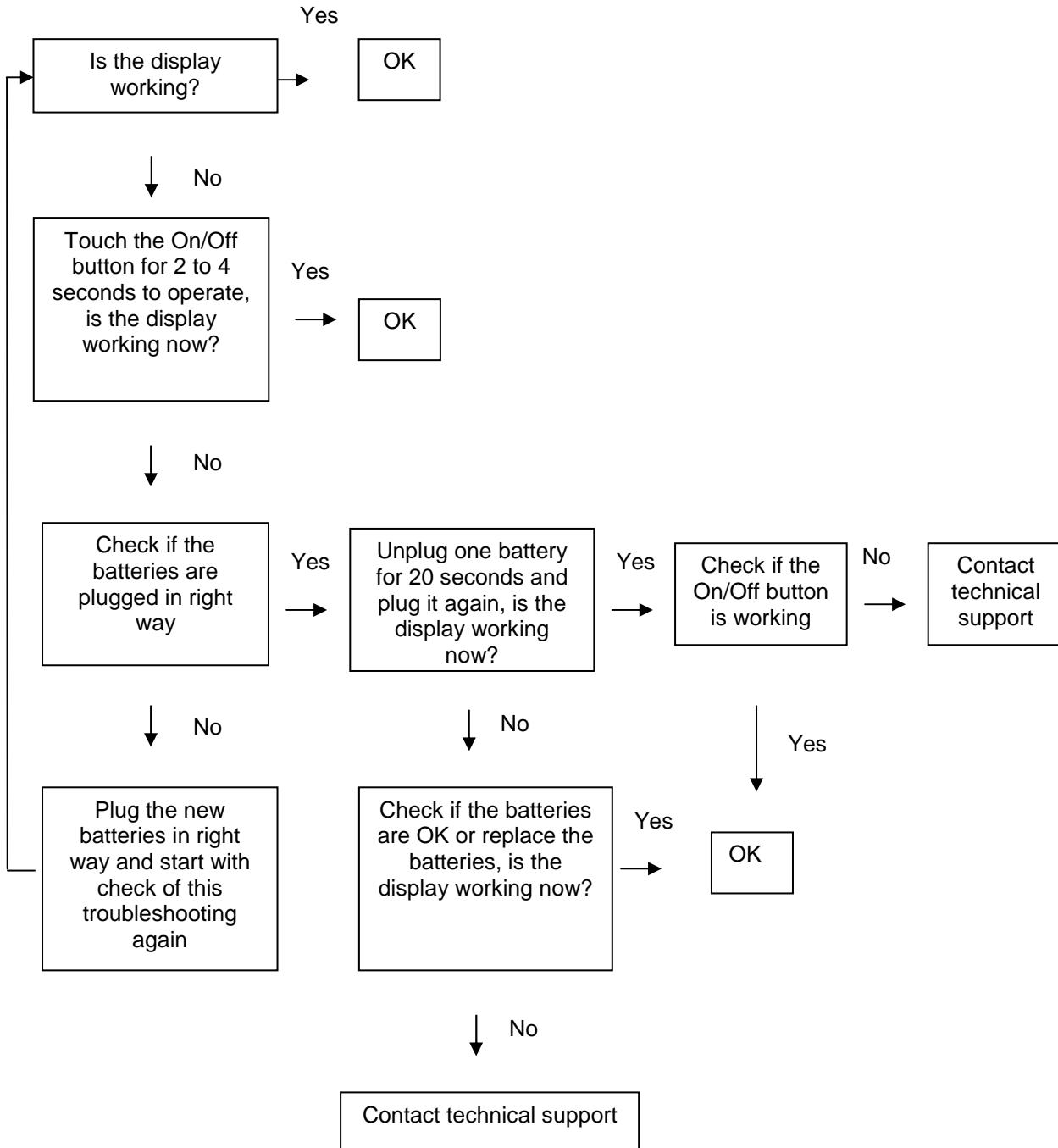

10.2. Trouble: Non stable flow or Empty pipe alarm

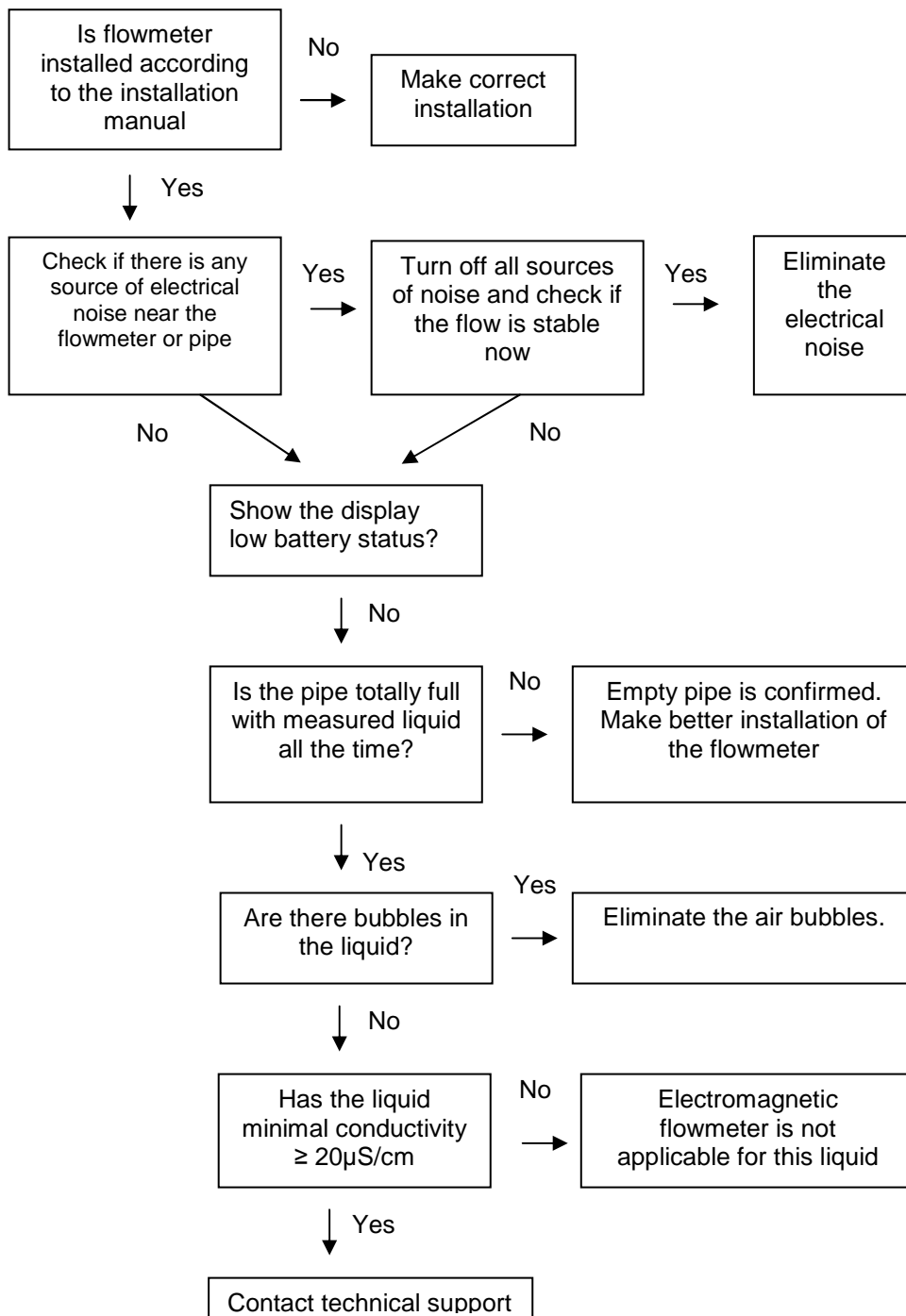
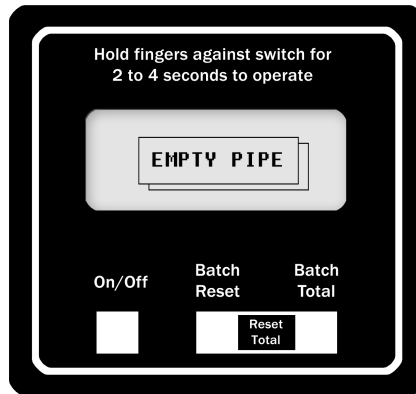

10.3. Trouble: Error overloaded

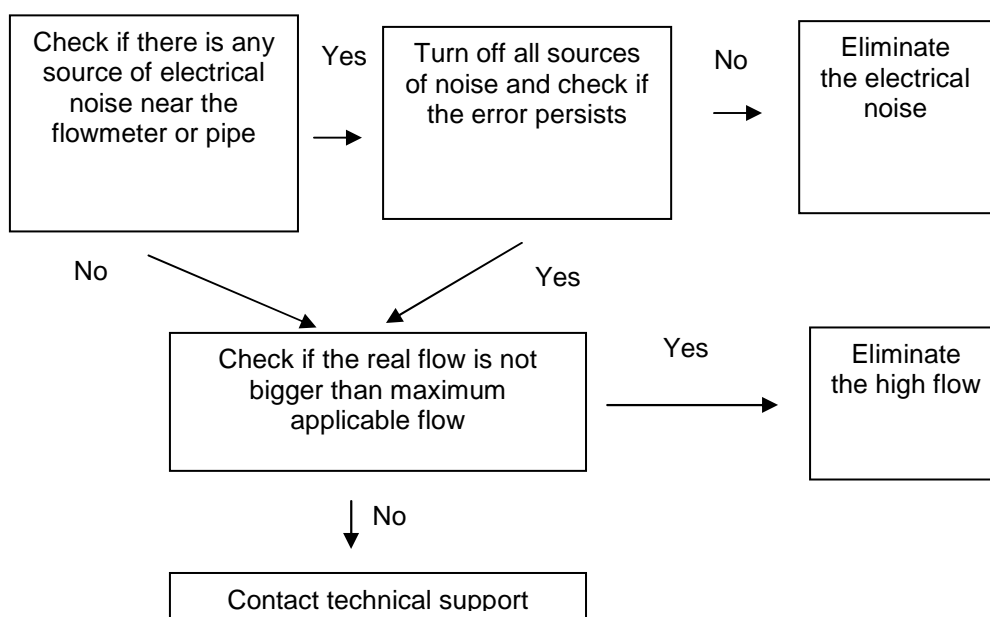
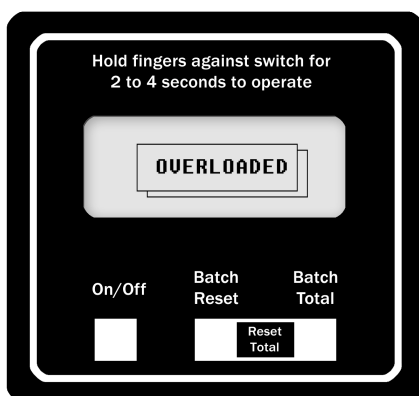

10.6. Trouble: Low battery error

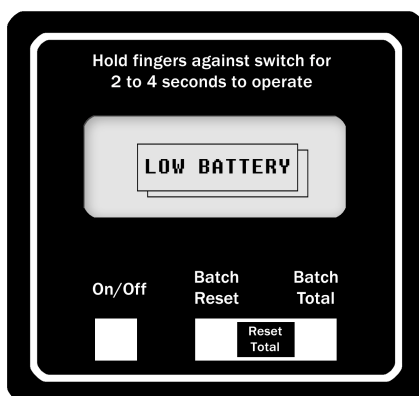

Replace the batteries. Install correctly

11. How to order your Agrimag

Model	Ordering code		Description
Agrimag	1	2	
			<i>Size</i>
	25		25mm
	50		50mm
	80		80mm
			Connections
		NPT	NPT female
		MAN	Manifold

Example

Agrimag	25	NPT
---------	----	-----

12. Appendix

12.1. Warranty

The warranty conditions are covered by Arkon Flow Systems, s.r.o. Terms & Conditions of Sale and by Arkon Flow Systems, s.r.o Return Regulations and Warranty Conditions. The Arkon Flow Systems, s.r.o Terms & Conditions of Sale and the Arkon Flow Systems, s.r.o Return Regulations and Warranty Conditions are an integral part of the Resellers contract and of any Order Confirmation. Please see your Resellers contract or www.arkon.co.uk; Support section. The Warranty sheet is part of the Packing note of any new goods sent. For the claim or return procedure, please consult our web site www.arkon.co.uk or call the Arkon Flow Systems, s.r.o sales office.

12.2. Contact



Technical support: support@arkon.co.uk
Windows life messenger: support@arkon.co.uk

Sales office: office@arkon.co.uk

Office hours:
8:30 – 18:00 (GMT+1)

Direct technical support:
8:00 – 17:00 (GMT+1)